

# disk

## USER

**BBC MICRO  
MODEL B  
MODEL B+  
MASTER I28**

ALL DFS  
FILING  
SYSTEMS

**BURSTING WITH GOOD IDEAS FOR YOUR BBC**

**HOT KEY UTILITY!**

**CAREWARE – PSYCHEBROT'S NEW CONCEPT  
SCHIZOSCREENIA – SIMULTANEOUS SCREENS  
ON-SCREEN TUTORIAL – GRAPHICS FROM BASIC  
THOUGHT-PROVOKING AND ORIGINAL GAMES**

**PLUS:**

MUSIC  
ANIMATIONS  
UTILITIES  
BEGINNER'S GUIDE TO DISKS  
NEWS, REVIEWS, DISCUSSION

**NOW MONTHLY!**

By popular demand

# disk USER

is  
**NOW MONTHLY**  
NEXT ISSUE OUT ON APRIL 15TH

For **INSTANT, ENTERTAINING**  
and **USEFUL** software you only  
need to know about two keys

**SHIFT and BREAK**



- **Just BOOT for instant magazine action.**
- **Disk User – the unique interactive magazine on disk.**
- **FULL to brimming with BBC BASIC and machine code software**
- **AND graphics, demos and adverts on disk**

**PLUS** pages full of reviews, hints and tips and tutorial on how to use your disk system effectively.

In the 1987 Magazine Publishing Awards organised by The Publisher, Disk User for the BBC Micro won a second place certificate. The experienced panel of judges praised the "sheer value of the cover-mounted disk that formed part of the new publication's concept".

**JUST LOOK** at what we've in store for you next MONTH

- **SYSTEM WADGEBURY.** Exceptional gameplay in this humorous multi-screen monster.
- **DESKTOP POPUPS.** Handy and helpful utilities for the home office.
- **PLUS** all the regular features

## SUBSCRIBE NOW!

We've made it easy to subscribe to Disk User. You can choose from a 6 monthly or 12 monthly subscription. Twelve disks full of quality software PLUS colourful magazine for just £35.40.

	6 months	12 months
UK	£17.70	£35.40
Europe	£21.60	£42.00
Middle East	£21.70	£43.40
Far East	£23.20	£46.40
Rest of the World	£22.00 or USA \$32.00	£44.00 or USA \$64.00
Airmail rates given on request		

**Disk User  
Number Six  
April 1988**

Editor: Mark Webb  
Editorial Consultant: Andrew Brown  
Software Consultant: Matthew Fifield  
Advertisement Manager:  
Sarah Musgrave  
Advertisement Copy Control:  
Francisca Perez

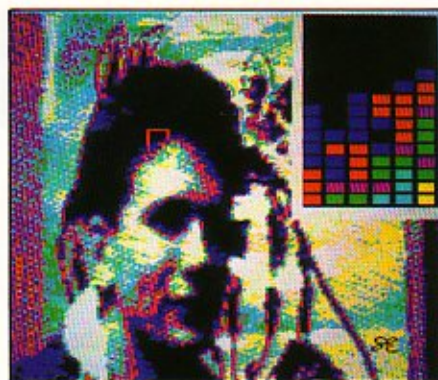
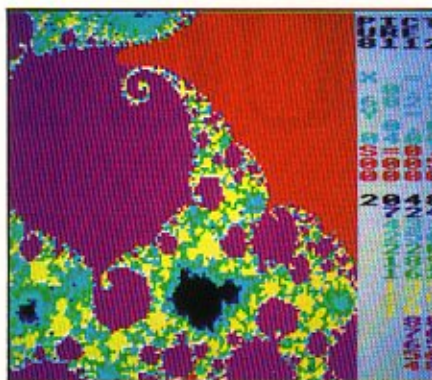

## IN THE MAGAZINE

**Disk Instructions 4**

How to get the best out of Disk User – including 40 to 80 track conversion. Make sure you get the full picture by reading these pages before using your Disk User disk

**Disk News 6**

Latest releases and news for disk users

**Discussion 8**

Your letters column

**Beginners Guide to Disks 16**

Tracks and sectors explained and why your disk needs a catalogue

**Magic Wall Solution 21**

Couldn't crack it? Tetris eat your heart out

**Transfer 23**

Getting the best from your copy of Disk User and how to use the menu program

**Floppy Fun 27**

Dave Reeder with a solution to Palace of Magic

**Painting the Town 28**

Achievements in graphics with BBC Micro software and peripherals

**Disk Data 30**

BeebDos gives an IBM PC BBC Disk File compatibility. How does it do it?

## DISK DOCUMENTATION

**ALL MODEL B, B+ and Master Series compatible**

**Psychebrot 10**

Find out about Careware and view these stunning Mandelbrots and special effects

**Graphics from BASIC 14**

Ellipse tutorial with disk based exercises

**Blobber 17**

You'll need your wits about you to complete this arcade game

**Martian Nim 19**

Strategy with a difference

**Pixel Perfect 19**

Pixel level editing of colour graphics

**Collectors Items 22**

Animations for you to copy and keep. Build a collection from this entertaining A to Z of animations by computer artist Abbas

**Schizoscreenia 25**

Lets you work in two screen windows

**Zoom Lens 26**

Enlarge or reduce any part of a graphics screen

**Hot Key! – Anytime Anywhere 31**

Instant access to OS commands

## ELECTRON COMPATIBLE:

- Disk menu
- Martian Nim
- Psychebrot mandelbrots
- Brian Clough's Football Fortunes Demonstration
- Ellipse tutorial
- Zoom Lens graphics utility

Disk User is published monthly on the third Friday of the month preceding cover date. Editorial and advertising enquiries to Disk User, Number One Golden Square, London W1R 3AB. Telephone: 01 437 0626. Distributed by SM Distribution Ltd., 16-18 Trinity Gardens, London SW9 8DX. Telephone: 01 274 8611.

Contributions should include full source code and instructions file on disk. Payments are extremely competitive.

The contents of this publication including all articles, designs, plans, drawings and programs and all copyright and other intellectual property rights therein belong to Argus Specialist Publications Ltd. All rights conferred by the Law of Copyright and other intellectual property rights and by virtue of international copyright conventions are specifically reserved to Argus Specialist Publications Ltd. Any reproduction requires the prior written consent of Argus Specialist Publications Ltd.

Typeset and artwork by Island Graphics. Cover design and design by the ASP Design Studio.

Origination by Croxsons of Chesham.

Printed by Chase Web, Devon.

Duplication by DisCopy Labs, 20 Osyth Close, Brackmills, Northampton, NN4 0DY. ISSN 0953-0606

© Argus Specialist Publications Ltd 1988

Disk User is supplied on a 40 track disk format and can be run without conversion on a 40 track drive.

If you have 40/80 switchable drives then make sure the drive is switched to the 40 option.

For 80 track only drive owners, a conversion program is provided – see Disk Instructions.

All files can be copied to and used on ADFS systems.

# DISK INSTRUCTIONS

## DISK INSTRUCTIONS

To get the best from your copy of *Disk User*, please carefully read the instructions below. We have made *Disk User* able to run on a very wide range of systems.

### All Users

Please make a **Backup copy** and keep the original in a safe place with a Write-Protect tab on. You should use this copy as your working copy, as many of the programs need to write to the disk, and doing this will diminish the usefulness of the original, and may not be possible anyway due to the 31 file limit imposed by many DFS's.

### New Users

If you are a new user **Don't Panic!**, first find out whether you have 40 or 80 track drive(s) attached to your computer (ask someone knowledgeable if you don't know). Then go to your User guide or Welcome Manual and read the chapter on filing systems. In particular find out how to use the \*COPY command or what program performs the same function on your Utilities disc if there is no \*COPY. Next re-read the section above **All Users**, and then go to the appropriate section dealing with your particular filing system and follow the instructions listed there.

### Advanced Users

You do not need help to run *Disk User*, but do refer to the instructions for the filing system you are using, and **Don't forget to make a Backup copy.**

### 40 Track Drive Systems

*Disk User* is supplied on a 40 track disk so will work on any 40 track BBC micro system (at least, any that we know of!) straight away. Remember to make a working copy before use.

### 40/80 Switchable Drives

If you have this sort of drive, you can

use *Disk User* straight away with the drive switched to the 40 track setting; don't forget to make a copy for normal use. However, you may wish to copy the disk on to 80 track format, in which case, with a single drive, you should follow the instructions for 80 track systems.

With two switchable drives, or one switchable drive set to 40 track and an 80 track drive (or even a 40 track drive and an 80 track drive), you can easily copy *Disk User* on to 80 tracks; put *Disk User* into drive 0 (40 tracks) and a blank formatted 80 track disk into drive 1 (80 tracks) and type:

```
*COPY 0 1 *.*<RETURN>
```

Here <RETURN> means hitting the return key. You can set the boot option to drive one by typing:

```
*DRIVE 1<RETURN> *OPT 4 3<RETURN>
```

### 80 Track Drives

Because *Disk User* is supplied as a 40 track disk, 80 track disk drives have to double-step through the disk. Probably the most convenient thing to do is to copy *Disk User* on to 80 track format. This can be done in two ways.

If your filing system allows double-stepping, we recommend using the system's own command. As a general rule, built-in 40-to-80 track converters should be used where available; the documentation for your filing system or utility ROM will give full instructions, and we give suggestions for some better-known systems further on).

Not all filing systems have facilities for double-stepping; Acorn's DFS is one such system. To overcome this, a program called CHANGE is supplied on the *Disk User* disk in a section which can be accessed by 80 track drives.

### Using CHANGE

Insert *Disk User* into an 80-track drive (or 40/80 switched to 80-track) and type: \*CHANGE <RETURN> The program will prompt you to

insert a pre-formatted blank 80 track disk when it is ready to write to it (you will have to swap back and forward between the two disks several times if you are using only one drive). Once this is completed, you can use the newly created 80-track version of *Disk User* and keep the original as the back-up.

Our suggestions on how to use *Disk User* on some popular DFSs now follow.

### Master 128

This Acorn DFS has a software double stepping mode for a 80 track drive. Set it with the command \*DRIVE 0 40 <RETURN> and then hit <BREAK>

*Disk User* will then work without any need for conversion. However this may not allow writing to the disk in 40 track mode; in any case, you should make a working copy, so copy to a 80 track disk.

### DFS on Master Compact

The DFS is supplied as an image on some versions of the Master Compact Welcome disk (or is available from Acorn on disk) and this may be used in conjunction with a 5¼ inch 40 track disk drive to run *Disk User*. Please note that we **cannot** at present supply *Disk User* on a 3½ inch disk (if there is sufficient demand, we may be able to in the future).

### Opus DDOS/Challenger 3

If you are using the Opus DDOS disk filing system or Challenger 1.0/DDOS then issue the command \*4080 AUTO <RETURN> or \*ENABLE 40/80 <RETURN> and *Disk User* will work without any need for conversion.

### Challenger 3

If you have the later ROM version Challenger 1.1 then issue the command \*OPT 8,1 <RETURN>

to achieve the same result. Disk User will work effectively from the RAM disk. Use

**\*COPY 0 4 \*** **\*CONFIG 4=0 0=4**  
**\*OPT 4 3**

to run from RAM disk

### Solidisk DFS

With the Solidisk DFS 2.1 and 2.0 you can set a software double stepping mode for a 80 track drive with the command

**\*ENABLE 80 <RETURN>**

Disk User will then work without any need for conversion.

### Watford DFS

The Watford DFSs also have a software double stepping mode for an 80 track drive. Consult your manual for the appropriate FX call or command. Disk User will then work without any need for conversion.

### Disk failure

If for any reason your copy of Disk User will not work on your system then please carefully re-read the instructions given above.

If you still experience problems then:

1. If you are a subscriber, return it to: **Disk User, Infonet, Times House, 179 The Marlowes, Hemel Hempstead**

2. If you bought it from a newsagents, return it to **Disk User Replacements, Discopy Labs, 20 Osyth Close, Brack Mills, Northampton NN4 0DY.**

Please use appropriate packaging, cardboard stiffener at least, when returning a disk. Also please mark the envelope **Disk User** Do not send back your copy of the magazine. Only the disk please.

### Technical Enquiries

You can make telephone enquiries about *Disk User* on 0733 53355 (please ask for *Disk User* Editorial). Enquiries in writing to the following address: **Phoenix Software, 6C Belgic Square, Off Padholme Rd, Peterborough PE1 1XF**

### Disk User files

All change - 40 track to 80 track convertor.

Files :-

CHANGE - Machine code file.

To use type **\*RUN CHANGE**

**<RETURN>**

Disk User - Disk magazine title page animation (yes we know it goes in backwards!).

Author : Abbas Files :-

P.RUNDISC - BASIC program

A.DISC - Machine code file

Menu - Easy selection of the software.

Author : Matthew Fifield Files :-

MENU - BASIC program

Theme Music - Groovey tune to get you in the mood.

Author : Ian Waugh Files :-

LOADER - BASIC program

Theme - Data file

Martian Nim - The classic game played by aliens.

Author : David Bartrum Files :-

MARTIAN - BASIC program

Psychebrot - A colourful and relaxing fractal display.

Author : Chris Reynolds Files :-

EXPAND - BASIC program

COMPSY - Compacted files

PSYDOC - BASIC program

Schizoscreenia - A divisive influence on your V.D.U.

Author : R. Hughes Files :-

S.SplitSc - BASIC and assembler

Split - Machine code file

Brian Clough's Football Fortunes Demonstration - If you like what you see BUY IT!

DEMO - Machine code file

Graphics from BASIC - Learn about digital generation of elliptical curves.

Author : Simon Fifield Files :-

ELPTUT - BASIC program

Zoom Lens - Reduce or enlarge any picture on your screen.

Author : Tim Powys-Lybbe Files :-

Scaler - Machine code file

Pixel Perfect - Mode 2 screens come under close scrutiny.

Author : Stephen Ellis Files :-

PIXEL1 - BASIC and Assembler

PIXEL2 - BASIC and Assembler

PIXEL3 - Data file

Hot Key - Issue operating system commands from a single hot key.

Author : Mark Gidley Files :-

+ .InsntOS - BASIC and assembler

Collectors Items - A giant amongst animations.

Author : Abbas Files :-

P.RUNg - BASIC program

G.ALPHA - Animation data file

Blobber - Help Blobber collect his strawberries.

Author : John Cassar Files :-

BLOBBER - BASIC program

BLOB2 - Machine code file

RELOC - Machine code file

Paint The Town - Not just a pretty face!

Author : Micro Studio Files :-

CUT - BASIC Program

C.ASSRTED - Compressed data file

### ADFS Users

All files on this disk work on the ADFS.

**Note:- Disk User 6 almost fills a 40 track disk. Any software that may need extra disk space to save information must be copied onto a blank disk. ie Split Screen, Scaler and Psychebrot.**

# DISK NEWS

## Double View

Tubelink have produced an extension ROM for the View word processor and Viewsheets spreadsheet.

*DoubleView* offers a split screen with a continual display of free memory, file name, printer driver name, and marker numbers.

*Doubleview* also enables the user to work on two documents at the same time with a cut and paste clipboard. The software is only available on the Master and the Master Compact. Model B owners might like to try our split screen utility!

## New challenge

Slogger the company well known for its support for the Electron have released a new series of Challenger products.

Their RAM disk is "fully Acorn DFS and now ADFS compatible". It comes in a number of configurations: 256K, 512K, 768K and 1024K - prices range from £120 to £199 plus VAT.

Owners of the *Challenger* RAM disc systems need not get too peeved because Slogger have also announced a series of upgrade kits for the Challenger 3 and 4. The 1Mhz bus through socket supports other devices although we haven't yet tested winchester drives or Music 5000. Check with Slogger first.

## Economy "Eagles"

Parrot have their new range of economy disks called "Eagle" disks - nice packaging, but more importantly a nice price - pitching these disks fairly and squarely at educational establishments, small businesses and home users.

## Geordie Racer

Latest additions to the BBC soft catalogue come in the form of *Geordie Racer* and *Bird Spy*.

*Geordie Racer* is based on the BBC School's TV series *Look and Read*, while *Bird Spy* is a must for all young bird watchers. It has been produced in association with the BBC Radio series *Looking at Nature*. Price £14.95.

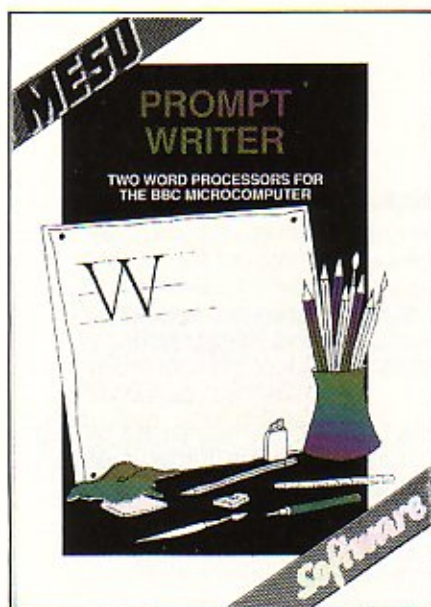

## Progressive wordprocessing

MESU (Micro Electronics Support Unit) is the government organisation based on the campus of Warwick University whose job it is to develop the use of information technology in our schools. Part of that task involves publishing educational software and one of their latest releases is the wordprocessor combination of *PROMPT* and *WRITER*.

These wordprocessors are aimed at teaching familiarity with word-processing and they are especially valuable for young children when used in conjunction with a Concept Keyboard. Anyone working with the menus in *PROMPT*, a very supportive piece of software, can move with ease up to the more powerful *WRITER*.

MESU Primary Project  
MESU Special Needs Software Centre  
© MESU 1987

Filename: ALPHBET

a	b	c	d	e	f	g	h
i	j	k	l	m	n	o	p
q	r	s	t	u	v	w	x
y	z	.	'	CAPITAL	RETURN	←	→
		?	!	SPACE	DELETE	↑	↓

**MESU Keyboard Overlay PROMPT / WRITER**

---

MESU Primary Project  
MESU Special Needs Software Centre  
© MESU 1987

Load the writing "WHOTSIT".  
Finish the descriptions by pressing on the right word.

Filename: WHOTSIT

DELETE	RETURN	←	→
SPACE		↑	↓

**MESU Keyboard Overlay PROMPT / WRITER**

**Display time**

Signwriter, from Wight Scientific, prints large letters, with boxes and special character fonts, for notices, posters, indeed any display that needs clear and visible text. The fonts could also be used in combination with other packages for desk top publishing purposes.

The master disk contains the program in which the sign is set up with specific characters and box styles. It also contains a font editor for creating your own characters or logos and one main font. Further fonts are available at £5.00 + VAT plus the cost of a new disk. They include icon font and dawn font, both displayed here.

**Personal accounts**

Small business users of the BBC disk system will be interested to hear that Minerva Systems have extended their range of applications programs based on the System Delta ROM. Personal Accountant is a five disk pack with order processing/invoicing, purchase ledger, nominal ledger, sales ledger and stock management.

All the modules are menu driven and simple to use in conjunction with excellently produced individual manuals. The relational database system is ideal for cross referencing the different elements of the business software.

**NOW IS THE TIME  
FOR ALL GOOD MEN  
TO COME TO  
THE AID  
OF THE PARTY.**

**Educational database**

Those using their BBC Micros for educational purposes will be interested to hear of a database of useful educational contact addresses (700) and software packages (2600). It's been put together by Nick Evans of Doncaster based educational publisher RESOURCE. The data is in a form suitable for Viewstore although it can be exported to any intelligent database system.

Both sets of data are broken up into useful categories such as library, life skills, careers and conference, HMI and IC design.

**Disk Data**

Tubelink PO Box 641, London, NW9 8TF. ☎ 01 205 9393.

Slogger, 107 Richmond Road, Gillingham, Kent, ME7 1LX. ☎ 0634 52303.

MESU, Unit 6, Advanced Tecnology Building, Sier William Lyons Road, Science Park, University of Warwick, Coventry CB4 7EZ. ☎ 0203 416994.

Wight Scientific, 44 Roan Street, London SE10 9JT. ☎ 01 858 2699.

Minerva Systems, 69 Sidwell Street, Exeter, Devon, EX4 6PH. ☎ 0392 37756

# DISCUSSION



## Electron Compatibility

*I have recently bought a copy of your magazine and I must commend you on its presentation and format. I am running your disk on an Acorn Electron with Cumana disk interface and 40 track single sided, single density drive. I have converted from the Acorn DFS to Cumana DFS and have had some success in running programs. Is there any chance of complete Electron compatibility for Disk User?*

*Andy Hiller Exeter*

*PS Yes, I know the ultimate answer is to buy a Master!!*

*Not complete compatibility I'm afraid but we do test all Disk User*

programs for Electron compatibility. We test on Cumana, Slogger and Advanced Computer Products systems. Naturally we would not wish to change BBC programs if it means loss of performance but, as you have discovered, many programs can be made to work, with little or no differences, on the Electron. The sort of program that will never work is the Mode 7 animation. Sound is also a potential problem unless, like D.Ingleby-Oddy, who wrote to use from Truro in Cornwall, you design your own sound expansion unit, so that you can hear the Disk User theme tune properly!

In this issue you will note that we have listed the Electron compatible programs on the contents page. Others are easily convertible eg Hot Key uses the "@" key to generate the instant command. This key is unavailable on the Electron. A quick look at the source code and

your manual and you can change the key code to a more suitable key (but one not often used) like "J". Split screens is the same, using "TAB" as a switch between the two windows. The source code is supplied so load it up and change the key code.

For the future we will be making this kind of change, where possible, to increase the number of programs available to Electron users. So keep your eyes open for Disk User, there will always be something useful or fun to play for Electron users.



## Clashing Code

*I'm a reader of Disk User and A&B Computing and I use the utilities you have published to help me with entering BASIC programs. Auto-save regularly backs up my work while Checker makes sure listings are correct line by line.*

*I don't know if you are aware of it, but these and other utilities will not work together but the machine hangs up, BREAK being the only way out.*

*Is there no way the two can live together, as used in conjunction they would make life so simple.*

*Stephen Russell Kent*  
It's all to do with that scarce commodity, memory. There are traditional pages of memory, usually &A00 or &900 where programmers assemble their object code. There are alternatives as was explained in



**The Electron can run Disk User with 5" drives and a DFS chip. The Cumana system also offers a double density DFS option.**



the last couple of issues in John Kelk's Interceptors articles. On Disk User we supply the source code for any utility so that it can be reassembled at a location which does not clash with other temporarily resident utilities.

The P% variable is usually set up at the head of an assembler listing to the location at which the machine code will reside. By using P% and O% in conjunction, you can assemble to one memory area but with references for another, into which it can then be later loaded from disk (only on BASIC 2 onwards). We will endeavour to give this type of information when documenting our machine code utilities.

In this case you will wish to change the value of P% for the autosave utility away from &C00 where Checker takes up residence when \*RUN from disk. There is of course a ROM version of Checker available from Tony Rudkin, the author of the software. You can contact him at 102 Charmouth Road, St. Albans, Herts AL1 4SQ.

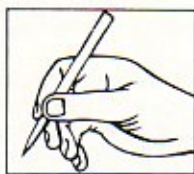

## Loony Tunes

We asked you to "Name that tune" in the last issue of Disk User and thanks for the many suggestions we received. We'll call you, as they say in show business. Not that we weren't impressed by your enthusiasm for the new tune. "I got a real surprise" said Mrs June Wright "when I started up the new issue, very good".

And your tune titles? Philip Richards said *Diskus*, Lee Visick suggested *Fidgety Didgets*, B.E. Chambers thought *Diskabel*. There were many more I could mention but the winner turned up the volume and the alliteration with six suggestions. We gave in and awarded the prize of 10 desirable Disk User data disks to K.Nixon of Bridlington. The chart rundown goes as follows: Bytes Bonanza, Bytes Boogie, Dance of the Disks, Disk Ditty, Disk Devils, Formatters Frenzy.

So Dance of the Disks it is when, if ever again, we make reference to our *current* theme tune. We may celebrate going monthly with a fanfare, you never know.

And Tom Fabling of Lenzie, why *Cheeky Rupert*?

Map : A Password : ARCTIC Code : 25363 Time Limit : 9000 File : ARCTIC

95 Bizaons. 1 Crown. 2 Eggs. 4 Keys. 17 Safes. 5 Time Capsules. 2 Spirits.

All sorts of repton screen maps can be printed with issue 5's utility.



## Map problems

*I initially had problems with the Repton map printer in your last issue. I discovered that residual data in memory, left behind by the !BOOT menu was upsetting the printout. By working from a cold start (mains switch!), on the BBC and the printer, everything worked fine. Many thanks for this program and Clive Dunkley's extra screens. Stan Parkes Gloucestershire*

We noted the Epson FX80 compatibility of the Repton map printer featured in last issue. Unfortunately the utility, although it seems to

work wonderfully with a whole variety of Repton screens from all the Superior packages, doesn't support some non Epson compatible printers. If you are experiencing problems then the suggestion above may help. Thanks Mr Parkes.

The problem of printer compatibility could put us off trying things like the Repton map printer but, because most printers will work, we think them worth running. Not even all Epson printers carry the same sets of capabilities. Often with graphic printouts use is made of reverse line feed when the printer mechanism actually back tracks and prints around or overlays earlier output. It's certainly a feature worth checking for if you are in the market for a dot matrix printer.

# CAREWARE – PSYCHEBROT

**Psychebrot – a psychedelic tour of the Mandelbrot Set and a new concept christened 'careware' for you to give a try out**

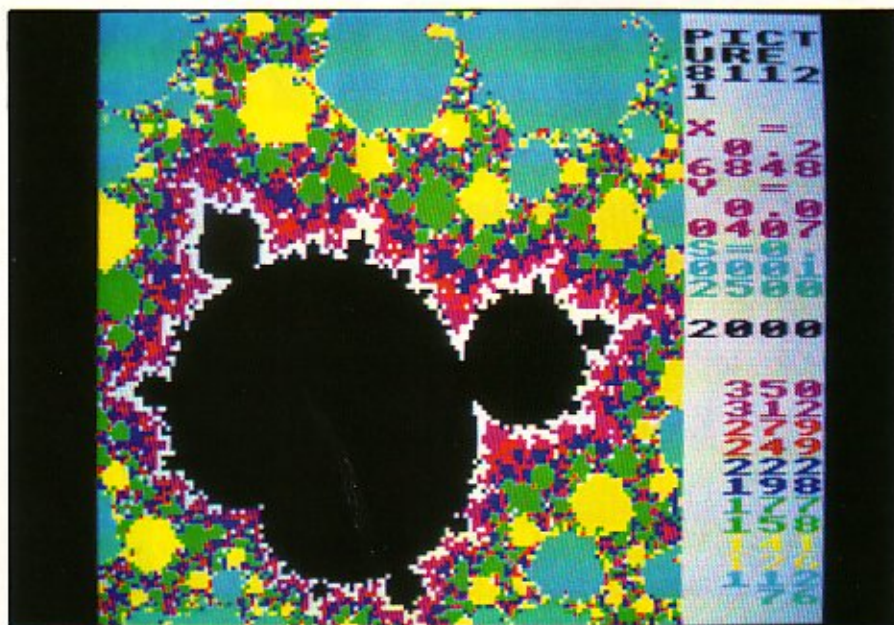

## Sampler

The *Psychebrot* program, a sample of which is included on the disk, was written by me about three years ago when I saw an article describing the basic calculation and decided to try it out on my BBC computer.

I designed a program to generate Mandelbrot pictures, and left it running on various BBC computers when they were idle, for instance overnight. As a result I built up a large collection of pictures, at least one of which represented about one week's continuous running!

Last year colleagues suggested that I prepared a live demonstration for the *Computer Images* exhibition at Brunel University. I created *Psychebrot* – by adding a new dimension of changing colours. The package ran for six weeks and created a lot of interest. I sold a few copies to

The Mandelbrot Set represents one of the most attractive fractal functions known and has generated enormous interest over the last few years. In principle the calculation is simple in that it involves calculating the series

$$Z' = 0 \cdot 0 + C Z'' = Z'' \cdot Z'' + C Z''' = Z''' \cdot Z''' + C \dots \text{until result } > 2 \text{ (or you give up)}$$

C is what mathematicians call a complex number. Complex numbers have two parts which are called X and Y on the pictures on the disk. Each picture represents a contour map with each pixel having a value that reflects the number of times the equation was evaluated before the result exceeded 2. Black areas in the basic picture represent pixels where the calculation was abandoned after a given maximum number was reached. Fortunately it is not necessary to understand the mathematics to appreciate the beauty of the resulting pictures.





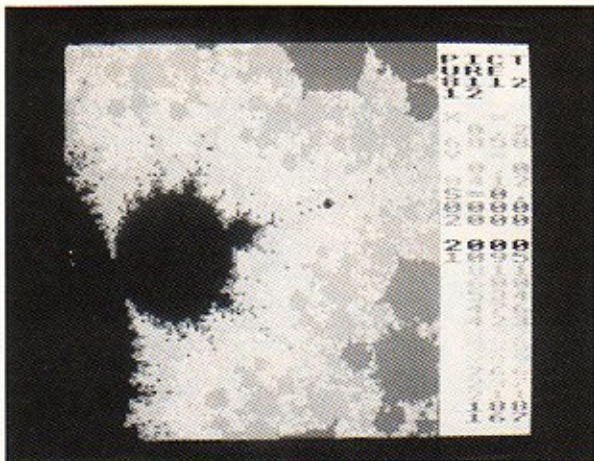

raise money for the mental health charity, MIND.

Many months later copies of some of the pictures were published in a popular computer magazine – and I was flooded with requests for copies. The package had been written as a means of relaxing during a time of stress during my daughter's mental breakdown and I had no wish to make a profit out of it. So I decided to give it away (at least at cost).

Each copy includes a request for a donation to be sent to MIND. People are also asked to pass copies to their friends, who will hopefully make a donation and give copies to their friends...

## Success

The result has been very successful. At the time of writing I have already provided over 150 copies, with requests from as far away as New Zealand. One copy went to a teacher on a training course – and copies were made for everyone else on the course...

Most people have sent their donations directly to MIND, but I have already forwarded enough to make the exercise worthwhile alone.

Many people have suggested that the idea of a charity "chain" software package is new, and this has attracted additional publicity. In particular Jaquetta Megarry has decided that this kind of software should be called "careware" – to indicate "shareware" that cares. This seems to be a very suitable name.

It seemed an excellent idea to let Disk User readers have a sight of the package, and to this end several improvements have been made. If you like what you see write in to the address at the end of the article.



The version of *Psychebrot* on Disk User cycles through the pictures automatically. The colour changes can be speeded up by pressing

<SPACE>. When the picture is still you may control the colour changes as follows:

**C** Change standard colour combination

**F** Flood with colour

**P** Psychedelic effect. This paints random bands of colour on a uniform background.

**W** Waves of colour cross the picture. This can make a "mini-mandelbrot" beat like a heart, and turn spirals into catherine wheels.

**X** Bands of colour built up by a kind of pincer action.

The complete *Psychebrot* package contains between about 20 (single sided DFS) and 130 (double sided ADFS) pictures and contains two extra commands.

**S** Shades the picture in such a way that many colour combinations give pastel shades.

**R** Generates a completely random combination of colours

In addition it is possible to control the order in which the pictures are displayed by:

<ESCAPE> Moves back to the master picture

**N** Moves on to the next picture

**G** Get picture by number

? Get "mystery" picture

**H** Hold current picture (for photography)

If the new picture is a close-up of part of the previous picture a window is drawn to show its location.

The full version also allows for the disk to be configured for continuous running under display conditions. Parameters are available to control the rate at which colours and pictures are changed, and the types of colouring commands used. The package also continues running, even if the <BREAK> key is pressed.

## The generator program (GEN)

The full *Psychebrot* disk now contains a simplified version of the generator program, GEN, so that you can create new pictures to be run with *Psychebrot*.

In order to understand how the package works it is important to realise that the generation process is slow. Even the simplest picture can take several hours, and some of the more interesting pictures from deep in the crevices can take many days! GEN initially creates a low resolution picture (so that you can check that you have given the right parameters, and then allows you to continue or abort at an early stage in the process. In addition it is completely restartable, using work files, so that you can interrupt the process at any stage for restarting later.

Once a picture has been completed you are given the option of saving it in a format suitable for *Psychebrot*. However you may decide that the distribution of the coloured bands is not to your liking – in which case you can allocate different parameters and rerun "at speed" to get a better picture.

As was stated earlier, the Mandelbrot set involved calculating the square of a complex number. GEN provides the facility to generate pictures using the cube function:

$$Z'' = Z * Z * Z + C$$

These are similar to those in the Mandelbrot set but have a subtly different character. It also allows the calculation of the so-called Julia sets – which can generate interesting pictures faster than from the Mandelbrot set.

## Availability

*Psychebrot* is available for the BBC Microcomputer and is supplied on 40 track DFS disks (19 or 40 pictures), 80 track DFS disks (28 or 59 pictures) and 80 track ADFS disks (about 130 pictures). (If you don't say which you will get 40 track DFS so be warned...) Copies may be obtained from:

CODIL Language Systems, 33 Buckingham Road, Tring, Herts, HP23 4HG.

A minimum charge of £2 is made to cover the cost of the disk, post, packing, etc. If you pay more the extra will be forwarded to MIND. Alternatively you may send your donation directly to MIND (mentioning *Psychebrot* so that they can assess the success of this appeal).

Overseas readers with no access to sterling should send an information leaflet on the local mental health charity that they intend to donate to, and they will be sent the disk free, by surface mail. (This avoids the penal bank charges for handling small sums of foreign money.)

*We at Disk User are sending off our cheques now. We think a good idea deserves success. How about you, readers?*

# BRIAN CLOUGH'S FOOTBALL FORTUNES

## FEATURES INCLUDE

- TEN STRONG LEAGUE • FA AND EUROPEAN CUPS
- 4 SKILL LEVELS • VARIABLE GAME LENGTH
- COMPUTER DIE • TELEPRINTER
- CONSTANTLY UPDATED LEAGUE TABLES AND ASSESSMENTS OF EACH MANAGERS PERFORMANCE

## CONTENTS INCLUDE

- COMPUTER PROGRAM • PLAYING BOARD
- 5 COLOURED COUNTERS • 112 PLAYER CARDS
- 6 IMMUNITY CARDS • PACK OF MONEY
- 10 SPARE PLAYER CARDS

Brian Clough's Football Fortunes, is a football management game with a big difference. In an exciting departure from earlier computer simulation games, Brian Clough's Football Fortunes combines an excellent range of computer based features with a fascinating board game. The result for the players is a package which gives the social aspects and skill of other best-selling board games with the flexibility and speed of play which only a computer can supply.

## SPECIAL OFFER!

Try out the demo now (using 'return' or 'space' to move around) and if you decide to buy Brian Clough's Football Fortunes, (£17.95 inc VAT + p&p), we will enclose a copy of 'Steve Davis Snooker' **FREE!** Please make all cheques payable to CDS Software Ltd, and quote Disk User when ordering!

"Even the most ardent anti-football person cannot help but enjoy it. Easy to use and beautifully designed."  
JULIAN RIGNALL ZZAP64 93%

"CDS has come up with a great game and presented it really well. It couldn't work as well purely as a board game, and it would lose something for being a micro-only game. The balance achieved is just right, making for a great family game."  
NIELS REYNOLDS. THE MICRO USER

Brian Clough's Football Fortunes can be played by two to five players who take on the roles of team managers. Each manager must successfully steer his team through the season, using his skill to make his team stronger as the game proceeds. He competes with human and computer controlled teams in a ten strong league, and the F.A. Cup. From the second season onwards, each team will also enter one of three European competitions.

# CDS Software LTD

CDS HOUSE, BECKETT ROAD,  
DONCASTER, DN2 4AD (0302) 21134

It's easy  
to complain about  
an advertisement.  
Once you know how.

One of the ways we keep a check on the advertising that appears in the press, on posters and in the cinema is by responding to consumers' complaints.

Any complaint sent to us is considered carefully and, if there's a case to answer, a full investigation is made.

If you think you've got good reason to complain about an advertisement, send off for a copy of our free leaflet.

It will tell you all you need to know to help us process your complaint as quickly as possible.

The Advertising Standards Authority.   
If an advertisement is wrong, we're here to put it right.

ASA Ltd, Dept 1 Brook House,  
Torrington Place, London WC1E 7HN

This space is donated in the interests of high standards of advertising.

## MICRO STUDIO

USE OUR READY MADE GRAPHICS  
AS A BASIS FOR YOUR ARTWORK

### STOP PRESS / PAGEMAKER USERS

#### PAGEMAKER GRAPHICS LIBRARY

150 Cutouts (Pack 1)	£14.95
Utilities Disc	£9.95
30 New Fonts	£7.95
Cutout Previewer	£9.95
Font Previewer	£9.95
FSE to AMX Converter	£9.95

### FLEET STREET EDITOR USERS

#### FLEET STREET GRAPHICS LIBRARY

200k (Disc 1)	£14.95
---------------	--------

### QUEST PAINT USERS

QUEST PAINT GRAPHICS LIBRARY	£14.95
------------------------------	--------

### GRAPHICS FOR THE BASIC BBC MICRO

VIDEPAK 150 screen pictureshow	£14.95
--------------------------------	--------

All prices include VAT and p&p. Europe add £3;  
outside Europe £5. State DFS format (40/80 SS/DS)  
Educational orders welcome

### £ £ £ SPECIAL OFFER £ £ £

Mention Disk User and claim 10% discount  
off any of the above titles

ARCHIMEDES A310	£845.00 incl.
(Trade-ins welcome)	

Dept 1, MICRO STUDIO, 83 CLAY STREET  
SOHAM, CAMBS. CB7 5HL. (0353) 721736



# GRAPHICS FROM BASIC

**Use this article with the Ellipse Tutorial on your disc and learn about graphics from BASIC. Refer to the disc every time you see the Disk User Logo next to a piece of text**

The first time I tried to write an ellipse drawing routine I failed dismally. That was because I didn't understand the use of the SINE and COSINE functions. Next time I worked out on paper how to draw a circle on the BBC Micro using the SIN and COS functions. Then it was easy to work out how to draw an ellipse which is basically a warped circle. I planned out the program and made it into an efficient routine.

To speed up the routine a look-up table of sine and cosine values has to be generated at the beginning, as calculating a Sin or Cos value takes the computer longer than looking up the values in a table.

## Circles

To draw a circle on a computer screen you must specify the centre coordinates of the circle, the radius and calculate the coordinates of each point through 360 degrees. Look at Figure 1. It shows the centre of the circle (X,Y), angle A, radius R, and a point on the circumference (X1,Y1). To calculate X1 you must multiply the radius by the cosine of the angle (A) and add the result to X eg

$$X1 = [R * \text{COS}(A)] + X$$

To calculate Y1 instead of using cosine you must use sine and then add Y eg

$$Y1 = [R * \text{SIN}(A)] + Y$$

For a complete circle you plot a line from each point to the next through 360 degrees.



Now we make use of our tutorial program. If you have not already run this program select the Tutorial option, the program now draws a circle of radius 400 on an axis X and Y. Just follow the on-screen instruc-

tion and you can't go wrong.

After pressing <SPACE> the program asks you to input a radius between 5 and 500. 5 is very small and 500 is the size of the screen. After doing this you can either have another go or go straight to the next screen.

## Ellipses

Look at Figure 2. It shows the centre of the ellipse (X,Y), angle A and a point on the circumference (X1,Y1).

Also given are the values MAJ and MIN.

MAJ is half of the width of the ellipse.

MIN is half of the height of the ellipse.

To calculate X1 you multiply the major length by the cosine of the angle (A) and add the result to X eg

$$X1 = [\text{MAJ} * \text{COS}(A)] + X$$

Calculating Y1 is done in the same way except that you must replace

MAJ, COS and X with MIN, SIN and Y respectively eg

$$Y1 = [\text{MIN} * \text{SIN}(A)] + Y$$

**NOTE:** the minor length may be smaller or larger than the major length and vice versa.



If you now go back to the program it will have drawn an ellipse on an axis. After pressing <SPACE> it asks you to input the minor length and the major length. As before these may be between 5 and 500.

## Ellipse at an angle

Angled ellipses are a lot more complicated than straight ellipses. Look at Figure 3. This diagram shows the centre of the ellipse (X,Y), the initial angle ANG (the angle of tilt), a point on the circumference

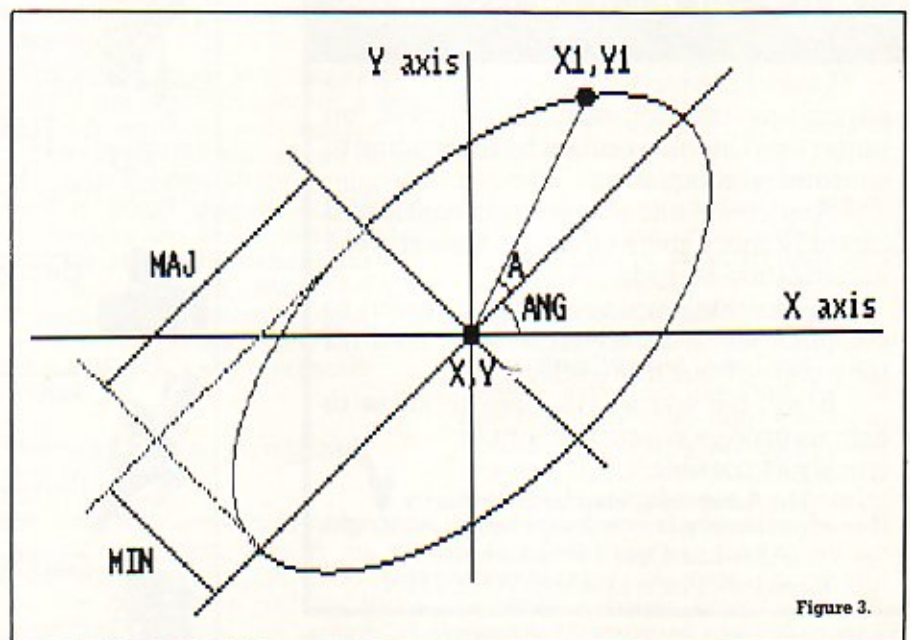

Figure 3.

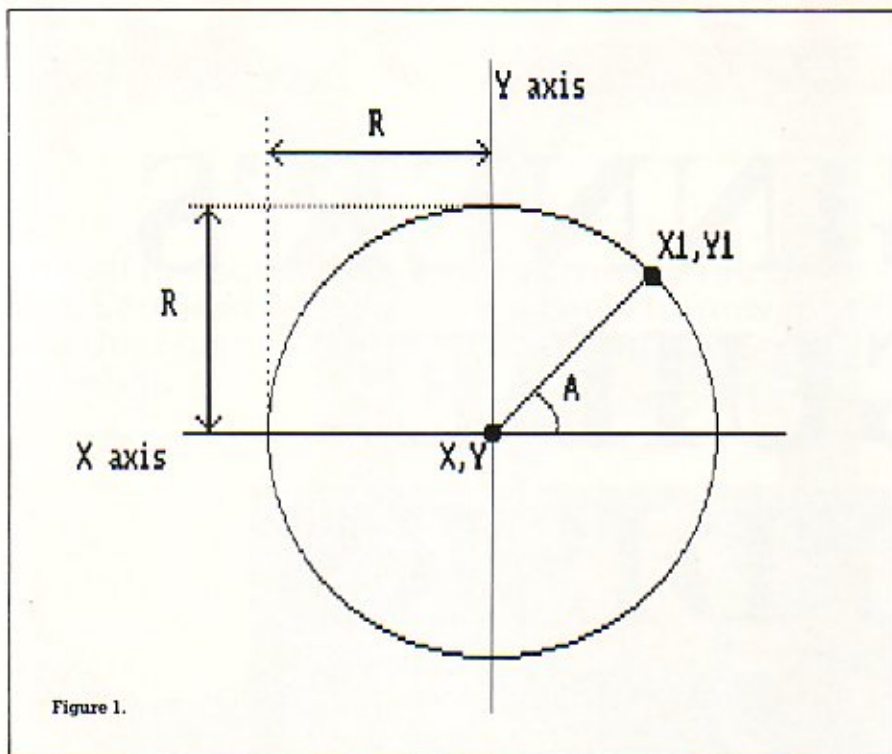

Figure 1.

(X1,Y1) and of course the MAJ and MIN lengths.

To calculate X1 you must multiply the major length by the cosine of angle (A) and multiply this by the cosine of the initial angle (ANG) minus the minor length multiplied by the sine of angle (A) multiplied by the sine of the initial angle (ANG) and add this to X eg

$$X1 = [(MAJ * \cos(A)) * \cos(ANG)] - [(MIN * \sin(A)) * \sin(ANG)] + X$$

As I said before this is a very complex algorithm and is difficult to understand.

Y1 is almost the same with only two changes so I will just show you the algorithm.

$$Y1 = [(MAJ * \cos(A)) * \sin(ANG)] - [(MIN * \sin(A)) * \cos(ANG)] + Y$$



The program has now drawn an ellipse at an angle on the axis. After pressing <SPACE> it asks for three parameters, MAJ, MIN and the initial angle, ANG. The initial angle can be between 0 and 360 degrees.(0 is horizontal and 90 is vertical).

### Circular arcs

Circular arcs are made in exactly the same way as normal circles except that instead of drawing from 0 through to 360 degrees you just draw from the start angle to the finishing angle. For example you

draw from 0 to 45 degrees to get an eighth of a circle. If you go through the 360th degree you must remember to start at 0 again. This has already been incorporated into the routine.



The program draws half a circle on the axis. It now asks for three parameters, the Radius R, the start

angle of the arc and the finishing angle of the arc.

**NOTE:** The routine always draws in a clockwise direction so if the finish angle is smaller than the start angle it will draw through the 360th degree.

### Elliptical arcs



The program draws an elliptical arc on the axis. These arcs are drawn in the same way as the circular arcs except you must give the major and minor lengths instead of the radius.

### Elliptical arcs at angles



The program draws the elliptical arc at an angle of 45 degrees on the axis.

The obvious difference between these and the elliptical arcs is that you must give the initial angle of the elliptical arc.

### Menu

The menu is there once you have worked through the tutorial program. Just type the number of the section you want to go to then press <RETURN>. To quit the tutorial and look through the program, there is a quit option in the menu.

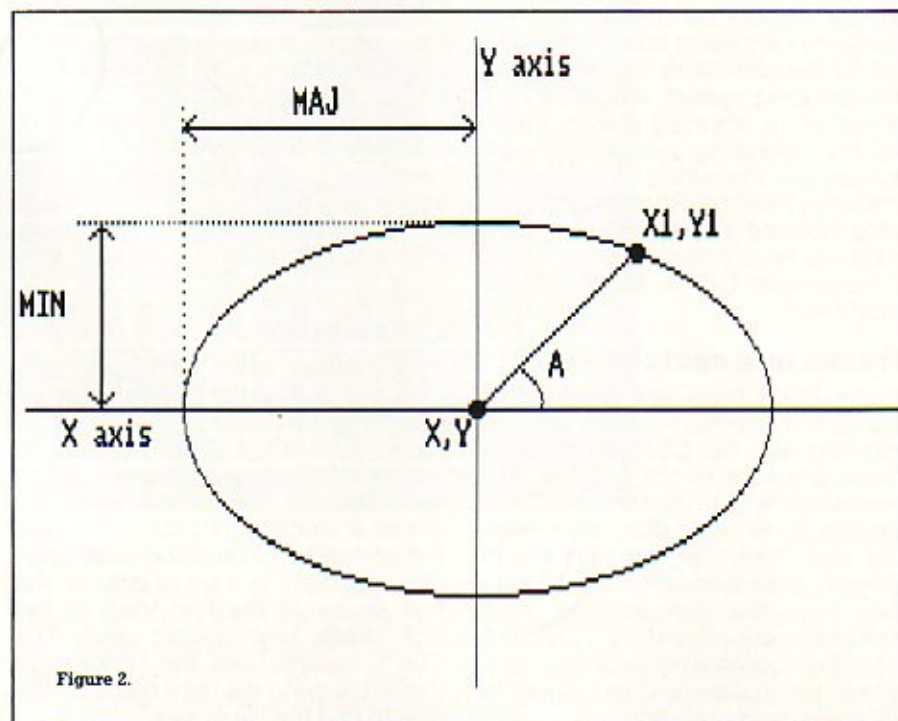

Figure 2.

# BEGINNER'S GUIDE TO DISKS

## A regular voyage into the world of disk drives and filing systems from the beginner's point of view

When the chevron prompt appears on your computer screen and you type, say, \*COPY 0 1 \*.\*;, it all seems so simple. But when you press RETURN, what happens? what actions does it prompt behind the scenes? What follows is in fact far from simple!

The first "\*" is recognised as a special symbol by the BASIC language you are using and it sends the rest of the command line through to the operating system, which doesn't in fact know anything about COPY. So the operating system, in turn, passes on the string to the other sideways ROM (or RAM) based software installed in the BBC. The DFS is usually next in line and, of course, it recognises COPY as one of its repertoire.

### Tracks and sectors

In the ROM there are a series of machine instructions which are associated with the COPY command. These are sent to the 6502 microprocessor, which then transmits instructions to the disk controller. The disk controller, processor and memory then work together to load data from the disk in drive zero (remember our command \*COPY 0 1 \*.\*). These components then combine to put that same data back onto the disk in disk drive one.

The filing system can find data on the disk because there is a set of "boxes" in which the data is held. The disk controller can go and find one of these boxes by a unique address.

When you type \*FORMAT (or similar) to format your disk, you are laying down 40 or 80 tracks, each of 10 sectors, onto the magnetic surface of the disk. Some disk filing systems/utilities have low level commands such as RECOVER <track> <sector> <memory location> <number of sectors>. This command reads from the specified track/sector address for a certain number of sectors and deposits the resulting data into consecutive memory locations.

### Catalogue

A command like COPY automatically supplies all the track and sector parameters for you.

Because it's a COPY command the machine code routine must find the particular files which you have asked it to copy. To do this it tells the controller to read the *catalogue*. The catalogue is a set of data on the first sector of the first track of the disk (track zero, sector zero). The COPY routine uses the information therein to go to the right place on the disk to find the file or files.

In this case (\*COPY 0 1 \*.\*), the wildcards \*.\* tell the routine to get all the files on the disk in drive zero and to transfer them to the disk in drive one.

The controller goes blindly off to the necessary locations (track and sector address) and reads the data.

The same information is used by the filing system to help it carry out all its commands. \*INFO for instance displays information about where a file is on the disk and how long it is.

Once the controller knows where a file starts and how long it is then it can also display where it ends and where any free space might be left on the disk (for \*COMPACT).

```
DFS 2.24
ACCESS      <afsp> (L)
BACKUP      <source> <dest.>
COMPACT     (<drive>)
COPY        <source> <dest.> <afsp>
DESTROY     <afsp>
DIR         (<dir>)
DRIVE       <drive> (40)(80)
ENABLE
FORM        40/80 (<drive>)...
FREE       (<drive>)
LIB        (<dir>)
MAP        (<drive>)
RENAME     <old fsp> <new fsp>
TITLE     <title>
VERIFY    (<drive>)...
WIPE      <afsp>
```

**The Disk Filing System, a collection of machine code routines**



# BLOBBER

Turn all the squares to strawberries in the time limit. Looks easy? You should know by now that Disk User games are never anything but a real challenge

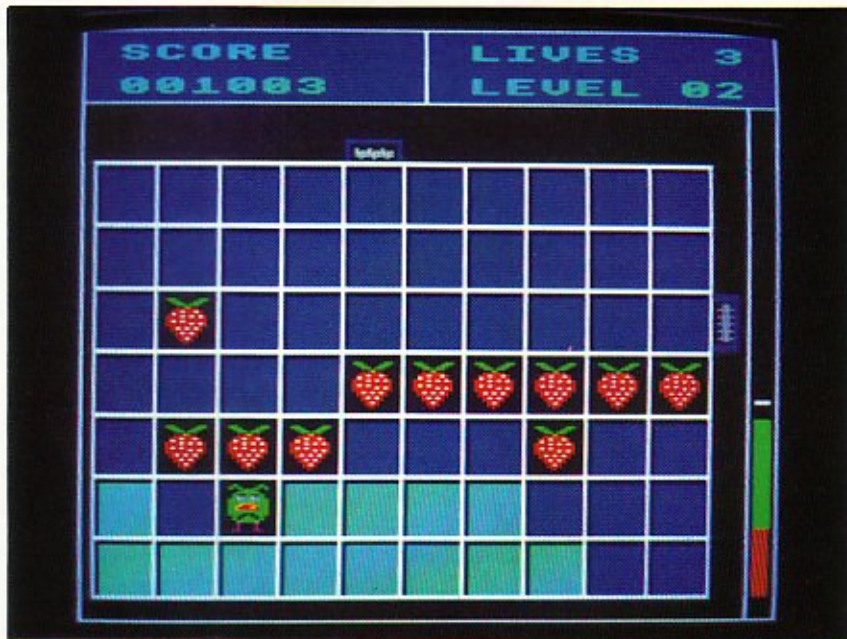
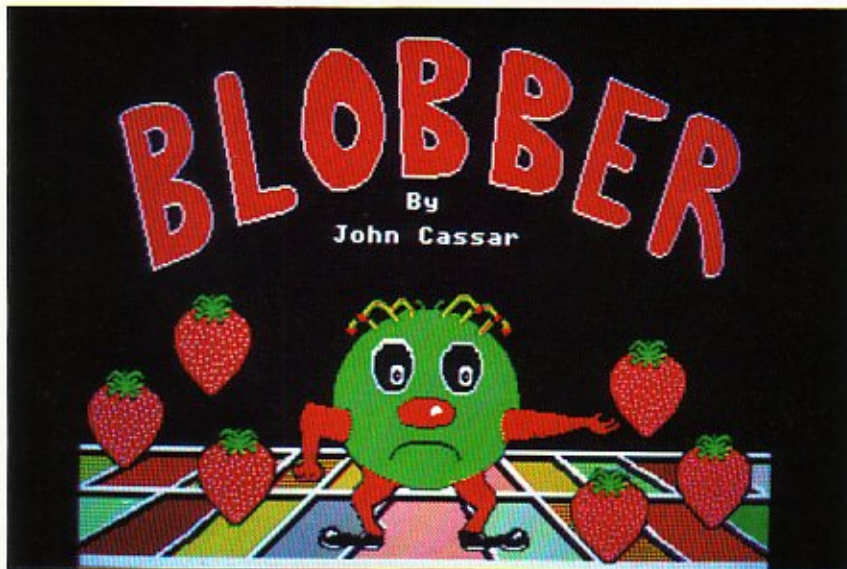

The object of the game is to turn all the coloured squares into strawberries in the time limit given, by moving *Blobber* over the squares.

If you take *Blobber* over a strawberry, it will change it back into a square of the initial colour. In each level an extra colour is added to the

sequence before the squares turn into strawberries. If the player tries to go off the board, *Blobber* will be placed on another square at random.

### Levels of play

Levels 1 to 6 are the easy levels because the *Electroids* that moves on the top and sides of the board do not fire and therefore all you have to do is change the squares into strawberries in the given time limit. The time limit depends on the level being played.



In levels 7 to 12 the *Electroid* at the top of the board starts sending an electric spark down the columns. If you are caught in the same column as the spark, you lose a life.

Levels 13 to 18 are the same as above but the *Electroid* at the side sends an electric spark sideways as well. Still think it's easy?

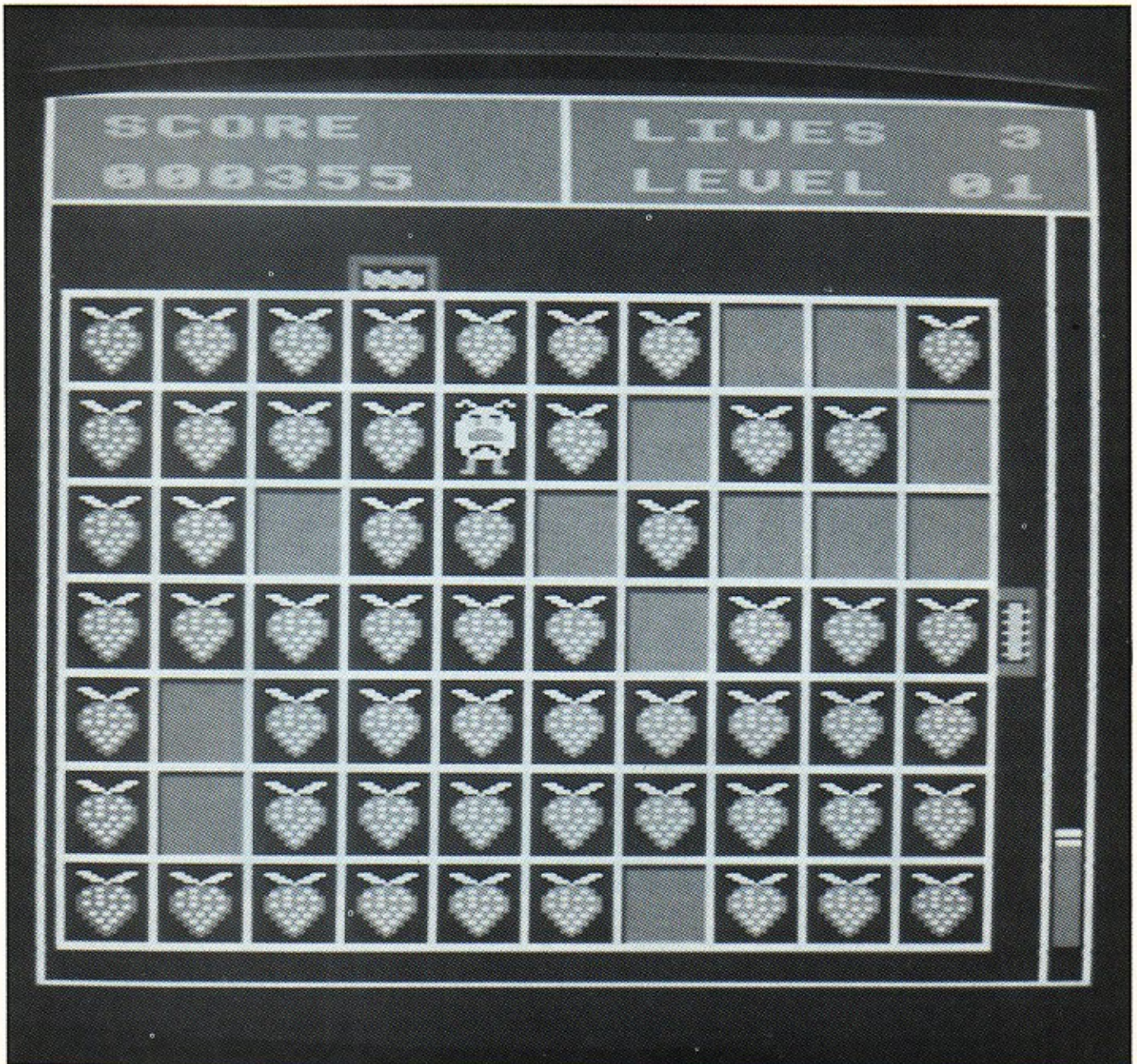

# MARTIAN NIM

The little known version of this famous game. Here's our guide to playing Martian Nim

The game can be played by one or two people. The solo player can play the computer and set the difficulty level for it. The computer can even play against itself.

Each player takes turns to remove some of the Martians from one of three rows. This continues until the last Martian is removed. The player who removes the least alien wins the game. To remove the aliens you enter the row A, B or C and the number of Martians. Try beating the computer on level 1. It is not easy!

Martians excel at this game, how about you?



Martian Nim features some very entertaining sprite characters

The *Pixel Perfect* package is made up of three programs written in BASIC and called PIXEL1, PIXEL2, and PIXEL3.

## PIXEL 1

This program creates a machine code routine at &900. Its function is to magnify a predefined area of the screen by reading pixels and then poking them a number of times into a different area of the screen thus creating a magnified image.

In Mode 2 each screen byte codes for two pixels. The colours concerned are distinguished by reading alternate bits.

For instance the byte value &2C carries the values for cyan and green.

00101100 (2C hex)

0110 cyan

0010 green

The cyan pixel would appear to the left of the green pixel on the screen if &2C were poked to screen memory.

## Magnification

The basis behind the magnification is shown in Figure one. Figure two consists of the codes for a magnified block poked to the screen. &00 gives two black pixels providing a boundary between the two colours.

# PIXEL PERFECT

Pixel level editing for colour screens



## MENU PAGE TWO. OPTION FIVE

A block such as that in Figure two is plotted for each byte read from the screen.

*Startpeek* and *Startpeek+1* contain the two byte value of the screen location in the top left of the area to be magnified.

*Startpoke* and *Startpoke+1* contain the two byte value of the screen location in the top left of the area in which the magnified area is displayed.

Finally *PIXEL1* sets *PAGE* to *&1200* to provide the extra memory required to run *PIXEL3*.

### PIXEL 2

This creates a machine code program at *&A00* and may be of use as a utility in itself.

A Mode 2 screen is organised in columns eight bytes deep arranged in rows 80 columns wide.

When calling the machine code created by *PIXEL2*, *A%* equals the number of bytes per line. A full line contains 640 bytes (8(bytes per column)\*80(number of columns)). This parameter effectively defines the width of the area to be moved. *X%* equals the number of rows. A full Mode 2 screen is 32 rows deep. This parameter defines the depth of the area to be moved.

Memory locations *&80* and *&81* point to the area to be saved. *&82* and *&83* point to the datastore. *&84* and *&85* point to the area to be filled. Each pair of pointers contain two byte values corresponding to the relevant sections of memory as follows. For example, the command

```
X%=16:A%=160:!&80=&3000:
!&82=&1D00:!&84=&31E0:
CALL&A00
```

will store a block one eighth the size of the screen from the top left hand corner in memory at *&1D00* and copy the data stored there to a block of equivalent size in the top right hand corner of the screen.

This routine is used in the program *PIXEL3* to store the sections of the screen overwritten by the editor window and to store the section of the screen currently being edited to facilitate an undo feature.

Finally *PIXEL2* prompts for the filename of the Mode 2 screen to be edited which it saves at *&A90* for use by *PIXEL3*.

### PIXEL 3

This is the main program from which the two machine code utilities are called. The use of machine code is partly to increase the speed of what would otherwise be somewhat slow processes and to save memory above *PAGE* for the BASIC program.

There are essentially three sections within the program.

**1. The screen area selector.** Here a cursor is moved about the screen and the area required for editing selected. As the cursor is moved the editor window is continuously updated. The area of screen obscured by the editor window may be edited by moving the cursor in that direction. Before the editor window is reached it will be moved to the opposite side of the screen and the area of the screen beneath it is revealed.

The keys are:

```
Z LEFT
X RIGHT
/ DOWN
: UP
] SELECT
```

**2. The editor.** Once an area has been selected you gain control over a cursor within the editor window which is displaying the selected area of the screen in a magnified format. The cursor is moved using the same keys as above only the select key in this case will change the pixel indicated by the cursor to the colour indicated by the border of the editor window.

This colour can be altered by pressing the appropriate number key (ie 1=red 2=green etc). Should you be unhappy with the changes you have made since you entered the editor, pressing "U" will reverse all the changes. To exit the editor press TAB this will return you to the screen area selector. If you escape by pressing SHIFT and TAB together you enter the options menu.

**3. The options menu.** The menu offers four choices:

**a LOAD** enables you to load in a new screen. The filename under which the previous screen was loaded is displayed and if RETURN

alone is pressed this filename is used.

**b SAVE** enables you to save the screen currently being edited. Again the previous load filename is displayed and can be selected by pressing just RETURN.

**c EXIT** takes you into the screen area selector.

**d QUIT** exits the program.

### Procedures

For those interested in altering *PIXEL3*, here is a list of procedures, functions and variables used.

**PROCSCREEN** reading keys for screen area selector.

**PROCWINDOW** reading keys for editor.

**PROCLEFT** switch editor window to left hand side.

**PROCRIGHT** switch editor window to right hand side.

**FNMOVE1** draw screen cursor and update editor window.

**FNMOVE2** draw editor cursor.

**FNBORDER** draw the editor window border. Note the use of graphics windows and CLG.

**FNCOL** change colour of pixel selected.

**FNUNDO** removes changes.

**FNSETVAR** initialise variables both on startup and following a trapped disk error.

**FNSAVE** save the screen.

**FNLOAD** load screen.

**S%** start of memory store for UNDO routine data.

**M%** start or memory store for saving screen overwritten by the editor window. **T%** toggle for window position if

**T%=0** window on left if **T%=1** window on right.

**K%** current defined colour.

Figure One - carrying out magnification

```

                                00101100
                                AND#170  AND#85
                                00101000  00000100
                                cyan/black  black/green
shift bits right                    shift bits left
                                00010100  00001000
                                black/cyan  green/black
                                addition    addition
                                00111100=&3C  00001100=&0C
                                cyan/cyan    green/green
```

Figure Two - magnified block poked

```

&3C &3C &3C &00 &0C &0C &0C &00
&3C &3C &3C &00 &0C &0C &0C &00
&3C &3C &3C &00 &0C &0C &0C &00
&3C &3C &3C &00 &0C &0C &0C &00
&3C &3C &3C &00 &0C &0C &0C &00
&3C &3C &3C &00 &0C &0C &0C &00
&3C &3C &3C &00 &0C &0C &0C &00
&00 &00 &00 &00 &00 &00 &00 &00
```

# MAGIC WALL SOLUTION

Last issue, the magic wall puzzle program had you all pulling your hair out. We now alleviate the suffering with the solution . . .

Firstly this solution has been written with the assumption that you, the reader, are sat with MAGIC WALL up and running on a computer in front of you. If you haven't then it might be an idea to make it so! If this involves getting a back issue of Disk User 5 then by all means turn to SERVICES in this issue to order one.

A form of shorthand will be used throughout this solution as follows:

#### Colours

There are six ROWS of colour, which will be known by the lead letter of their colour, namely (from top to bottom)

C=Cyan M=Magenta B=blue

Y=Yellow G=Green R=Red

#### Columns

There are six vertical positions or COLUMNS which are simply the pointer positions and are labelled 1 to 6 from left to right.

For example **R to 4B** means move Red colour to the Blue Row in Column 4. It should be noted at this point that in order to do this the pointers should be moved to Column 4 if they are not already there.

#### The solution

R to 1G M to 3C In one move - R to 1R and M to 1M G to 2Y B to 4M In one move - G to 2G and B to 2B Y to 4Y

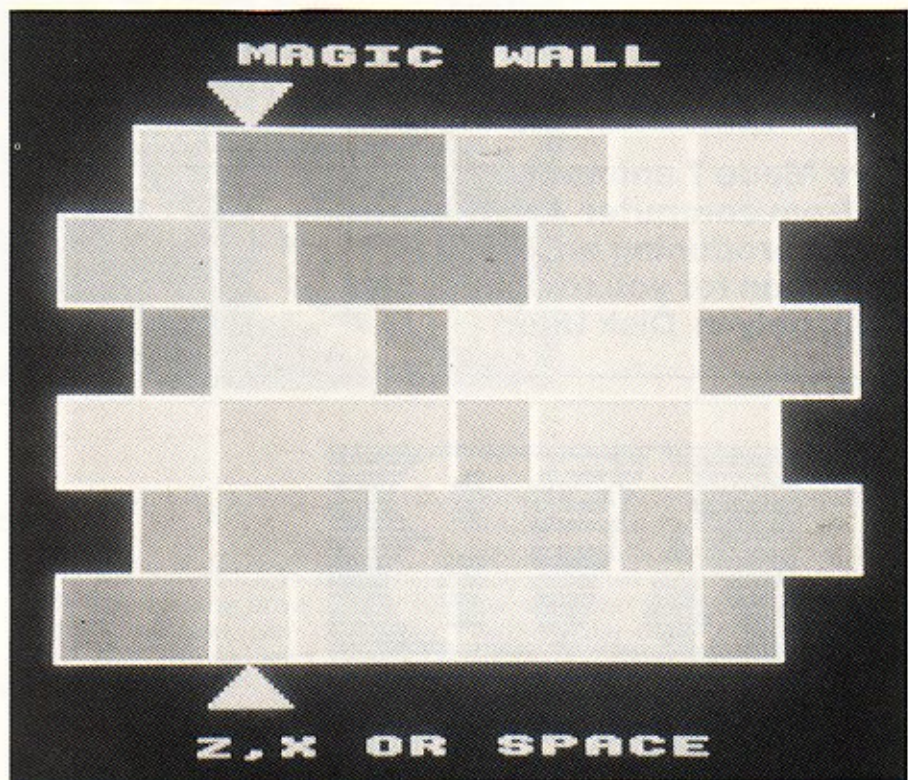

In the sequence that follows Column 3 will be sorted by a sequence of single shifts and insertions at 3G. If during this routine you find that the required colour is not available in Column 5 then insert *any* colour and go on to the next move. You will find that the required colour is then readily available at the end of the routine.

Y to 5G and the same Yellow to 3R B to 5G and the same Blue to 3R M to 5G and the same Magenta to 3R C to 5G and the same Cyan to 3R R to 5R and the same Red to 3R G to 5G If you find at this point that the colour sequence is wrong in Column 3 simply move the offending colour to 3G and replace it with the correct colour from Column 5 into 5G. Don't forget to return Column 3 to its original position on completion (R to 3R).

At this point Columns 1 to 3 should now be sorted. Next . . .

C to 6G G to 5B In one move - G to 6G and C to 6C

At this point the only unsorted column should be Column 5.

G to 5G Look at Column 5. Starting at the Green look *up* the Column until you find the first brick that is the wrong colour. This brick is of the *offending* colour. The row, that this brick is in, is of the *correct* colour.

1. *offending* colour to 5G 2. *correct* colour to 3G 3. There should now be two bricks of the same colour in Column 5 (the brick at 5G and one other). Move the other brick of the *correct* colour to 5G. 4. R to 3R 5. G to 5G

Repeat steps 1 to 5 until MAGIC WALL is completed. **CHEAT!**



# TRANSFER

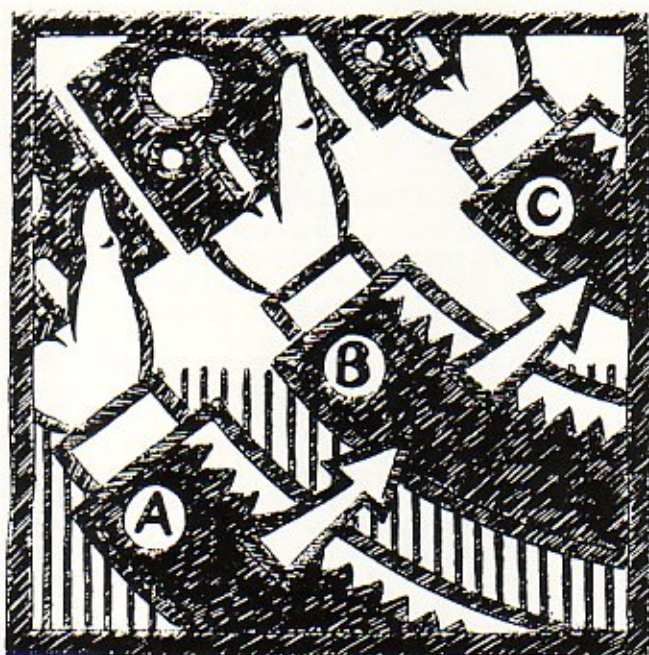

## Taking your disk files one step further

*Disk User* programs can be so useful that you'll often want to transfer them to their own disks and use them separately, without title page or menu. To do this successfully you'll need to learn a little about BBC BASIC and the DFS (Disk Filing System). In *Disk User* we don't believe in referring you to the manuals to here's an explanation of how such a transfer can be achieved.

Let's take the SCALER program as an example this month. The relevant file on *Disk User* is:

### SCALER

Make sure you have a blank data disk ready to receive the file. Insert *Disk User* and type

#### \*COPY 00 SCALER

and press the RETURN key. Follow the keypress prompts on the screen until the > prompt returns.

On completion place your new disk in the drive. Type

#### \*BUILD !BOOT

upon which the disk drive will whirl and a number will appear on screen. Type

#### \*SCALER

and press the RETURN key. Wait for a second number to appear and then press the ESCAPE key. Let the

drive finish any activity and then type

#### \*OPT 4,3

and press the RETURN key. Once again wait for any drive activity to cease. Now you can press the SHIFT and BREAK keys together, releasing the BREAK key first, then the SHIFT key. This will boot your new disk into action, automatically executing the command \*SCALER. The program loads and runs and asks you whether you want enlarge or reduce. For now, press the CTRL and BREAK keys together.

## Give it a title

You can now type

#### \*TITLE SCALER

and press the RETURN key. Now type

#### \*CAT

and press the RETURN key and the screen will display the title SCALER with the files !BOOT and SCALER lined up below. You may now use this as your *graphics utility* disk, saving other utility files (such as the screen compression program in the last issue) in the space available (space is something we don't leave on *Disk User* itself).

The process described above can

be repeated for any of the files which are detailed at the end of *Disk Instructions* each issue. A useful new disk you could create would contain the software database from issue two, another could be a complete utilities disk with this month's split screen and instant OS command, our disk recover utilities from issue two and disk examiner from issue one, all handy and on a single disk ready to use. You can even modify our simple menu program to provide an easy way to access the programs.

## Disk User menu – how to use it

If you have been reading *Disk User* from issue one you will have noticed the MENU file which appears on each disk. This program has been re-written several times to make it easier to select software from and to use on your own disks. The front end of the menu is clear and colourful. This means that the programs provided on the disk are easily accessed.

To use the menu with your own disk the following tips will be of some help. Firstly the most important thing to note is the way the information about the files on the





# SCHIZO SCREENIA

**The simultaneous screen split utility which lets you switch between two active on-screen windows with consummate ease**

Here is a program that is well worth a few sectors on your utilities disc. During program development or housekeeping sessions, it is often useful to be able to keep track of two things at once; for example, the catalogues for two disc drives, or listings for different sections of a program.

Using the BBC Micro's window feature, this utility enables you to switch between the two sections with ease.

Once *SPLIT* has been called, the screen will be split (vertically) down the middle into two equal areas until you press <BREAK> or cancel the procedure by calling *SPLIT* again.

Thus the screen will always comprise two windows whichever Mode is selected. A 80 column screen Mode is recommended.



We have provided the source file S.SPLIT for you to work with. Running the program will save a machine code routine called *SPLIT* - it is this program which presides over the window-swapping and will remain active in the machine until it is cancelled or accidentally overwritten.

To use the utility once it is held in the current library on disc, simply type:

**\*SPLIT**

and the routine will be activated (or deactivated if it was previously active).

Thus \*SPLIT toggles between split and un-split modes of operation.

Once the screen is split the <TAB> key will switch the cursor between the two windows, always returning it to the last-used position in that window. If you change screen Mode while split, the screen will stay split as the routine detects Mode changes as soon as a key is pressed.

The program works by intercepting the OSRDCH vector. OSRDCH is the Operating System Read Character routine (hence OSRDCH) and is a piece of code that is entered each time you press a key. By intercepting this vector we get the chance to study the character entered first, before passing it on to the proper piece of code for the usual processing.

*SPLIT* checks to see if the current screen Mode is the same as the last one stored (if not we are out of date and need to catch up by redefining our windows) and if so, to see whether it is the <TAB> key that has been pressed. If the key is not <TAB>, then it is no business of ours and we exit from *SPLIT*, having tidied everything up before we go.

When <TAB> is detected, then we remember the cursor position in *this* window, switch windows and restore the cursor to its *old* position, when it was last in *that* window. This completes the switch and the user is (almost) able to carry on with that window's task as though he had never been away. (An exception is where <TAB> is pressed halfway through a word. Pressing <TAB> again will appear to return you to the middle of that word, although the computer has by this time 'forgotten' what the word was and will need reminding - ie re-type it!)

## Technical details

The *SPLIT* coding itself is less than a page (256 bytes) long and so can be hidden away in the machine quite easily. I have located it at &900 by setting the program variable Code to &900; you may wish to change this. The routine uses 9 zero page locations starting at Zero - Page and this may also be changed to suit your application. The processing follows the scheme outlined in the preceding paragraphs but the following notes should be of some interest.

The dimensions of the screen for each Mode are stored in the tables tab1 (for the width in characters) and tab2 (for the depth in lines) and these values determine the sizes of the windows. Iflag determines which window you are in - 0 for left, 255 for the right; pressing <TAB> toggles it between these values.

When the code is entered for the first time, it needs to store the old OSRDCH vector somewhere safe and replace it with an address within *SPLIT* called NEWRCH. So that a second call to *SPLIT* does not corrupt the stored vector, the program checks to see if the vector is pointing at an address below &8000, that is, outside the ROM area and if so it assumes that this address is its own. In this case, *SPLIT* will deactivate itself.

If you intend to use the *SPLIT* routine in a ROM or located in some strange place, this test will need to be amended and tightened up.

# ZOOM LENS

Enlarge or reduce any part of a screen picture  
with this sophisticated scaling utility

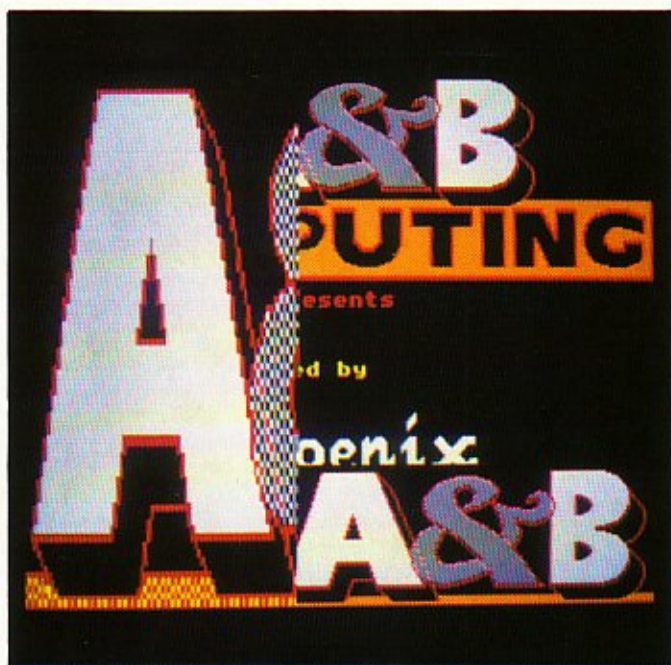

Move the box corners with the cursor keys.

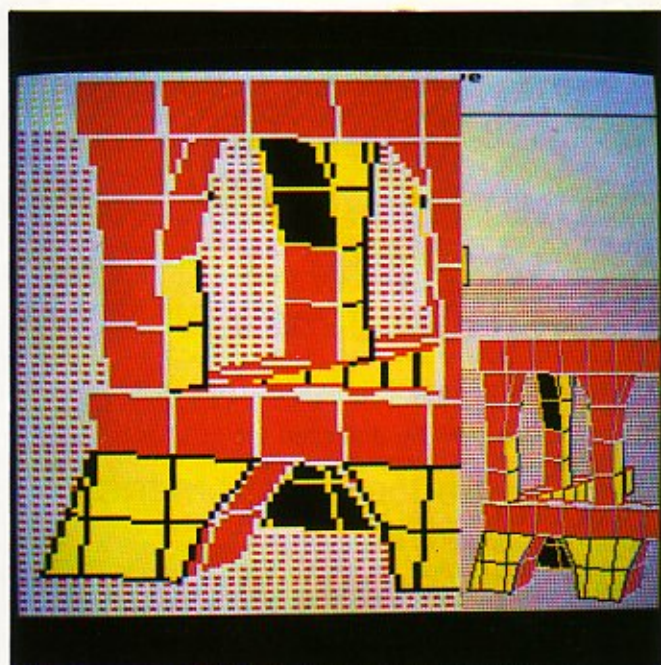

TAB swaps corners, COPY starts.

The machine code program SCALER on your free disk is a simple but powerful utility. The example screens show what you can do when it comes to enlarging well-known graphics screens but you can reduce screens too. This latter option is very useful if you wish to keep a library of high resolution screens on a limited number of disks, the screens can be reduced and resaved, only to be enlarged later. It's a method of compaction you may prefer over our compress utility be-

cause the reduced screens can still be displayed. If the screens are in the same Mode then they can be \*LOADed into a gallery in one screen.

Scaler can be accessed via the menu or simply by typing \*SCALER from the BASIC prompt. We have not included any particular example screens for you to experiment with although there are a number of compressed graphics screens on the disk.

A small program to resave a Mode 2 screen, for instance, might

go like this:

```
10 MODE 2
20 *PLD <filename>
30 *SAVE <newfilename> 3000 8000
40 *SCALER
```

Scaler will take over and prompt you for the screen filename you have just used. I'm sure readers will come up with all sorts of uses for this facility. Why not send in some *enlarged* versions of your favourite game screens or your own efforts with a paint program? In the meantime have fun with Scaler.

# FLOPPY FUN

Your letters to this column keep pleading for maps, hints, solutions and cheats for programs. We aim to please.

## It's magic!

Lots of people have written in with complete solutions for *Palace of Magic*. So far, we have been constrained in this column from publishing them due to the ongoing competition.

Now, however, all can be revealed. Thanks to Marcus Turner, Iain Hotchies, Jason Keble and Alexander McLean, here is the complete solution.

## The solution

Note that co-ordinates are given as they appear on screen - 'y' and 'r' are yellow and red respectively and keys are coded thus: m(agenta), (w)hite, (c)yan, (b)lue, (g)reen and (r)ed. So the starting point (The Main Palace) is y0:y0. All clear? Then off we go:

From start go up to Rooftop (y1:y2), collect m/w key, down to Passages (y0:r2) and open gate. Go left to r3:r1, collect rope, left again to r4:r1 and get c/b key.

Right and up to Main Palace (y0:y1), drop rope, east to East Palace (y1:y1), open gate, right and up to East Tower (y3:y2). Climb over central pillar to collect bricks, back to top of tower, jump left to Rooftop (y2:y2), collect w/g key, continue left and down to Main Palace (y0:y0), drop bricks and collect rope.

Left and down to Tower Base (r4:y0), open gate, right to West Palace (r3:y0), drop rope and get cross. Up to Rooftop (r3:y3) and collect statue.

Down and right through East Exit (y3:r1) and East Wood to Balcony (y8:r1). Priest will take cross as you enter. Go right and up to Church (y8:y0), collect halo, left and down to y9:r1, get y/r key and leave statue.

Back to Main Palace (r1:y0), drop halo, take g/w key and go down to West Palace (r2:y0). Open gate, go down, collect candle and return to Church (yA:r1). Down to Cellar (yA:r2), open gate, back up to Church (y9:y1) and get statue.

Down through Cellar to Dungeons (yA:r3), drop through gap immediately on your left, fall to right a little and then take passage to left. Drop



to Dungeon below (yA:r4), then down and left to yA:r7 and up and right to y7:r6. Drop statue (dragon heads vanish), return to yA:r7, collect bowl and return to Main Palace (r1:y0) carefully.

Drop candle, take halo, go left to West Palace (r3:y0), drop bowl, take rope and go left and up to Guardhouse (r4:y3). Up to West Tower (r4:y5), take r/y key, drop rope, back down and return to r1:y0.

Take candle, right and down to East Exit, drop r/y key, take b/c key, return to Church and down to y8:r7. Open gate, go left and down to Caves (y6:r8) - halfway down rope, turn left into hidden passages and get frog. Return to Castle.

Drop candle in West Palace (r3:y0), take bowl, go left and up West Tower to r4:y6, fill bowl with rainwater and jump to right to fall to the right of the tower to the Guardhouse. Right to r2:y3, down rope onto temple roof (r2:y2). Hop right to Rooftop (y0:y2), down and right to East Exit (y2:r1), drop frog and take r/y key.

Right to Church (y8:r1), open

gate, return for frog then go through Church, Forest and over Bridge to the Firepit (yH:r1). Put out the fire with the bowl of water and go right to Royal House (yI:r1) - princess disappears with frog so go right for w/m key.

Back to East Palace (y2:y0), down to Basement (y2:r2), open gate, left to y1:r2, up to Passages (y1:y1), get gold, then go right, up and left to Main Palace (y0:y1).

Get bricks, down and left through Passages to West Exit (r4:r1) and drop bricks to reveal hidden exit. Left into West Wood and exchange gold with Repton for magic sword.

This has limited life (watch number top right count down to zero), so quickly go to East Palace (y1:y1) killing snakes with the sword, then left to y2:y1 and get magic boots.

Right to Royal House (yJ:r1) and get treasure chest. Then left to West Wood (r6:r1) and give chest to guard. Then left to transporter, drop boots to activate the teleportation system and return to your normal size.

Phew! Still a struggle, isn't it?

# PAINTING THE TOWN

The BBC Microcomputer owner is blessed with a staggering range of hardware devices and software packages for creating graphics. We've included some results on this month's disk and here's a roundup of what you might expect to find in your local Acorn dealer

## Case study 1

BBC graphics tools are often used to help people make a living. *Urban-craft Design Ltd* is a Sunderland based company which uses equipment such as Watford digitiser, Glentops Interactive 3D, 3D Zicon and Plotmate plotter. Urban-craft uses its BBCs, Model B and Masters, to produce underlays for product and interior design illustration.

## Case study 2

Quality computer graphics are now accessible to home computer users via budget priced software. Our own Colour Ikon package has been used successfully by our readers and we have included an example on our disk this month. Colour Ikon uses disk overlays to provide an easy to use colour graphics art program for Model B only for £8.00.

## Software

Other sophisticated disk-based software is available for use with a mouse, such as Artroom and Ace from Clares and Illustrator from Nidd Valley. Artroom is black and white for Master Series only with Ace for adding colour.

Still more sophisticated graphics software requires the installation of ROM software. The Artist was the first of a generation of ROM based packages, now superceded by the excellent Quest Mouse from Watford Electronics which utilises pop up menus to allow drawing on the whole screen area. Microbrush is a more expensive but more comprehensive set of software, more suited to professional work where it can be made to pay its way.

## Input devices

Mice, joysticks, graphics tablets and trackballs can be used with many of these programs. AMS, Nidd Valley and Wigmore House produce mice to support their software products, the AMS mouse being the best known. The driver software is often utilised in other packages (such as Comms) to get feedback from a mouse and Acorn's Archimedes mouse commands will be very familiar to AMS mouse users.

Graphpad 2 is an excellent digitising tablet supported by its own software and educational packages such as Cambridge Micro Software's Image. The Marconi trackball is another standard. Also used as part of the Domesday hardware, the trackball is very suited to CAD style programs. Many programs also offer joystick control, especially as an alternative to a mouse. One of the best known companies is Voltmace who have a wide range.



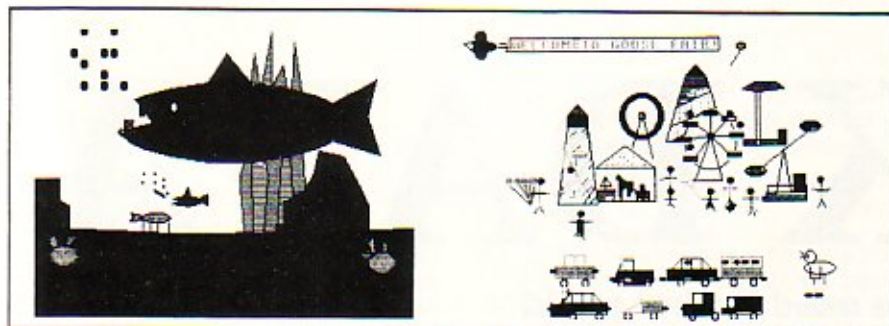

Iron art from Rebecca Jane Sands - when drawn aged only eight.

Watford's digitiser is the most accessible interface for the BBC. You'll need a camera too but can probably make do with a cheap security camera rather than a Camcorder or similar. Linear Graphics' Plotmate plotter can "scan" images with the addition of an optical sensor.

### Clip artists

Some packages, such as Fleet Street Editor and Artrroom, provide graphics libraries. Fleet Street is especially well supported in this respect.

Micro Studio have shown great ingenuity in producing a large range of clip art for AMS's Stop Press package and a set of digitised pictures for general use. They also provide a digitising service for specific art projects on the BBC Micro.

There are 20 categories of clip art

in all, the latest being history, logos, places, geography, fashion, cartoon, birds, nature, buildings, reptiles and rock 'n' roll. Each disk has 30 cutouts. The minimum order is for five disks, each costing £2.00 per 80 track disk single sided and 40 track double sided. Two single sided 40 track disks cost £3.00.

Micro Studio also sell digitised pictures, one of which is featured on this month's disk. It's from the Videpak three disk set which contains over 150 compressed pictures on three double-sided 80 track disks, price £10.00.

### Output devices

The first output device to consider is the monitor. Televisions do not do justice to BBC graphics. A medium resolution colour monitor will suffice.

Dot matrix printers are the most popular option for redisplaying the screen image on paper for distribution. Colour is increasingly gaining a foothold, especially in education, so if you are investing in a printer now, the Integrex (Canon ink jet mechanism) is worth considering. It has the software support you will need to dump pictures from your software.

If money is no object then the new Epson laser printer, the GQ3500 is excellent value and a company called Datathorn are giving it their full support with printer drivers, forms design program and downloadable fonts for the BBC Micro.

### Disk Data

Micro Studio ☎ 0353 721736.  
 Linear Graphics ☎ 0702 541663  
 Integrex ☎ 0283 215432  
 Clares ☎ 0606 48511  
 Cambridge Micro Software ☎ 0223 312393  
 AMS ☎ 0925 413501  
 Nidd Valley ☎ 0937 844661  
 Wigmore House ☎ 01 734 0173  
 Marconi ☎ 0522 29992  
 Voltmace ☎ 0462 894410  
 Datathorn ☎ 01 508 4904

## COMPETITION...COMPETITION...COMPETITION ...COMPETITION...COMPETITION...

**FLEET STREET**  
 Editor  
**WALT DISNEY GRAPHICS LIBRARY**  
 Graphics by Mr Micro  
**MIRRORSOFT**  
 80-TRACK BBC DISK

### Stop Press (Pagemaker) users

**WIN Extra Extra, the fonts and graphics library for Stop Press.**

All you have to do is send us a printout of your favourite creation on Stop Press. The best effort in the opinion of the Disk User judges will win the fabulous Extra Extra from AMS.

**EXTRA EXTRA**  
**AMX PAGEMAKER UTILITIES**  
 WORKS WITH KEYBOARD, JOYSTICK & AMX MOUSE

### Fleet Street Editor users

**WIN Fonts 'n' Graphics, Disney Graphics and Admin Xtra for your Fleet Street setup.**

All you have to do is use your Fleet Street Editor to create an interesting A4 desktop published page. The Disk User judges will pick their favourite and send you all three add-on software packs for the famous Fleet Street Editor from Mirrorsoft.

All entrants, send your entries together with name and address details to us at Paint the Town, Disk User, Number One Golden Square, London W1R 3AB.

# DISK DATA

**BBC disk based files can be used farther afield than you might expect. Beebdos provides BBC micro file compatibility for the IBM PC standard**

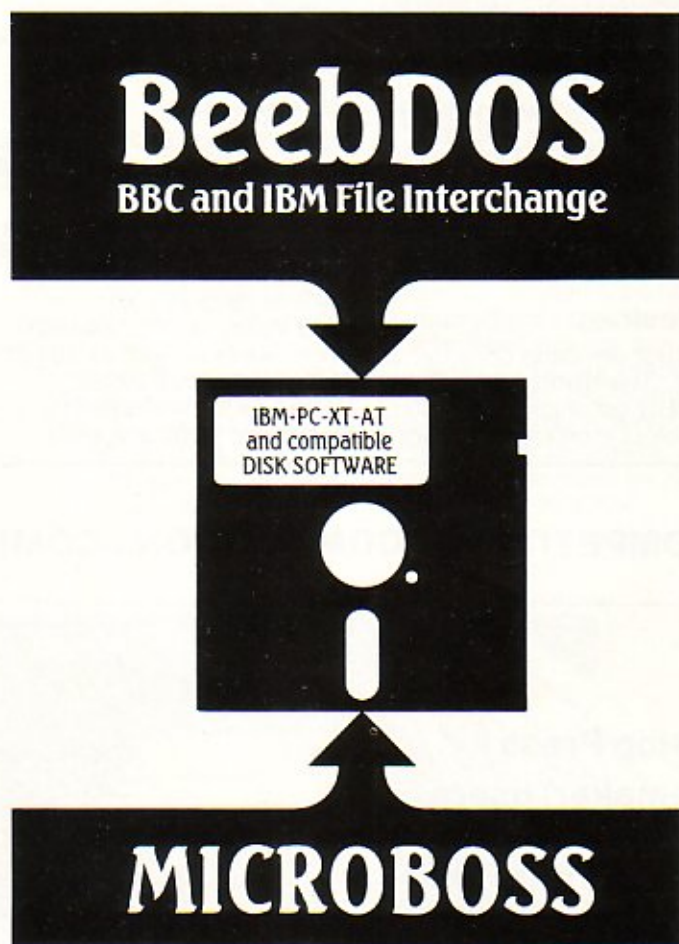

*Beebdos* from *Microboss* is a set of utilities for IBM compatible micros which emulate a variety of different BBC Microcomputer filing systems. It is **not** for the BBC Micro specifically, but for people with **both** machines.

There are three possible markets at which this product is aimed. Firstly the business person who has IBM compatibles at work and a BBC Micro at home and who wishes to transfer files from eg a wordprocessor so they can be worked on at home. Second the educational user who has a number of machines of both kinds on one site, and requires file compatibility both ways, for both learning, and administrative purposes. Lastly the programmer who

wishes to port code across from one computer to the other. In any case the user needs some technical knowledge.

### Packaging

Beebdos comes as a 360K IBM format disk together with a 35 page desktop-published manual, and an update sheet for version 2.00 packed into a slim wallet. The manual is well written, but rather terse on some topics, and without an index, although there is a useful summary of the commands on the back cover.

### System requirements

To run Beebdos you must have an IBM PC/XT or AT compatible with at

least one floppy disk. For technical reasons most users who have 360K drives will only be able to communicate with a BBC machine that has a 40 track disk drive, and a non-standard double density filing system, or ADFS. To select your filing system a utility, BDOS is supplied.

### On the disk

The utilities themselves come in the form of EXE (EXEcutable program) files, and to use one you must type in its name followed by the correct syntax, eg:

**BCOPY a:\*. \*;:1.\* \***

to copy files from an IBM disk to a BBC disk. The heart of the system are the three programs BCOPY, BCONV, and BGRAPH.

BCOPY controls transfer of files, between the two disk formats in both directions.

BCONV changes files that have been copied over into a more suitable format for use in the PC environment.

BGRAPH displays BBC graphics screens on an IBM display, and also converts them for use in Microsoft BASIC.

All three programs are very powerful, and in the hands of an experienced user could be made to do great things. However the manual is rather short on discussion of ideas, and examples, which makes it rather hard to grasp the feel of the product.

The other programs are useful utilities which emulate BBC '\*' commands such as \*FORMAT and make life easier in the PC environment. They are:

- BACC** Lock/Unlock BBC files
- BBACK** Backup BBC disk
- BCDIR** Create ADFS directory
- BCOMP** Compact BBC disk
- BDIR** Change ADFS directory
- BFORM** Format BBC disk
- BMAP** Display free space on ADFS disk
- BREN** Rename BBC files
- BTOPT** Alter !boot option/title
- BWIPE** Delete BBC files.

Also supplied on the disk are some Microsoft Windows .PIF files which allow you to call up the programs in a point and click way; but only if you are one of the few people who have this ikon based front end. I also tested the programs under GEM, but in my opinion the best way to run the programs is by using your own custom designed BATCH files.

For the uninitiated a BATCH file on MS-DOS computers is a text file containing commands with the file extension .BAT which, when you type in its name at the > prompt, executes as if typed in at the keyboard, very much like EXEC files on a BBC. BATCH files however also have a mini programming language built-in, allowing loops, pauses, parameter passing, text input etc. This means that the experienced programmer can build up a system of BATCH files that control the operation of the computer and shield him or her from too much tiresome interaction with the operating system software. For this reason I am glad that Microboss decided to provide the programs as separate utilities, rather than as a menu driven program, thus providing maximum flexibility for programmers. Incident-

ally one of the BATCH files supplied SHOW.BAT did not work correctly, but was soon fixed by altering a couple of lines.

### In use

The acid test was for me to write this review on IBM compatible using *Wordperfect*, and then transfer the text file over to the BBC for sub-editing, and preparation for typesetting in *Wordwise+*. This worked very well once I had realised that straight text files transfer easiest, and I had the syntax of the commands correct. Repeating commands with long strings of parameters after them can soon become tiresome, so I was glad of my memory resident line editor DOSEDIT, which allows instant recall of your last command for editing. One minor irritation was that the program does not seem to allow ambiguous (multiple) IBM filenames, whereas it is possible on the BBC side. Another small problem was that if you failed to set the correct filing system to use with BDOS, you could often start the other utilities, but they would fail on a disk access. Perhaps a "Hot-Key" to display the set filing system would help here.

I also tested BGRAPH briefly, transferring over a picture file without any problems, but this program is potentially so useful that it could do with a chapter all to itself in the manual to explain its uses.

### Summary

This is product that, if you need, you must get. If you don't need it then you will not understand what all the fuss is about. We at *Disk User* have been badgering MicroBoss for some time now to get Beebdos because we believe there is an unfulfilled need for this kind of product, and it is something we would use ourselves. Also the professional programmer interested in getting code from one machine to the other will find the utilities invaluable in speeding that process up.

In short, although to be approached with care, and possessing rough edges, Beebdos is the sort of program that would definitely earn its keep.

### Disk Data

Beebdos is available from Microboss, 3 Hadleigh Road, Frinton, Essex, CO13 9HG. ☎ 02556 71095.

Mark Gidley

**MENU PAGE ONE. OPTION TWO.**

# HOT KEY - ANYTIME ANYWHERE



**Instant OS will allow you to call any \* command with a single key press, from BASIC, wordprocessor or database. In fact during any operation you might be carrying out**

I was prompted to write the *Instant OS* program after a letter in a recent issue of *Disk User* asking for a means of printing what was on the screen at any time. With *Instant OS* this can be done provided a screen dump ROM or routine is installed and can be called with a \* command eg Computer Concepts Printmaster with \*GDUMP.

*Instant OS* has many uses apart from instant call-up of screen dump routines. These include cataloguing a disk, ROM information, any \*FX calls, returning to BASIC from programs and so on. And all this at any time (even half way through a listing, mid-play in a game and when typing text in *Wordwise* or *View*).



The program, when run, asks you to enter the desired OS command (it must be less than 21 characters long), and then it will initialise the routine by simulating a press of the <BREAK> key. A message is displayed to show that it is functioning correctly. To ensure initialisation press <CTRL> and <BREAK> together.

To activate the \* command, the @ key should be pressed. When the \* command has been executed, the machine will revert to normal operation.

# SERVICES

## ORDERING INSTRUCTIONS

Order back issues and subscription from Infonet Ltd. Order software and binders from ASP

Reader Services. Please make out separate cheques to speed the progress of your order.

## BACK ISSUES

Issues two to five are available in full colour magazine and floppy disk

Disk User Two:

Ants!  
Expert investigator  
Word Wars  
Automatic Disk Catalogue Utilities  
Mode 7 machine code  
Software Manager  
Guide to essential games on disk  
Operating with OSWORD  
Which RAM disk?

Disk User Three:

Cholo Player's Guide  
Auto Save  
Quick Break  
Tazman  
Dual catalogue creator  
Feeling the Squeeze  
Count with Teddy  
Quick Copy  
Calculator  
Utilities reviewed  
Archimedes and disks  
Collectors Items

Disk User Four:

SIDE 1:

Introduction to ADFS  
Blockade  
Collectors Items

Three dimensional graphics  
Random Access Tutorial  
Music Tutor  
Interceptor utilities  
Disk repair  
Repton screen printer  
New Repton 3 screens

SIDE 2:

Full Micronet demo

Disk User Five:

How your disk drive works  
Program transfer  
Arkenoid/Thrust cheats  
Ravenskull screen maps  
Magic Wall puzzle  
Save Your Bacon  
Disk User theme tune  
Disk routine library  
Overlay techniques  
Spock's logical disk menu  
Toolkit character editor

Back issues of Disk User cost £2.95 and £0.50 postage and packing. Disk User back issues and subscriptions are sent in special packaging to protect your software.

Send your remittance to:  
INFONET LTD, 5 River Park  
Estate, Berkhamsted, Herts HP4  
1HL.  
Tel: 04427 76661-4 for VISA and  
ACCESS credit card orders.

## SUBSCRIPTIONS

### SUBSCRIBE NOW!

We've made it easy to subscribe to Disk User. You can choose from a 6 monthly or 12 monthly subscription. Twelve disks full of quality software PLUS colourful magazine for just £35.40.

	6 months	12 months
UK	£17.70	£35.40
Europe	£21.60	£42.00
Middle East	£21.70	£43.40
Far East	£23.20	£46.40
Rest of the World	£22.00 or USA \$32.00	£44.00 or USA \$64.00

Airmail rates given on request.

## Software Manager

### MAIN - MENU

Write  
Retrieve  
Browse  
Extract  
Print  
Open file  
Quit

W/R/B/E/P/O/Q\_

No. of records : 85

## Software manager - on Disk User 2

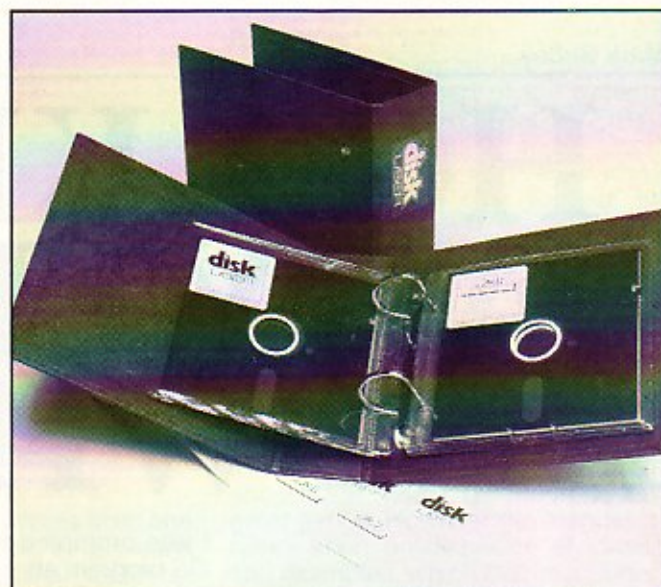

## BINDERS

Organise and protect your disks with Disk User disk binders and data disks. Why not keep your Disk User program collection alongside your magazines in a stylish Disk User disk binder? The binder contains 10 disk sleeves to organise, and protect, your program disks. And we've produced special Disk User data disks to match. The Disk User logo immediately identifies your Disk User program disks and there's room to

title them and document the relevant magazine details. Prices are as follows:

Disk User disk binder £4.95, which includes all postage and packaging  
Order product number BDAU1  
Disk User disk binder including 10 Disk User data disks £9.95, which includes all postage and packaging  
Order product number BDAU2



## PRODUCT CODE NUMBERS

PROGRAM TITLE	BBC B/B+	MSTR 128	COMPACT ELECTRON
Global View	DB01	DB16	DB33 DE06
Graphics Pack 1	DB03	DB17	DB37 DE01
Musician	DB06		
Mode 7 Utilities	DB12		
Adventurescape III	DB20	DB28	DB35
Combat Zone	DB21	DB30	DB32
Easy Font	DB26	DB39	DB44
ADFS Menu		DB27	DB31
Graphics pack 2	DB29	DB34	DB38 DE29
Colour Icon	DB36		
A&B Bibliography	DB40	DB51	
Bibliography Upgrade	DB55	DB54	
Statistics	DB41	DB42	DB43
Home Office	DB46		DE46
Graphics Constr. Set	DB49	DB50	DB51
Master Only		DB56	DB57
Getting Into Assembler	DB61	DB62	DB63
Wordwise Plus	DB64	DB65	DB66
Sideways RAM	DB67	DB68	DB69
Pascal	DB70	DB71	DB72
Adventure Special	DB73	DB74	DB75
Graphics Special	DB76	DB77	DB78
Skywatcher	DB79	DB80	DB81
Online!	DB82		
Disk User One	DUI		

## AVAILABILITY AND PRICE

**ALL SOFTWARE AVAILABLE ON 80 TRACK (ADFS LARGE) FORMAT. ADFS OWNERS ENQUIRE FOR 40 TRACK AVAILABILITY.**

## DISK USER ONE

Available only as a software product, floppy disk and laserset manual. Programs are:

Collectors Items  
Barmy Butterflies  
Cube of Zoth  
Auto Cataloguer  
Disk Examiner  
Karate Kid

Order product number DUI.

All the disk based products in our tables are available from Disk User Reader Services. Just fill in the order form with the appropriate product number and track format.

## SOFTWARE

9 Hall Road, Maylands Wood Estate, Hemel Hempstead, Herts HP2 7BH Tel: 0442 41221

CHECK WITH THE TABLES TO SEE IF OUR SOFTWARE IS AVAILABLE FOR YOUR COMPUTER. PLEASE INDICATE YOUR REQUIRED PRODUCT NAME, NUMBER AND TRACK FORMAT IN THE ORDER FORM

Software is only available on the formats recorded in the tables.

All prices include VAT and postage and packing. Please make cheques/postal orders payable to Arqus Specialist Publications Ltd and print your name and address clearly on the back of your cheque. Telephone orders are taken for Visa and Access. All software is sent first class. Prices include postage and packing for European destinations. Please include £1.00 postage and packing (airmail) for other overseas order. Please allow 28 days for delivery.

Name	Product	Price
Global View	DB01	£10.00
ADFS	DB16	£10.00
Graphics Pack 1	DB03	£10.00
ADFS	DB17	£10.00
Musician	DB06	£8.00
Mode 7 Utilities	DB12	£8.00
Adventurescape III	DB20	£15.00
ADFS	DB28	£15.00
Combat Zone	DB21	£8.00
ADFS	DB30	£8.00
Easy Font	DB26	£10.00
ADFS	DB39	£10.00
ADFS Menu	DB27	£12.00
Graphics pack 2	DB29	£10.00
ADFS	DB34	£10.00
Colour Icon	DB36	£8.00
A&B Bibliography	DB40	£15.00
ADFS	DB51	£15.00
Statistics	DB41	£10.00
ADFS	DB42	£10.00
Home Office	DB46	£10.00
Graphics Construction Set	DB49	£10.00
ADFS	DB50	£10.00
Bibliography Upgrade	DB55	£6.00
Master Only ADFS	DB56	£8.00
A&B '87	DB58	£8.00
ADFS	DB59	£8.00
Getting Into Assembler	DB61	£10.00
ADFS	DB62	£10.00
Getting Into Wordwise Plus	DB64	£10.00
ADFS	DB65	£10.00
Getting Into Sideways RAM	DB67	£10.00
ADFS	DB68	£10.00
Getting Into Pascal	DB70	£10.00
ADFS	DB71	£10.00
Adventure Special	DB73	£22.00
ADFS	DB74	£22.00
Graphics Special	DB76	£22.00
ADFS	DB77	£22.00
Skywatcher	DB79	£8.00
ADFS	DB80	£8.00
Online!	DB82	£10.00
Disk User One	DUI	£4.00

## SOFT SALE ORDER FORM

PRODUCT NAME	PRODUCT NUMBER	DISC Please specify 40 or 80 track	QUANTITY	PRICE
			<b>TOTAL</b>	

Name.....

Address.....

Postcode.....

Signed.....

Date.....

I enclose a cheque/postal order made payable to ASP for

£.....

Please complete the form in block capitals and send it with your remittance to Software Sale, Reader Services, 9 Hall Road, Maylands Wood Estate, Hemel Hempstead, Herts HP2 7BH. Tel: 0442 41221. You can direct technical enquiries about software to Phoenix Software on 0733 53355.

# disk

# LINK

TO ADVERTISE IN THIS  
NEW SECTION — RING

MARK LINACRE ON 01-437 0626

## Quality Disks

Unbranded Lifetime Guarantee

Qty.	10	25	50	100	200
5.25" DS/DD 48tpi	5.70	11.00	19.00	34.00	61.00
5.25" DS/DD 96tpi	6.10	12.50	20.50	36.00	69.00
5.25" HD 1.6Mb	16.00	36.00	70.00	130.00	250.00
3.5" DS/DD 135tpi	11.50	26.60	51.90	98.00	189.00
3.5" SS/DD 135tpi	10.95	25.50	48.90	95.00	185.00

Branded 5.25" 48 TPI 3m DS/DD — Pack of 10 for £10.00.

Please Call for 200+ Quantity Discounts.

Larger Capacity Cases from £10.00.

5.25" 10 Disk Plastic Lib. Case £1.50/3.5" 10 Disk Plastic Lib. Case £1.30.  
All Disks supplied with Labels, 5.25" also have sleeves  
and write protects. Price inc. VAT & P&P (U.K.)

Unbranded does not always mean poor quality, why not take advantage of our 14 day  
money back guarantee and try a trial pack of 10 disks.

Credit Cards Welcome

Telephone 0329 282083 (24 Hours)

Cheques/PO to: Athene Consultants, Dept. (DU),  
33 Holly Grove, Fareham, Hants. PO16 7UP.

**SPEEDY DESPATCH** **VISA**

**FREE** **HIGH QUALITY**  
**JAPANESE HIGHGRADE**  
5.25" DS/DD disks

Deluxe 120 disk capacity lockable disk box worth over £14. (Please state if you want the 100 capacity box instead)

Large storage case totally FREE with the following quantities of high quality Japanese disks

**25 disks ..... £18.25** All inclusive of Post & VAT  
**50 ..... £27.50**  
**100 ..... £44.50**

**PRICES DOWN AGAIN**

**FREE — ILLUSTRATED CATALOGUE WITH EVERY ORDER.**

**N** Nebulae, Dept. MN, FREEPOST, Kilroot Park, Industrial Estate, Carrickfergus, Co. Antrim, BT38 7BR. TEL (09603) 51020 (Monday to Friday 9 to 5).  
7 Day Delivery & 14 day money back period  
We accept orders from all government bodies, schools, universities, PLC's etc. We despatch on receipt of an official purchase order.

**FREE**

**Tel: (09603) 51020**

**FREEPOST YOUR ORDER TODAY — NO STAMP REQUIRED**

## BeebDOS version 2 (new)

from MicroBoss

### Software for BBC and IBM file interchange

Runs on IBM-PC-XT-AT or compatibles and supports DOS 2.0 or later

Supplied on 360K IBM diskette with manual and plastic wallet the software includes:

- BCOPY** Copy files BBC — IBM, IBM — BBC, BBC — BBC (wild cards allowed)
- BCONV** Flexible IBM file translate facility enabling text to be passed between VIEW, WORDSTAR and Displaywrite 3 amongst other uses.
- BGRAPH** Display BBC mode 0, 1, 4, 5 screen format (AMX Art included) files on IBM standard colour (CGA), enhanced colour (EGA) or Hercules screens for use in IBM PC presentation, DTP, drawing and other graphic applications.

BeebDOS is almost a complete BBC DFS/ADFS for the IBM PC with utilities to catalogue, format, backup, delete, lock, unlock, compact rename, alter title & options, map free space, change and create directories of BBC diskette/files.

Infact BeebDOS is probably the fastest and most powerful BBC/IBM PC file transfer method available and no cables or serial connections are required.

BBC double density diskette formats supported are Acorn ADFS, Watford, Solidisk, OPUS DDOS and UDM. Acorn single density DFS is only supported when running BeebDOS on an IBM AT or XT286 with a 360k disk drive. Please send or phone for an information sheet.

**£39.99**  
Inclusive

CHEQUE OR POSTAL ORDER TRADE/EDUCATIONAL ENQUIRIES WELCOME  
MICROBOSS LTD 3 HADLEIGH RD FRINTON ESSEX CO13 9JG TEL: (0255) 671095

AUDIO • COMPUTING • MUSIC • DOMESTIC  
APRIL 1988 £1.40

**ETI**  
ELECTRONICS  
TODAY INTERNATIONAL

**VIRTUOSO**  
Super-fit power  
amp project

CAPACITORS:  
the inside story  
FIRST CLASS  
beginners project  
series starts inside

**NEW LOOK!**

AUDIO • COMPUTING • MUSIC • DOMESTIC

# The New

# ETI

## ELECTRONICS TODAY INTERNATIONAL

hits the newstands on  
March 4th at just £1.40!

*Ingenious projects and instructive features  
plus the latest news, reviews and comment  
to keep you in touch with electronics today*

IT'S SURPRISING THE TYPE OF PEOPLE  
MAKING THE HEADLINES THESE DAYS.



### STOP PRESS

'Stop Press' puts you right at the heart of the Desktop Publishing Revolution. Utilising dynamic WYSIWYG (What You See Is What You Get) facilities, 'Stop Press' makes it simple to create professional newsletters, leaflets, flyers, forms or in fact anything where text and graphics are required.

'Stop Press' is the ideal publishing software solution for home enthusiasts, schools, societies and small businesses.

### READ ALL ABOUT IT

Documents may be prepared using any of the superb selection of typefaces (12 or more) supplied or alternatively a typeface of your own design.

Text can be entered from within 'Stop Press' or imported from your preferred word processor with fully automatic on-screen text formatting as the file loads.

Centering, ragged right, and literal justification are all available. There also is full pixel resolution control over character size and spacing.

### GRAPHIC DESIGN

As well as the ability to import digitised images there are outstanding facilities for drawing, spraying and painting using either the patterns supplied or your own pattern designs, enabling you to produce graphs, charts, diagrams and pictures.

These can then be pasted, cropped or re-sized to fit any layout, and for those finishing touches a fantastic zoom is available.

### HOT OFF THE PRESSES

At anytime your pages can be previewed before being output to a wide range of Epson or compatible dot matrix printers.

### AMX MOUSE

'Stop Press' can be used with a joystick or keyboard but the AMX MK III Mouse gives you the control and flexibility which you would expect from the most accurate pointing device available. Produced in Switzerland the AMX Mouse has a unique patented design which includes high resolution movement (D.P.I.) and superior ball technology to ensure that contact between the Mouse and surface is constant at all times.

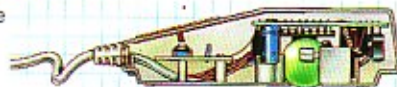

### EXTRA! EXTRA!

Complimenting 'Stop Press', Extra! Extra! is a superb collection of ready made clip art and new typefaces covering a wide variety of subjects and styles.

'STOP PRESS' IS AVAILABLE FOR	SOFTWARE ONLY	WITH AMX MK. III MOUSE	EXTRA! EXTRA!
ACORN BBC/B + MASTER	£49.99	£79.99	£24.99
AMSTRAD PCW 8256/8512	£49.99	£89.99	—
AMSTRAD CPC 6128	£49.99	£79.99	£24.99
COMMODORE 64/128	£39.99	£69.99	—

These superb products are available from all good computer dealers or direct by cheque, Access or Visa. All prices include VAT, postage and packing. Become your own publishing baron with 'Stop Press' and start the presses rolling.

# AMS

ADVANCED MEMORY SYSTEMS LIMITED

Imagination at your fingertips

FOR INSTANT ACCESS OR VISA ORDERS TELEPHONE: (0925) 413501.

ADVANCED MEMORY SYSTEMS LIMITED 166-170 WILDERSPOOL CAUSEWAY, WARRINGTON WA4 6QA.

TELEPHONE: (0925) 413501 TELEX: 628672 AMS G FAX: 0925 58039

TUBELINK ON MICRONET 800 TUBELINK \* SUPPORTS THE AMX MOUSE AND ALL AMS SOFTWARE



Featuring  
4 Chartbusters

# Play It Again Sam 2



## SUPERIOR'S BEST COMPILATION YET

for the BBC Micro and Acorn Electron

**Sam**, an ardent fan of Superior Software's games, has been absolutely delighted by the success of his first selection of chart-topping Superior Software games. Now here's four more games that will keep you enthralled day after day — on that you can rely!

**Repton 3** is probably the best-loved of all of Superior's games. Our endearing lizard, Repton, is trapped in a netherworld amidst falling rocks, fearsome monsters and haunting spirits. A superb strategic game which includes character and screen designers enabling you to create your own scenarios. A & B Computing reported: "This is top quality; arcade action at its very best!"

**Craze Rider**, a fascinating motorcycle-racing game, features seven international racetracks. "It's fast, challenging and there's plenty to keep you entertained. Thoroughly recommended" remarked The Micro User.

**Galaforce** is the thinking-man's alien-zapping game; fast and furious, yet full of strategy. Oracle enthused: "You haven't lived until you've played this game. Buy it! — it's the ultimate in shoot-em-up. RATING: 20 (out of 20)"

**Codename: Droid** is a challenging arcade-adventure. The quality of the graphics and animation must be seen to be appreciated. Electron User summed the game up by saying "CODENAME: DROID is brilliant . . . it's worth every penny!"

BBC Micro Dual Cassette.....\$9.95 Acorn Electron Dual Cassette.....\$9.95  
 BBC Micro 5¼" Disc.....\$11.95 BBC Master Compact 3½" Disc.\$14.95

(Compatible with the BBC B, B+ and Master Series computers).

### THE ORIGINAL "Play It Again, Sam"

Our original selection of 4 of Superior's biggest hits for the BBC Micro and Acorn Electron is still available.

- CITADEL
- STRYKER'S RUN
- THRUST
- RAVENSKULL

**SUPERIOR SOFTWARE**  
Limited

**ACORNSOFT**

Dept. 2P510, Regent House, Skinner Lane, Leeds LS7 1AX. Telephone: 0532 459453.

Please make all cheques payable to "Superior Software Ltd."



24 HOUR TELEPHONE ANSWERING SERVICE FOR ORDERS

**OUR GUARANTEE**

- All mail orders are despatched within 24 hours by first-class post.
- Postage and packing is free.
- Faulty cassettes and discs will be replaced immediately. (This does not affect your statutory rights)