

The best-selling Acorn magazine in the world

ACORN USER

Essential for all users of 32-bit RISC OS computers

Strong ARM

All you ever
wanted to
know about
the fastest
upgrade ever

The best
guide to the
Acorn World
Show

- Your big guide to the Acorn World Show
- Hi-res online video editing
- MIDI explained and explored
- Rainbow CD from RESOURCE

NOVEMBER 1996
ACORN USER Cover Disc

Inferno

Superb levels of this fast action playable demo from Paradise and the Dream Team

- Flashback music player
- IBrowse compact JPEG and Sprite viewer
- Wimp programing in C
- Plus all the •INFO software



CHECKED ● VIRUS CHECKED ● VIRUS CHECKED ● VIRUS CHECKED ● VIRUS CHE

November 1996 Issue 174 £3.25

IDG MEDIA



9 770263 745086 1.1 >

The most popular range of scanners

FOR ACORN RISC COMPUTERS



SCANLIGHT 256

**THE CLEAR LEADER
IN SCANNING SOFTWARE
FOR THE ARCHIMEDES**

The ScanLight 256 scanner offers a maximum resolution of 400 dpi true 256 grey-levels at full 105mm width. In addition there is support for monochrome, 16 grey level and 256 grey-level scanning at 100, 200, 300 and 400 dpi. The latest scanner model offers a convenient one-touch scanning button and a unique overscan buzzer which gives an audio warning when you are scanning too fast. A handy ruler is also supplied to ensure perfectly straight scans. The ScanLight software offers several unique facilities that make it the leader in its field - e.g. the ability to provide all picture processing and enhancement functions with only the one original copy of the image in memory - vital since scanned pictures require a great deal of memory.

The perfect way to capture high quality pictures for inclusion in DTP or practically any other RISC OS application.

The ScanLight software offers:

- Instant image rotation by any angle.
- Support for the RISC OS 3 true 256 grey-level sprite format.
- Only one copy of the image in memory at once.
- On the fly screen dithering for maximum image quality.
- A selection of sampling sizes from 2x2 to 8x8.
- Image enhancement facilities such as sharpening, edge detect etc.
- Simple brightness and contrast controls.
- Spline curve control over grey-map for additional control.

ScanLight 256 scanner, guide ruler, interface board, manual and software :

For the 300/400/5000 & Risc PC: £129.00 + VAT (£151.57 inc)

For the 30X0 and 4000 internal card: £139.00 + VAT (£163.32 inc)

Specify machine type when ordering. Requires 2MBytes. No carriage is charged.

You can purchase a second card for any Acorn model for just £39.00 + VAT (£45.82 inc) - no need to move the board when you want to use ScanLight on a second machine.



Computer Concepts Ltd

GADDESSEN PLACE HEMEL HEMPSTEAD HERTS HP2 6EX TELEPHONE 01442 351000 FAX 01442 351010

THE FAR SITED OPTION!



SEE US AT
STAND No. 106

If your site has more than three machines then a site licence might be your best option.

Site licences were originally designed with schools in mind, but they work equally well for any organisation that has several machines on one site. The exact number at which a site licence becomes economical varies with the product, but if your site has more than three machines then it's worth investigating further.

Impression Publisher, Impression Style, TurboDrivers and ArtWorks are the most popular licences. The software can be supplied for use over networks or on stand alone machines (same price, but please specify). Network licences are AUN

Impression Style £350+VAT
(£411.25 inc)

Impression Publisher £440+VAT
(£517.00 inc)

ArtWorks £440+VAT
(£517.00 inc)

**TurboDriver & LaserDirect
network spooler £149+VAT**
(£175.07 inc)

We have site licence arrangements for most other software products. Please ask for details.

compatible and can run over Econet, Ethernet

or Nexus networks.

The licence fee includes one complete package with manuals. The current purchase price of a single copy, if one is already owned and registered, can be offset against the fee. The licence covers up to 20 machines, but for the larger sites additional units of 10 can be bought at a later date

Think of it this way; if your site has 20 machines, an Impression Publisher network licence works out at £22 per copy, when the RRP is £129. We're sure you will agree that this pricing is attractive, which is why 4000+ sites have Computer Concepts licences.



Computer Concepts Ltd

Contents

Editor's letter

Unless you've just arrived from Mars you'll no doubt be aware that the Acorn World show is the happening thing at the beginning of November.

In this issue we're providing the most up-to-date guide to whose there and what they'll be showing at the new Olympia venue.

In the interviews and chats we've had with the Acorn staff it's clear that they're just as excited about the show as the rest of us and it does promise to be packed with amazing new products — and I don't just mean the StrongARM.

Battle has been joined in the video editing arena with Eidos wading back into the fray with the StrongARM power and Irlam's fantastic quality Videodesk system — offline video editors have only two decent low-cost choices and they're both Acorn.

If we take all the niches there'll be nowhere for our opponents to retreat to when the Net Computer hits them from the front.

What did you do in the web-war?

Steve Turnbull

Managing Editor Pam Turnbull

Editor Steve Turnbull

Production Editor Alan McLachlan

Art Editor Jim Eagers & Alan Capper

Assistant Editor Karen Peach

Contributing Editors

Ian Burley (News) Steve Mumford (Games)

Jack Kreindler (Graphics) David Dade

(Comms) Paul Wheatley (Public Domain)

Geoff Preston (Education) Graham Nelson

(Games) Mike Buckingham (PC)

Advertisement Manager Lisa-Jo Oliver

Advertisement Sales Sally Cadwaladr

Ad Production Barbara Newall

Ad Typesetting Eddie Burke

Marketing Manager Steve Tagger

Marketing Assistant Gary Russell

Production Manager Karen Wright

Commercial Director Denise Wright

Circulation Director David Wren

Distribution COMAG (01895) 444055

Subscriptions & Back Issues

Database Direct 0151-357 1275

Email: database@dbdirect.demon.co.uk

Managing Director Ian Bloomfield

Cover Jim Eagers

Member of the Audit Bureau of Circulation
Acorn User is an independent publication
and Acorn is not responsible for any of
the articles in this issue or for any of the
opinions expressed.



Published by IDG
Media Ltd, Media House, Adlington Park,
Macclesfield SK10 4NP
e-mail aueditor@idg.co.uk

http://www.idg.co.uk/acornuser/
Tel: (01625) 878888 Fax: (01625) 850652
Printed by Duncan Web Offset, Maidstone

13 issue subscription rate: £39.99 (UK),
£53.99 (EU), £68.99 (World)

©1996 IDG Media Ltd.

No material may be reproduced in whole
or in part without written permission. While
every care is taken, the publishers cannot
be held legally responsible for any errors in
articles, listings or advertisements

REGULARS

9 News
Five pages of up to the minute news



19 Graphics
News of a service for Acorn graphics users only

21 PD
Two pages of the latest in the public domain

25 Comms
Next stop the Sidings BBS

27 PC Column
News on !PCPro, the undated version

29 Cover Disc
Playable demo of Inferno plus lots more

81 Game Show
A challenge from Krisalis plus designs for design



86 Free Ads
Pick up a bargain in these pages

94 Back issues
Complete your collection while stocks last

102 Subscribers' page
Get AU delivered to your door

104 Letters
Air your views on the pages of Acorn User

106 The Regan Files
George Buchanan from Dalriada Data Technologies

HANDS ON

89 *INFO
Another mind-blowing array of programs & tips

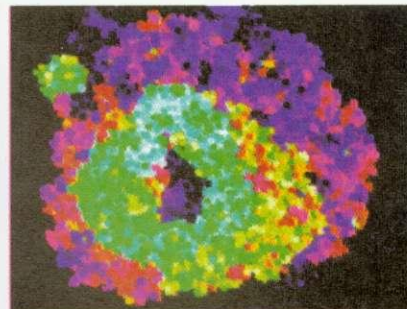

96 Sounds Simple
Mike tidies up his sound system

99 C Tutorial
More on programming the WIMP

100 Rambles through Acorn Wood
Hints and tips from Mike Cook

EDUCATION

73 Editorial
The latest from the education world

75 Finding your way
Using global positioning systems while touring



78 Comparisons and contrasts
Compiling a geography and IT software package

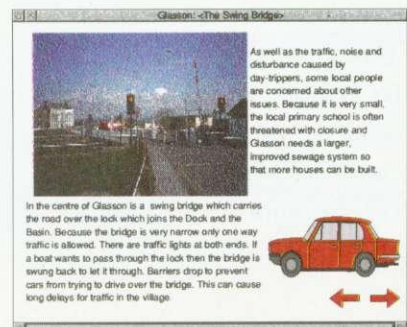

REVIEWS

60 Nursery Land revisited
A preview of a new software package from RESOURCE



67 Making movies
A look at Videodesk from Irlam Instruments



Everything you need to know to plan your visit to Acorn World. Includes a stand-by-stand guide, floor plan and theatre program details. .
see page 34

Acorn
WORLD

FEATURES

49 StrongARM is here!
Have you put an order in for yours yet?

55 Midi maestro
A brief guide to MIDI and its surrounds

69 Colourful pages
The next in our series explaining HTML



PLUS! Special Acorn World subscription offer
see page 46

29

Play the demo of the fast action game Inferno. There's also a Processor Vector Module, Flashback music player, IBrowse – a Sprite and JPEG viewer – plus all the regulars.



49

StrongARM is here! Mike Cook talks to Chris Cox and Dave Walker from ART.

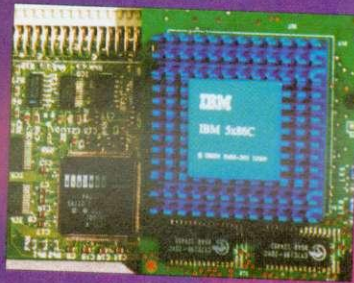

60

Geoff Preston visits RESOURCE to preview their latest project which involves nursery rhymes and lots of celebrities.

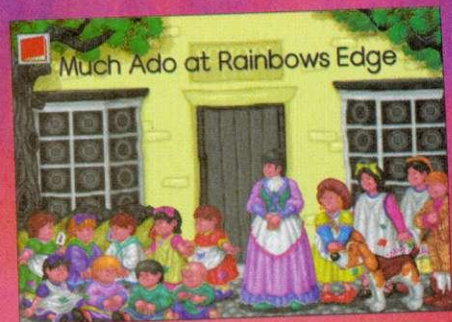

Next month in Acorn User

Printer reviews, Prosound review, SCSI vs IDE and all the regular items are just the tip of iceberg as we kick off our December issue with a new series on creating arcade action games by creator of *Swarm* Matthew Bloch. Plus a detailed feature on the inter-application protocol from Clares. Don't miss it!

**NEXT
ISSUE
ON SALE
31 October**

PicturePoint FD, KS1,2	Longman	£35.25	£30
PinPoint 2, KS3,4	Longman	£92.83	£79
PinPoint Datable Animal Kingdom, KS2,3	Longman	£16.45	£14
PinPoint Datable Diet and Nutrition, KS3,4	Longman	£16.45	£14
PinPoint Datable Second World War, KS3,4	Longman	£16.45	£14
PinPoint Datable Solar System, KS3,4	Longman	£16.45	£14
Placard	KS	£11.75	£10
Plantwise FD, age 9-14	Sherston	£49.35	£42
Playdays, age 3-8	SkilbW	£24.68	£21
Playground, KS1	Toplog	£24.68	£21
Plot	Clares	£74.03	£63
Podd, KS1,2	ESM	£22.33	£19
Prehistoric Animals Graphics	Micro S	£17.63	£15
Primary Teacher's Clip Art Starter Set	Toplog	£13.28	£13
Primesolver Full version, KS1-4	Minerva	£57.58	£49
ProArtisan 24 (Risc PC only)	Clares	£98.70	£84
ProCAD, KS4	Minerva	£292.58	£249
Propheet 2	Arpicote	£168.03	£143
PublishArt Release 2, Artworks format	Smart	£34.08	£29
PublishArt Release 2, Draw format	Smart	£34.08	£29
Puddle, KS1	Toplog	£19.98	£17

QuickKey

Rainbow, KS1,2	Longman	£35.25	£30	
Real McCoy 4	Fourth	£25.85	£22	
Recordz	Colton	£109.28	£93	
Report Writer, KS1-4	Creative	£56.40	£48	
Resaltz	Report	£88.13	£75	
Revelation ImagePro 24 bit, limited offer,	KS2,4	Longman	£45.83	£39

Revolver

Rhapsody 2	Psychic	£14.10	£12
Rhapsody 3	Clares	£56.40	£48
Rhythm-Bed	Clares	£86.95	£74
Rick Dangerous	Clares	£44.65	£38
Ridiculous Rhymes FD, age 7+	Hiten	£12.93	£11
RISC OS 3 First Steps	Sherston	£45.83	£39
RISC OS 3 Programmer's Reference Manual v1-4	Dabs	£7.00	£6

Dabs Guides only £7

ArtWorks Made Easy
Budget DTP
C Guide
Graphics on the ARM Machines
Impression
Risc OS 3 First Steps

or FREE with one of these

ArtWorks • Big Picture C/C++ • Easy C (++)
Impression Style
Impression Publisher (Plus)
Pendown • Photodesk
ProArtisan 2 or 24
Textease
Risc OS 3.1 upgrades

or FREE with one of these

RISC OS 3.1 Documentation	Acorn	£105.00	£105
RISC OS 3.6 Programmer's Reference Manual v1-4	Acorn	£32.90	£28
RISC PC Technical Reference Manual	Acorn	£55.00	£55
Roll VIT	Paragon	£24.68	£21

Rosie and Jim

Duck loses his Quack, age 3-6	Sherston	£11.75	£10
Rosie and Jim: Jim gets the Sneezes, age 3-6	Sherston	£11.75	£10
Round the World Yacht Race, age 9+	Storm	£28.20	£24
Rift and WordPerfect Loaders and Savers	CC	£32.90	£28
Sally and Wally	Oregon	£23.50	£20
Saloon Cars Deluxe	Fourth	£25.85	£22
Saloon Cars Deluxe Extra Courses	Fourth	£17.63	£15
S-Base 2 Developer	Longman	£108.10	£92
S-Base 2 Personal	Longman	£55.23	£47
Schema 2	Clares	£111.63	£95
Schem Draw	Clares	£51.70	£44
SearchTurtle, KS1-3	Toplog	£39.95	£34
Screen and Rescue, age 9+	Storm	£28.20	£24
Sea Rescue, age 7-9	Sherston	£29.38	£25
Seashore Guide	Micro S	£17.63	£15
SecureIT-Plus	Cambs Soft	£34.08	£29
Seelinks - Ourselves, KS1,2	ESM	£31.73	£27
Serenade	Clares	£88.13	£75
Shakespeare Show	Toplog	£45.83	£39
ShapeFX	Data Store	£10.58	£9
Sibelius 6, KS3,4	Sibelius	£180.95	£154
Sibelius 7	Sibelius	£974.08	£829

Sim City

limited offer	Krisals	£23.50	£20
Sim City 2000 for Risc PC	Krisals	£29.38	£25

Topographer	Clares	£69.33	£59
Touch Type	Iota	£44.65	£38
Trace	Pilling	£10.58	£9
Treacka	TBA	£19.98	£17
TurboDriver Canon	CC	£45.83	£39
TurboDriver Epson Stylus 800	CC	£45.83	£39
Twin Canon HP incl Scan-Light Professional	CC	£45.83	£39
Twain Epson GT8000, 6500	Pilling	£18.80	£16
Twain HP Scanjet II, Iic, Ilex	Pilling	£18.80	£16
Twain Pilling	Pilling	£18.80	£16

IDE hard disc kits

The best IDE filing system

- Password protection • Disc partitioning •
- Not limited to 512 Mb •

Please specify OS 2 or OS 3 for all kits and interfaces
All ICS CD products require RISC OS 3.1 or later

A3000 CD bargains

Do you already have an ICS IDE interface?
Would you like a 4-speed CD for £185?

240 Mb	KS	£198.58	£149
540 Mb	KS	£233.83	£199
1000 Mb	KS	£276.13	£235

IDE CD only kits

- ALL ICS CD PRODUCTS REQUIRE RISC OS 3.1 -

4-speed for A3000 Series	ICS	£264.38	£225
4-speed for Archimedes	ICS	£245.58	£209
4-speed for Risc PC	ICS	£146.88	£125
4-speed + HD FS for A3000 Series	ICS	£277.30	£236
4-speed + HD FS for Risc PC	ICS	£159.80	£136
6-speed for A3000 Series	ICS	£241.93	£201
6-speed for Archimedes	ICS	£227.83	£197
6-speed for Risc PC	ICS	£227.95	£194
6-speed + HD FS for A3000 Series	ICS	£354.85	£302
6-speed + HD FS for Risc PC	ICS	£240.88	£205
IDE CD Interface for A3000 Series	ICS	£83.43	£71
IDE CD Interface for Archimedes	ICS	£68.15	£58
IDE CD Interface for Risc PC	ICS	£64.63	£55
IDE CD + HD Interface for Risc PC	ICS	£77.55	£66

IDE HD + CD kits

- FOR A3000 SERIES -

- ALL ICS CD PRODUCTS REQUIRE RISC OS 3.1 -

80 Mb + 4-speed	ICS	£381.88	£325
80 Mb + 6-speed	ICS	£468.83	£399

Hard discs & CDs

IDE CD Drive 4-speed	ICS	£92.83	£79
IDE CD Drive 6-speed	ICS	£188.00	£160
IDE 2 1/2" Hard Disc, 240 Mb	ICS	£128.08	£109
IDE 3 1/2" Hard Disc, 540 Mb	ICS	£175.08	£149
IDE 3 1/2" Hard Disc, 1000 Mb	ICS	£217.38	£185
IDE HD Interface for A3000 Series	ICS	£88.13	£75
IDE HD Interface for Archimedes	ICS	£70.50	£60
IDE HD Interface for Risc PC	ICS	£70.50	£60
IDE HD Interface + User Port for A3000 Series	ICS	£52.83	£45
Hard Disc Cradle Kit for Archimedes	ICS	£17.63	£15
Hard Disc Fitting Kit for A3000	ICS	£8.23	£7
Hard Disc Fitting Kit for A3020	ICS	£8.23	£7
Hard Disc Fitting Kit for Risc PC 5 1/4" bay	ICS	£23.50	£20
Hard Disc Form Factor Converter 2 1/2" to 3 1/2"	ICS	£8.23	£7
Second Hard Disc Fitting Kit for A5000	ICS	£17.63	£15
Second Hard Disc Y Power Lead	ICS	£8.23	£7

Removable discs

IDE Removable Hard Disc Kit for A5000, 270 Mb	ICS	£421.83	£359
IDE Removable Hard Disc Kit for Risc PC, 270 Mb	ICS	£421.83	£359
IDE 3 1/2" Removable Hard Disc Cartridge, 105 Mb	ICQuest	£61.10	£52
IDE 3 1/2" Removable Hard Disc Cartridge, 270 Mb	ICQuest	£64.63	£55
Removable Hard Disc Fitting Kit for A5000	ICS	£29.38	£25
Removable Hard Disc Fitting Kit for Risc PC 5 1/4" bay	ICS	£23.50	£20

POSTAGE IS FREE FOR PREPARED SALES IN THE UK



Acorn Risc PC

Risc PC700 5M HD540 14" Monitor	1526.33	£1299	
Risc PC700 5M HD540 4x CD 14" Monitor	1643.83	£1399	
Risc PC700 10M HD1GB 14" Monitor Acorn	1761.33	£1499	
Risc PC700 10M HD1GB 17" Monitor Acorn	2113.83	£1799	
Risc PC700 10M HD1GB 4x CD 14" Monitor	1878.83	£1599	
Risc PC700 10M HD1GB 4x CD 17" Monitor	2231.33	£1899	
CS X86-100 Card for Risc PC	Alph	£464.13	£395
Ergo Keyboard for Risc PC	Castle	£44.65	£38
Power-tec SCSI II Card for Risc PC	Altyemcs	£204.45	£174
Risc PC 1 - 2 Mb VRAM Upgrade	Atomwide	£116.33	£95
Risc PC 2 Mb VRAM	Acorn	£229.13	£195
Risc PC Case Upgrade	Acorn	£116.33	£99
Risc PC Sound Card	Acorn	£68.15	£58
Risc PC x86 Card 5x86	Acorn	£67.65	£58
Risc PC x86 Card DX2-66	Acorn	£291.40	£248
Risc PC x86 Card DX4-100	Acorn	£350.15	£298
SCSI II Interface for Risc PC	Cumana	£193.88	£165
SIMM 4 Mb 32 bit		£13.35	£35
SIMM 8 Mb 32 bit		£7.58	£9
SIMM 16 Mb 32 bit		£104.58	£89
SIMM 32 Mb 32 bit		£199.75	£170
StrongARM SA-100	Acorn	£291.40	£248

Acorn portables

A-Link for Pocket Book	Acorn	£9.93	£51
Flash Disc 512K for Pocket Book	Acorn	£92.83	£79
Flash Disc 1 Mb for Pocket Book	Acorn	£119.85	£102
Mains Adaptor for Pocket Book	Acorn	£18.80	£16
Parallel Link for Pocket Book	Acorn	£32.90	£28
Pocket Book II 256K	Acorn	£238.53	£203
Pocket Book II TMB	Acorn	£316.08	£269

Other hardware

A305/310/440 RISC OS 3 Carrier Board	IFEL	£22.33	£19
A7000 4M HD540	Acorn	£56.33	£899
A7000 4M HD540 4x CD	Acorn	£173.83	£999
Auto-Scan 1438 Monitor (14")			
AKF 50 alternative			
Auto-Scan 1450 Monitor (14")			
AKF 60 alternative			
Backplane, 4-slot 4-layer with fan			
ColorMobile Direct Scanner for Windows	Primax	£175.08	£149

DeskTV Entry level	Yellowstone	£192.70	£164
DeskTV Standard (with Tuner)	Yellowstone	£232.05	£198
DMI 30	Audio	£106.93	£91
DMI 50 - S	Audio	£192.70	£164
Ergo Keyboard	Castle	£115.15	£98
Ethernet Interface, A400 Ibase2+T Access+	Atomwide	£116.33	£99
Fan Kit for A300 / A400 Series	ICS	£17.63	£15
GamesPad Dual	GamesW	£35.25	£30
GamesPad Pro Dual	GamesW	£39.95	£34
GT-5000 A4 Colour Flatbed Scanner (parallel port)	Epson	£410.08	£349

ITV	Irham	£197.40	£168
Lambda16	Irham	£115.15	£98
Midi Max	CC	£79.90	£68
Midi Port Standard Module for A5000, A7000, Risc PC	Acorn	£63.45	£54
Movie Magic	CC	£68.88	£245
Mozart Digital Audio	Yellowstone	£267.33	£239
PD Cartridge, 650 Mb Rewritable	Panasonic	£44.65	£38
Power Switch	GamesW	£19.98	£17
PowerWAVE 50XG	Audio	£292.58	£249
Printer Port Sampler	VTI	£57.58	£49
RISC OS 3.1 3 Set Rom Pack	Acorn	£88.13	£75
RISC OS 3.1 10 Set Rom Pack	Acorn	£292.58	£249
RISC OS 3.1 Software Upgrade with documentation	Acorn	£45.83	£39

RISC OS 3.1 Software Upgrade without documentation	Acorn	£78.73	£67
ScanLight 256	CC	£150.40	£128
ScanLight 256 for A3000/3010/3020/A4000	CC	£162.15	£138
ScanLight Video 256 A310/400/5000/Risc PC	CC	£220.90	£188
ScanLight Video 256 A3000/A4000	CC	£220.90	£188
Sound Force 1 Multimedia PC Speaker System	QuickShot	£39.95	£34
US Robotics E112.80 E96	US Robotics	£179.78	£151
XOB 177.43 E153	XOB	£177.43	£153
XOB 420.65 E358	XOB	£420.65	£358
XOB 184.48 E157	CC	£184.48	£157
User Port Analogue / MIDI for A3000 Series and A4000	Acorn	£68.15	£58

User Port Analogue / MIDI for A5000, Risc PC	Acorn	£9.70	£84
Vision 24 A3000/3010/3020/A4000 internal	HCCS	£102.23	£87
Vision 24 A5000/400/300/Risc PC	HCCS	£102.23	£87
Vision 24 S08 Line A3000/3010/3020/A4000 internal	HCCS	£136.30	£116
Vision 24 S08 Line A5000/400/300/Risc PC	HCCS	£136.30	£116
Vision Master Colour Monitor 15"	iyama	£295.00	£295
Vision Master Colour Monitor 17"	iyama	£450.00	£450
Vision Master Colour Monitor 17" Pro	iyama	£450.00	£450
Whisper Fan Quieter (for A300/A400 Series only)	ICS	£17.63	£15
Wizzos for A5000	ICS	£45.83	£39

Memory

A305/310/440 1 - 4 Mb	IFEL	£138.65	£118
-----------------------	------	---------	------



0151-625-1006

A3000 1 - 2 Mb, Upgradable	IFEL	£51.10	£52
A3000 1 - 4 Mb	IFEL	£44.65	£39
A3010 1 - 2 Mb	IFEL	£44.65	£38
A3010 4 Mb	IFEL	£92.83	£79
A3020 / A4000 2 - 4 Mb	IFEL	£86.95	£74
A5000 2 - 4 Mb	IFEL	£76.38	£65

Printers

BJ-30 Bubble Jet Printer (Black)	Canon	£162.15	£138
BJ-30 Bubble Jet Printer (White)	Canon	£162.15	£138
BJC-70 Colour Bubble Jet Printer (Black)	Canon	£210.33	£179
BJC-70 Colour Bubble Jet Printer (White)	Canon	£210.33	£179
Colour Bubble Jet Printer	Canon	£175.08	£149
BJC-610 Colour Bubble Jet Printer	Canon	£421.83	£325
BJC-6xx Ink Cartridge, Black High Capacity	Canon	£116.10	£12
BJC-6xx Ink Cartridge, Cyan	Canon	£117.50	£10
BJC-6xx Ink Cartridge, Magenta	Canon	£117.50	£10
BJC-6xx Ink Cartridge, Yellow	Canon	£117.50	£10

BJC-210

Colour Bubble Jet Printer	Canon	£233.83	£199
BJC-4xxx Cartridge, Colour	Canon	£47.00	£40
BJC-4xxx Cartridge, Black	Canon	£30.55	£26
BJC-4xxx Ink Tank, Black	Canon	£105.98	£91
BJC-4xxx Ink Tank, Colour	Canon	£25.85	£22
DeskJet 340	HP	£199.75	£170
DeskJet 500 Series / Deskwriter Ink Cartridge, Black high capacity	HP	£24.68	£21
DeskJet 500 Series Tri-chamber Colour Ink Cartridge	HP	£27.03	£23
DeskJet 600	HP	£205.63	£175
DeskJet 660C	HP	£280.63	£239
DeskJet 600 Series Ink Cartridge, Black	HP	£4.88	£21
DeskJet 600 Series Ink Cartridge, Colour	HP	£4.88	£21
DeskJet 870C	HP	£440.63	£375
EP-L Toner Cartridge for LBP-4	Canon	£69.33	£59
EP-S II Toner Cartridge for LBP-8	Canon	£81.08	£69
LaserJet 5L	HP	£393.63	£335

20 months to pay **0% FREE FINANCE!**
Call now for details
HOW TO ORDER

Carriage is free within mainland UK if you pay on ordering.
Cheques should be made payable to Ian Copestake Limited.
You may also pay by credit card, debit card or Switch. We normally make no charge for this, and take no payment until goods are despatched. We need your address as known to the card issuer, the card number and expiry date, and the valid from date and issue number if any.
If you leave an order on our answering machine please include your telephone number, your card details as above, and your calculation of the total payment due.
Official orders are welcome from UK educational and government institutions (invoices are due for payment within 14 days and are subject to carriage and late payment charges).
Prices including VAT are shown in italics, followed by the price excluding VAT: eg "£117.50". Zero-rated items are marked V0. Please pay the amount including VAT unless you are a VAT-registered EC customer outside the UK, in which case please quote your international VAT number. Ours is GB 595 7258 84.
Overseas carriage: If you are paying by credit card we will add airmail and insurance at cost. Otherwise please add £6 (Europe) or at least £12 (elsewhere) for each software item and send a pounds sterling bank draft payable at a London clearing bank, or Eurocheques for not more than £100 each.

Scantastic Deals!

From the leader in Acorn scanning.

NEW
MODEL
GT5000



Epson GT5000, GT8500, and GT9000

A range of professional quality A4 colour flat bed scanners. Packages are supplied complete with scanner, our highly acclaimed ProImage software, leads and manual.

- GT5000, 24 bit colour, 300 dpi (optical) resolution, connects directly to bidirectional parallel port.
- GT8500, 30 bit colour, 400 dpi (optical) resolution, connects directly to bidirectional parallel port or suitable SCSI interface.
- GT9000, 30 bit colour, 600 dpi (optical) resolution, connects directly to bidirectional parallel port or suitable SCSI interface.

NEW
STITCHING
PACKAGE



Primax ColourMobile

A quality 24 bit colour motorised scanner, with resolution up to 400 dpi (interpolated). Automatically scans flat images and can be used as a hand scanner for books. Colour scanning has never been so affordable.

Optional stitching package includes scanning guide and software to allow larger images to be scanned in strips.

Connects directly to bidirectional parallel port, and provides through connection for printers, dongles and parallel port CD-ROM drives.

- ColourMobile package - £242.05 inclusive.
- Stitching package - £29.38 inclusive.

NEW LOW
PRICE



Logitech ScanMan Colour

A high quality 24 bit colour hand scanner, with resolution up to 400 dpi (interpolated). Unlike traditional greyscale hand scanners, the ScanMan Colour is fast, accurate and easy to use.

Package includes scanner, single width expansion card, our ProImage scanning software, leads and manual.

- ScanMan Colour package - £298.45 inclusive.

Packages prices are inclusive of carriage (UK mainland) and 17.5% VAT.

Please 'phone for latest pricing details on Epson GT series scanners.

For the Complete Picture...



Irlam Instruments Ltd, Brunel Institute for Bioengineering, Brunel University, Uxbridge, Middlesex, UB8 3PH. Tel/Fax 01895 811401. Email: sales@irlam.co.uk

Please check suitability before ordering. You must have RISC OS 3.10 or later, a hard disc and 2Mb RAM minimum (4Mb recommended). All hardware products come with full 1 years guarantee. E & OE.





New Psion organisers, will Acorn follow?

PSION has introduced two new pocket computers, the Siena and the Series 3c. This news might get some optimists in the Acorn world prematurely excited. Unfortunately it's a bit early to expect StrongARM-based Psions and, so far, there is no detailed confirmation from Acorn that the new Psions will receive an Acorn Pocket Book badge. However, Acorn has mentioned in passing that it will be increasing the current Pocket Book range, which is based on the Psion Series 3a.



Siena – smaller and cheaper

THE SIENA is a smaller, lighter (183g) and cheaper alternative to the original Series 3a while the new Series 3c is much like its predecessor but adds an infra-red communication facility and has better facilities for linking up to other computers via modem or mobile phone.

A completely new design, the Psion Siena is slightly slimmer than the familiar 3a/3c case in all dimensions. It's also a fair bit lighter and feels quite at home in a shirt pocket. An unusual catch hides the battery compartment and infra-red IrDA-compliant transmitter as well as performing the function of opening and closing the clam-shell case. With the infra-red link you can beam files to and from other Sienas or the new Psion 3c without the need for a clumsy cable. An increasing number of printers support IrDA wireless printing too.

There are some sacrifices in the Siena – the screen is just half the width of a Series 3a/3c, however it retains the same dots per inch resolution, so although you only see half as much of the screen, it's still quite clear, though not back-lit. To the right of the off-set screen is a

conventionally arranged calculator keypad. You can toggle between a standard calculator (with virtual till-roll which can be scrolled back to see recent calculations) or the superb, if unusual, scrolling algebraic calculator, which has been a standard feature of Psion Series 3 models from day one.

The keyboard and application touch keys look familiar and though the keyboard is

With the infra-red link you can beam files to and from other Sienas or the new Psion 3c without the need for a clumsy cable

more crowded, it doesn't seem to be any less easy to use. Gone is the telephone dialler function and the sound function no longer has a record option. Sounds are synthesised rather than sampled, so they sound a little tinny. Both the new Psions have a new external cable

socket, but the Siena can't, according to Psion, be connected to either a modem or a mobile phone. There seems to be some indication that this was a deliberate ploy by Psion to avoid confusing the market and compromising the new 3c models.

Two memory sizes are available for the Siena – 512K and 1Mb. No SSD (solid state disc) slots are included, though the manual refers to an external SSD drive. All the main Series 3 built-in applications remain and the Data function now has a list view. Psion will be marketing a range of trendy alternative cases with a selection of weird and wonderful colours and designs. Smaller AAA batteries are used, but at least 40 hours of normal operation are promised by Psion.

The two Siena models are priced £169.95 inc VAT for the 512K version and £229.95 inc VAT for the 1Mb version. Psion hopes those who have been put off by the higher price of 3a models in the past will now be tempted by the Siena. The lower price point will also be welcomed by schools, should we see a Siena Pocket Book.

Million-seller made better

PSION has concentrated on evolutionary enhancements to the tried and tested Series 3a and come up with the Series 3c – not sure what happened to 3b. The electronics work at a lower voltage and battery life has increased to around 80 hours of typical use. Like the Siena there is a new IrDA-compliant infra-red link and the new comms port is also featured. The serial communications link now operates at 57600 bits per second, three times faster than before and there is a new Psion

14.4Kbps 3Link modem to match.

The Series 3c supports OVAL, Psion's latest programming language which is compatible with Microsoft Visual Basic. Among the various tweaks to the built-in software applications there is a list view for the database, a 'busy' view for the Agenda diary/scheduler and the sound recorder now has an editing function. There is also a notepad function for convenient 'jotting' and a revised file manager.

Psion is promising a full suite

of Internet applications, including Internet e-mail and a Web browser. One criticism of the original Series 3 design was its lack of support for industry-standard PCMCIA mini-card devices, like modems, for example. This has been answered via an optional PCMCIA drive which connects to the new expansion port. The two SSD drive bays are, however, retained.

Recommended prices for the 1Mb and 2Mb versions of the Series 3c, £339.95 and £399.95

respectively inc VAT, are the same as the earlier corresponding 3a models before their recent price cut. Now that Psion's new Siena has been priced from less than half its up-market sibling, one could speculate that Acorn will be examining its Siena Pocket Book options with some enthusiasm. The old Psion Series 3a range will continue on sale for some months, but a Psion representative hinted to *Acorn User* that the 3a would be phased out fairly soon.



ARM unveils 810 chip

ARM Ltd has shown its 810 processor for the first time at the recent Hot Chips 96 semiconductor show. The ARM810 has been somewhat over-shadowed by the ultra-fast StrongARM developed by Digital. Delivering 80mips (million instructions per second) the StrongARM is nearly three times faster than the ARM810.

Acorn has dropped plans to introduce ARM810 versions of the Risc PC in favour of the StrongARM. However, the 810 has a bright future as a higher performance alter-

native to the original 600 and 700-series ARM processors which have been acclaimed in power-sensitive applications, like portable devices. ARM revealed that the 810 consumes 500mW power at 3.3V, compared to 72mW at 3.3V for a basic ARM7 core and 900mW at 3.3V for the StrongARM.

The ARM 810 has an 8K cache and ARM says the design is optimised for cost-sensitive applications like digital televisions, PDAs (personal digital assistants) and NCs

(network computers). The ARM810 features a five-stage pipeline which enables each instruction to be executed over more cycles, reducing the amount of work done at each stage and allowing higher clock rates. Although the higher speed increases the chip size and power consumption, performance is doubled compared to the ARM710, and ARM points out that its industry-leading mips/Watt and mips/mm2 ratios are preserved. ARM Limited's web site is at: <http://www.arm.com/>

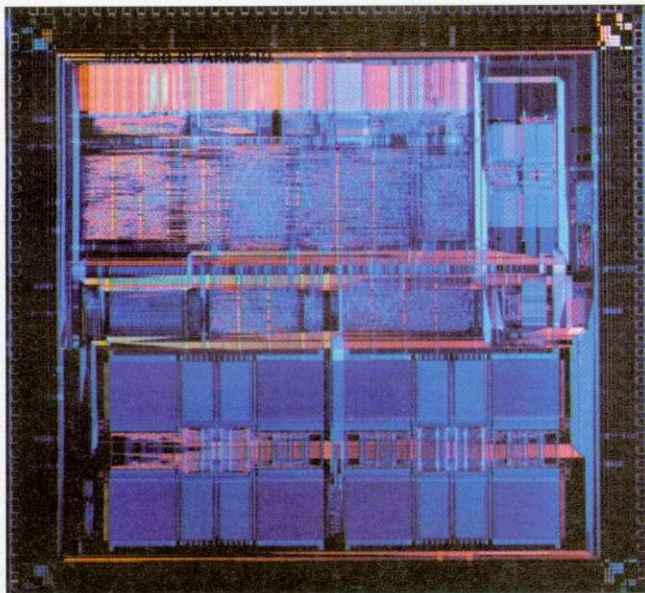

Psion StrongARM?

PSION will do nothing more than make vague hints about their next-generation technology. They won't even confirm forthcoming products will be ARM-powered, even though they are openly working with Digital on porting their Epos operating system development environment to StrongARM.

One thing a Psion spokesman seemed to rule out to *Acorn User* was the adoption of handwriting recognition. Instead, voice recognition will be the technology Psion will concentrate on, which ties in nicely with

their mobile telephony aspirations. Co-incidentally, Motorola has revealed that it is working on speech processing developments involving ARM processors as well.

Psion sold 163,500 organisers in 1995, capturing a leading 32.7 per cent of the world market, according to Forrester Research figures. A million Series 3 organisers have been sold since their launch over five years ago. Nearly 20,000 of those are Acorn-badged Pocket Books. Psion PLC, tel: 0171 262 5580, fax: 0171 258 7340

StrongARM benchmarks

THERE has been considerable debate on the Internet newsgroups regarding the relative performance rating of the StrongARM processor. This comes after a benchmark list was published on the Internet, placing the StrongARM inside the top-ten of processors tested, ahead of Intel Pentiums, and only beaten by super-RISC chips like the awesome DEC Alphas.

StrongARM is, indeed, an amazing chip, but its capabilities have to be put into perspective. The Dhrystone benchmarks quoted by the performance ranking, which was the subject of the debate, only measures integer processing performance and even then, the benchmark can be affected by the quality of the C compiler used.

Also, the StrongARM is a 32-bit chip compared to the 64-bit architectures of most super-RISC chips and even the Pentium CISC design. The efficiency of the overall system is not tested as Dhrystone benchmarks usually execute entirely within the host processor's cache memory. Nevertheless, Acorn quotes a figure of 204MIPS at 200MHz for StrongARM. The fastest chip on the list is 266MHz Alpha

returning almost 367mips.

Our very own loose performance 'calculation' suggests a 30MHz ARM610 is equivalent to an Intel 486 DX2/66. An Intel Pentium 75 usually benchmarks in a system twice as fast as a 486 DX2/66. If we argue that a 40MHz ARM710 is about 40 per cent faster than a 30MHz ARM610 (benchmarked in a Risc PC) and a StrongARM is five times faster than a 40MHz ARM710, then we can work out that a StrongARM is about seven times faster than a 30MHz ARM610.

If a 30MHz ARM 610 represents half the speed of a Pentium 75 - say a Pentium 37.5, a StrongARM should equate to seven times the performance of a Pentium 37.5, or a Pentium 262.5. Ah, so a StrongARM out-performs a Pentium 200, which is the fastest available Pentium Intel yet sells. That's a very dodgy statement indeed but fun to wind up the Wintel brigade.

The famous Internet processor benchmark list is proof of its own fallibility - it lists different Pentium 90 systems as returning MIPS results of between 45 and 124, while a lowly Pentium 66 recorded over 100MIPS. The same rule applies to any benchmarking program - lies, damned lies and benchmark results.

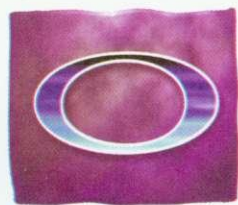

OVATION Pro

(THE PROFESSIONAL DESKTOP PUBLISHER)

Ovation Pro combines fast responsive word processing with state-of-the-art page layout features to deliver the ultimate desktop publishing system. Packed with a staggering range of professional features—many available on the Acorn platform for the first time—*Ovation Pro* opens up a whole new world of document design. At last you can flow text inside and outside irregular frames or rotate them to any angle—in both cases the text remaining fully editable. Even with such vast range of features *Ovation Pro* is still easy to use, thanks to a superb user interface that makes the software easy to learn and instinctive to use.

(SUPERB FACILITIES INCLUDE:)

- ◆ Definable Button Bar
- ◆ Multi-step Undo and Redo
- ◆ Named colour system
- ◆ Definable width Pasteboard
- ◆ Frames with skew and rounded corners
- ◆ Straight and curved line drawing
- ◆ Easy-to-use active master pages
- ◆ Reads Ovation, RTF, DDF, Artworks
- ◆ Irregular frames with Bézier curves
- ◆ Drag & Drop for text and objects
- ◆ Definable colour charts
- ◆ Justification and letter spacing
- ◆ Vertical justification
- ◆ Autoflow around irregular graphics
- ◆ Context sensitive info palette
- ◆ Macro handling and script language
- ◆ Rotated text frames with editable text
- ◆ Drag and drop between documents
- ◆ Automatic drop caps
- ◆ Multi-column frames
- ◆ Frame borders and drop shadows
- ◆ Show invisibles
- ◆ !Chars and single-shift font change
- ◆ Customisable with saveable changes

(FREE UPDATE)

A free update will be sent to all registered users, offering more advanced features such as full-colour and spot colour separations, image processing, auto paragraph numbering and 'local OPI' for handling large graphics bigger than the memory size.

(THE EXTENDABLE DTP SYSTEM)

Ovation Pro has advanced expansion capabilities using extension modules called Applets. These allow new features to be added without the need to upgrade the main application. Simple extensions may also be written using the integrated script language. A range of extension applets and scripts are planned for the future.

(THE OVATION PRO PACKAGE)

Ovation Pro is supplied with a 300-page reference manual, separate tutorial, reference card, Bubble Help, Desktop Thesaurus, 50 outlines fonts (from EFF, Acorn and Beebug) and a sample selection of clipart from DEC_data. Full colour brochure available on request.

(OVATION PRO costs £193.88)

Upgrade from Ovation (bought before 27/10/95) £92.83

Upgrade from Ovation or other DTP* £116.33

*includes impression, EasiWriter, PenDown+ and Advance

Other upgrades and site licences available – please phone for details

To upgrade you should return your original disc with payment (discs will be returned).

Prices include VAT but please add £3.50 carriage

Airmail will be charged at cost to overseas customers

BEEBUG

Beebug Ltd.

117 Hatfield Road, St. Albans, Herts. AL1 4JS

Tel: +44 (0) 1727 840303 Fax: +44 (0) 1727 860263 Email: sales@beebug.co.uk



Introducing the new

Power-tec 4x4 CD Multi-Changer

from Alsystems

ONLY
£125



Actual Size.

THE LATEST ADDITION TO THE POWER-TEC RANGE IS HERE

The Power-tec 4x4 is a fast quad speed ATAPI drive from NEC with a quality built-in multi-changer mechanism which allows you to insert four CDs simultaneously into the drive. The Power-tec software positions 4 CD icons on the icon bar allowing you to access different information from any one at any time. For example: Import some photos from one CD into your document, then access some clip art from another all at the click of a mouse. No need to keep fiddling about swapping CDs every time you want to access different information.

The 4x4 will mount easily into your RiscPC's spare 5 $\frac{3}{4}$ inch bay, has been thoroughly tested with StrongARM and Risc OS 3.7, and is fully compatible with PhotoCD, MPEG and audio CDs allowing you to get the most from your collection.

The Power-tec 4x4 CD Multi-Changer is available only on the Alsystems Stand (68) at Acorn World and costs just £125 exc VAT. Bring along your RiscPC for free fitting by our experienced technicians while you wait.

email: sales@alsys.demon.co.uk

NB: All prices exclude VAT and carriage. E&OE
Please call Alsystems on 01420 561111 for more details
Alsystems, 47 Winchester Road, Four Marks, Alton, Hampshire. GU34 5HG.

Power-tec
the power to perform



Avery ink-jet labels

LAST month it was labels for CD-ROM discs, this month it's labels for ink-jet printers. Avery Dennison's latest offering is more accurately described as labels made from specially coated paper designed specifically for ink-jet printers.

The special coating prevents the blurring or feathering of the ink-jet image caused by paper fibres on the surface of the sheet. Supplied samples of Avery's new ink-jet labels certainly back up the company's claims, with sharp graphics

and well-saturated colours. Specially coated paper for ink-jet printers has been available for almost as long as ink-jet printers have been on sale, so it's surprising to learn that Avery is the first label supplier to use special ink-jet paper for its label stock. Sizes available include 8, 14, 16 and 21 labels per A4 sheet. 25-sheet packs have a recommended price of £22.99 and you're covered by a money-back guarantee.

Avery Office Label, tel: 01628 764 000, fax: 01628 764 110.



Voyager voice-mail

VOYAGER, the Internet communications suite supplied by Argonet to its Internet subscribers has been enhanced with the addition of a voice-mail function designed to work with the company's recommended modem, the USR Sportster Vi.

The voice-mail facility, which effectively enables the modem to function like a digital answering machine, using your computer's hard disc as a recording medium, was developed in conjunction with USR and is being made available free to Argonet subscribers. It's possible that the voice-mail facility may become a commercial product in its own right at some time in the future.

Meanwhile, the group of companies including Argonet, VTI and Eclipse are now listed on the stock market. If you are interested in purchasing shares in VTI Holdings PLC, a prospectus is now available from the company on tel: 01243 531 194, fax: 01243 531196, e-mail: vti@argonet.co.uk



Tektronix Phases in colour printers

TEKTRONIX has announced new solid-ink, or phase change colour ink-jet printers and has celebrated the news by offering buyers free supplies of black ink. The new Phaser 350 replaces the successful 340 model which was launched in March last year. The PostScript Level II printer can now operate at up to six pages per minute instead of four and the printer can be linked via Internet protocols to a suitable network so that printer status and settings can be remotely examined and adjusted using a standard Web browser.

Phaser solid ink printers use a wax-based dye which has to be melted and then jetted via piezo-electric



nozzles onto the print medium. As the ink is a wax, it can print on almost any material that fits safely through the printer mechanism, including some fabrics.

Tektronix also claims that, like for like, the Phaser 350 represents a 25 per cent cost saving over the outgoing 340 model. Phaser 350 prices were not actually available at press time, however. Tektronix has also announced the Phaser 300X, an A3 format printer which replaces the Phaser IIPXi/300i. The Phaser 300X is faster than its predecessor and has improved proofing facilities.

It is priced £7,495 + VAT. Tektronix, tel: (01628) 403 640, fax: (01628) 403 653.



Xemplar catalogue

XEMPLAR Education, the joint venture between Acorn and Apple targeting the education market, has launched its first autumn catalogue. The company says the new catalogue covers solutions for pre-school, primary and secondary schools and colleges and also includes partnerships with other educational resource suppliers apart from Acorn and Apple.

Brendan O'Sullivan, Xemplar Education's managing director, commented: "since its formation, Xemplar Education has been totally focused on supplying complete solutions for the classroom which enable and assist teachers in their teaching. We have developed this focus by taking a

closer look at the needs of teachers throughout pre-school, nursery, primary and secondary schools - markets we know better than any other company. We then designed solutions which incorporate the particular resources required to teach in the given subject area." O'Sullivan added: "Supplying the educational market is no longer simply about selling computers to school, it is about providing everything needed to make IT most effective in the classroom. Our new catalogue presents Xemplar's commitment to this approach."

Primary schools are being offered primary Classroom Resource Packs,

which include selections from a broad range of educational software and book, audio and video tape suppliers, as well as hardware from either Acorn or Apple. There is a similar formula for Xemplar Toolbox products, each of which is supplied with software, hardware and other resources tailored for various curriculum needs.

The new Autumn'96 catalogue is being mailed to over 40,000 teachers and IT co-ordinators around the country, but if you don't receive one you can obtain one free of charge from Xemplar direct via tel: (01223) 724262, fax: (01223) 724300, e-mail: info@xemplar.co.uk

Great new monitors

TWO leading monitor makers have interesting news this month. iiyama, which has developed a reputation for producing excellent budget-priced displays, has reduced the prices of its 17 and 21 inch monitor ranges. Unfortunately, for some reason our press release contained US\$ prices, but for example, the popular Vision Master 17 has been reduced from £549 + VAT to £529 + VAT.

At the other end of the cost and features scale, Taxan has launched a futuristic LCD flat panel LCD which is aimed at replacing conventional and bulky CRT (cathode-ray tube) monitors. The new top of the range Taxan Crystalvision 650 has an active-matrix thin film transistor (TFT) display with a 14.5 inch visible diagonal and a pixel resolution of 1024x768. This compares with some conventional 17 inch monitors which can measure up to a mere 14.8 inches of true visible diagonal.

As the display is truly flat, there are no geometric aberrations to worry about and colours will be consistent too. The only concession to conventional technology that the Crystalvision 650 makes, is the number of displayable colours, which is 262 maximum

compared to most quality CRT monitors' ability to render 16 million plus. One advance Taxan claim over most of their flat panel rivals is that you don't need a separate interface card via which the monitor is connected.

The Crystalvision 650 has its own analogue to digital converter so it can be plugged into any industry standard VGA connector, including those on later Acorn computers. Multiple scanning means that 800x600 and 640x480 resolutions can also be supported, plus there is VESA DPMS power-saving too. But the

biggest feature this monitor has is its cool looks - it really wouldn't look out of place on Jean-Luc Picard's ready-room table.

Back down to earth, while iiyama are shaving the pounds off the prices of its conventional 17 inch monitors and rapidly approaching the £500 mark, you could buy almost six iiyamas for the price of one Crystalvision 650, which is priced £2999. Taxan say that dealers will almost certainly discount that price, however. iiyama Europe, tel: (01923) 219050, fax: (01923) 219048, Taxan (Europe) Ltd, tel: (01344) 484 646, fax: (01344) 50974.



Welsh Bible software

TAVISTOCK-based ExplAN Computers Ltd has announced a Welsh language version of its Holy Bible software, which is called *Y Beibl Cymraeg Newydd* (New Welsh Bible). The software is aimed at Welsh-speaking schools and

ministers who require a version of the Welsh Bible which can be electronically searched and cross-referenced. The first edition supplied also contains the Apocrypha.

The rich-format Welsh text is licensed from the British

and Foreign Bible society and has been internally re-numbered to the Hebrew standard, so it can correctly auto-track with other Bible versions having alternative book and verse ordering. *The New Welsh Bible Pack* is

priced £25 + VAT for a single-user licence and requires a Base Pack if you don't have one already. For more information, contact ExplAN on tel: (01822) 613868, fax: (01822) 610868 or e-mail: explain@explain.demon.co.uk

SAVE UP TO £200!
brochure price (VAT inclusive)

AUTUMN OFFER!
Available now!

SCANNER plus SCSI Interface

SCSI II INTERFACES from £66

(when bought with Scanner):

A3000, A3010, A3020, A4000 **£66** (£77.55)
A310, A400, A540, A5000, RiscPC, A7000 **£72** (£84.60)

Castle Technology's plug-&-play software allows up to 7 SCSI peripherals to be connected. Free software includes !Setup (SCSI), PhotoView, CDPlayer, and !Change FS.

*Backplane may be required

Buy one of our top quality Scanflat A4 flatbed scanners and start to realise the true power of your Acorn. Save time: scan in photos, drawings or logos etc; create your own full colour pictorial greetings cards, newsletters or reports; or use it to enhance your multimedia programmes.

- ◆ Special Offer SCSI interface from £66 (£77.55 inc VAT) makes installation easy
- ◆ Line art, grey or 24-bit colour modes
- ◆ Pre-scan colour/brightness control
- ◆ Free ImageMaster Software & TWAIN driver
- ◆ Full 1 year guarantee

Scanflat 600

Use the Scanflat range to reproduce beautiful photos like this:



Framlingham Castle, once one of the strongest fortresses in Britain

Price in brackets includes delivery and VAT

	Brochure Price	Offer Price
Scanflat 600 (600dpi)	£449 (£539.33)	£299 (£363.08)
Scanflat 800 (800dpi)	£549 (£656.83)	£399 (£480.58)
Scanflat 1200 (1200dpi)	£699 (£833.08)	£549 (£656.83)

Delivery £10 per scanner. 2% credit card charge may apply

ORDER NOW!

CALL 01728 621222

or order by FAX ON 01728 621179

Delivery £10 (£11.75 inc VAT) per order.
Prices exclude VAT unless otherwise indicated.
Cheques (allow 5 working days to clear), debit cards (Switch & Delta), credit cards (2% charge may apply), and educational orders accepted.
All trademarks acknowledged. E&OE

Castle Technology Ore Trading Estate Woodbridge Road
Framlingham Suffolk IP13 9LL
e-mail: sales@castle-technology.co.uk
Web: http://www.castle-technology.co.uk

SPECIAL PURCHASE

120Mb and 240Mb Hard Drives

for A3020 / A3010 / A3000 (Risc OS 3.1 required)

	120Mb		240Mb	
	ex VAT	inc delivery & VAT	ex VAT	inc delivery & VAT
A3020	£90.00	£117.50	£120.00	£152.75
A3010 incl Interface	£129.00	£163.33	£159.00	£198.58
A3000 incl Interface	£129.00	£163.33	£159.00	£198.58

FROM £90
inc delivery & VAT
incl fixing kit

A further unexpected bulk purchase allows this unbeatable offer to be repeated - order NOW to avoid disappointment!

Get one of our Special Offer hard drives and dramatically increase the power of your Acorn. Fit it yourself - no special knowledge is required and no extra parts are needed. Just connect and go!

- ◆ Easy to fit
- ◆ Uses Risc OS 3.1 for full compatibility
- ◆ All drives formatted and soak tested
- ◆ Full 1 year guarantee
- ◆ 500Mb also available

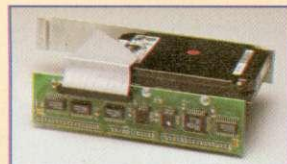

AN EXPANDABLE SCSI EXTERNAL CD-ROM

for any Acorn computer (except A4)

for only **£99**

(£128.08 inc DELIVERY & VAT)

Available now!
Call 01728 621222

- 300 Kb/sec CD-ROM
- Tray loading CD
- Volume control
- Headphone socket
- *Spare slot (for other SCSI devices)
- SCSI cable
- SCSI terminator
- SCSI ID selector
- Daisychain PSU
- Whisper-quiet fan



Front



Back

Combo Case with CD-ROM

The unique expandability of SCSI makes it so easy to install extra SCSI hardware, and Castle Technology is delighted to be able to make this once-in-a-lifetime CD-ROM offer. Make use of the wealth of CD-ROM material available as well as playing audio CDs direct from your computer.

- Own internal PSU
- SCSI in & expansion
- Phono output (to hi-fi etc)

Replay, Audio player, PhotoCD etc compatible

SCSI II INTERFACES from £66

(when bought with CD-ROM):

A3000, A3010, A3020, A4000 **£66** (£77.55 inc VAT)
A310, A400, A540, A5000, RiscPC, A7000 **£72** (£84.60 inc VAT)

Castle Technology's plug-&-play software allows up to 7 SCSI peripherals to be connected. Free software includes !Setup (SCSI), PhotoView, CDPlayer, and !Change FS.

*Backplane may be required

*Use spare slot for other SCSI devices

Hard drives up to 2Gb from £39 (100Mb), Panasonic PD (600Mb optical + CD), SyQuest, Jazz, Zip etc. removable drives.

Faster CD-ROM drives are available as an option - Call for details



Optima returns

Spotted at the recent ECTS'96 leisure computing trade show was none other than an updated Eidos *Optima* digital video editing suite, now based on a Risc PC instead of an A540 and sporting much improved video resolution and clarity.

The original Eidos *Optima* package sold in small numbers to enthusiastic film producers, including the BBC, for use as a non-linear video editing system. You did your edits on digitised footage and then programmed the finalised edit instructions into a vastly expensive linear editing system to finish the job.

The problem with the old *Optima*

system was that, although it had every fade, wipe and special effect you could want, its display quality was poor. Enlightened film editors didn't mind at all, but they were in the minority and the product was shelved a couple of years ago. Then the Risc PC came along and Eidos used the extra processing power provided to improve the digital sampling quality. It's now almost VHS quality, according to our spies and more than acceptable for semi-professional and professional use.

Apparently, Eidos are eyeing up a sizeable contract being offered by the BBC once again. The final ingredient to the re-

born *Optima* package will be the StrongARM processor, enabling a Risc PC to do quality real-time digitising and compression at a price which could stun the competition.

Eidos, the company, has moved on remarkably since its inception about five years ago. The company now owns the majority of the UK games software producers, but company co-founder Stephen Streater still has time for the *Optima* project. Hopefully, some of the technology Eidos has developed recently will find its way into Risc PCs of non-professionals too.

!LazyPrint updated

!LAZYPRINT, the utility published on the *Acorn User* cover disc in June, has been enhanced and has now reached version 2.10. Author David Crennell tells us that enhancements include changes to fonts, underlined text and StrongARM compati-

bility work has been completed. There are also a few bug fixes as well.

David says that users of Hewlett-Packard printers who are interested in obtaining the latest version can do so by becoming registered users. All you have to do is read the

instructions in the ReadMe file contained in the version of *!LazyPrint* contained in the June cover disc or contact 'Fortran Friends' on tel: (01235) 834357 for further information. David can also be contacted via e-mail at: crenell@v2.rl.ac.uk

Simply Simtec

Continuing the tradition of making user-expandable memory modules, Simtec has just launched a new VRAM upgrade. This comes in two guises, a user-expandable 1Mb board and a 2Mb board. The 1Mb version has the unique feature of having empty sockets into which additional chips can be plugged within a few minutes to give 2Mb. This avoids the current inconvenience of sending a card away to have the extra chips soldered on.

Also as part of the development of the multi-processor, Simtec will be demonstrating the new multi-threading extension for RISC OS at Acorn World. As well as simplifying software design, it will enable new software to run on any machine from an A3000 to Multiple ARM Risc-PCs automatically taking advantage of any extra processors present. More details will be available at the show.

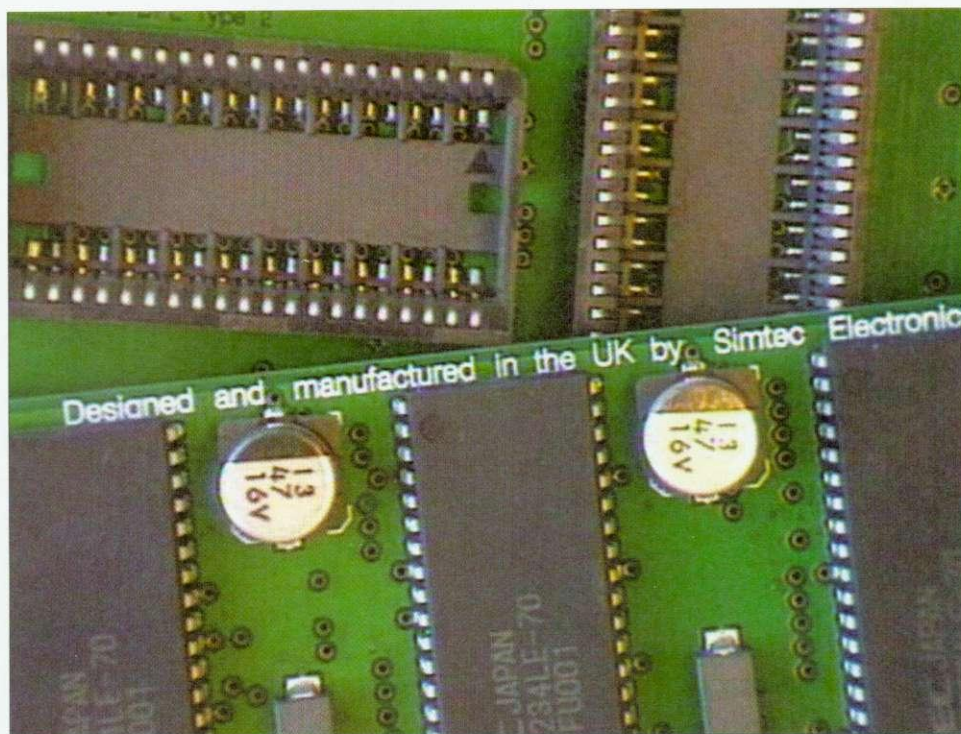

WILD AND WACKY STORIES FOR CHILDREN AND ADULTS

Ridiculous RHYMES

Written & illustrated by
Tony De Saulles

Narrated by TV's
Tony Robinson

Enhanced version available
on:

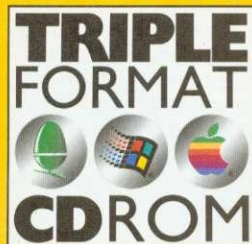

Age 7+ years

£50-53 inc P&P and VAT

Available for WINDOWS, APPLE MAC or ACORN RISC OS on TRIPLE FORMAT CD ROM or Disc.

Disc users please specify which version you require.

CONTACT US NOW FOR A DEMO VERSION OF THE ABOVE PRODUCT

BRINGING CHILDREN'S FICTION TO LIFE IN A WAY NO ORDINARY BOOK CAN

Rusty Dreamer

by **Mike Matson**

- Three different reading levels
- Exciting plot that appeals to all ages
- Professional narration
- Innovative video animation
- Hundreds of high quality pictures
- Scrolling map with over 130 photographs
- Picture galleries featuring a variety of subjects to stimulate creative work
- Extensive resource materials

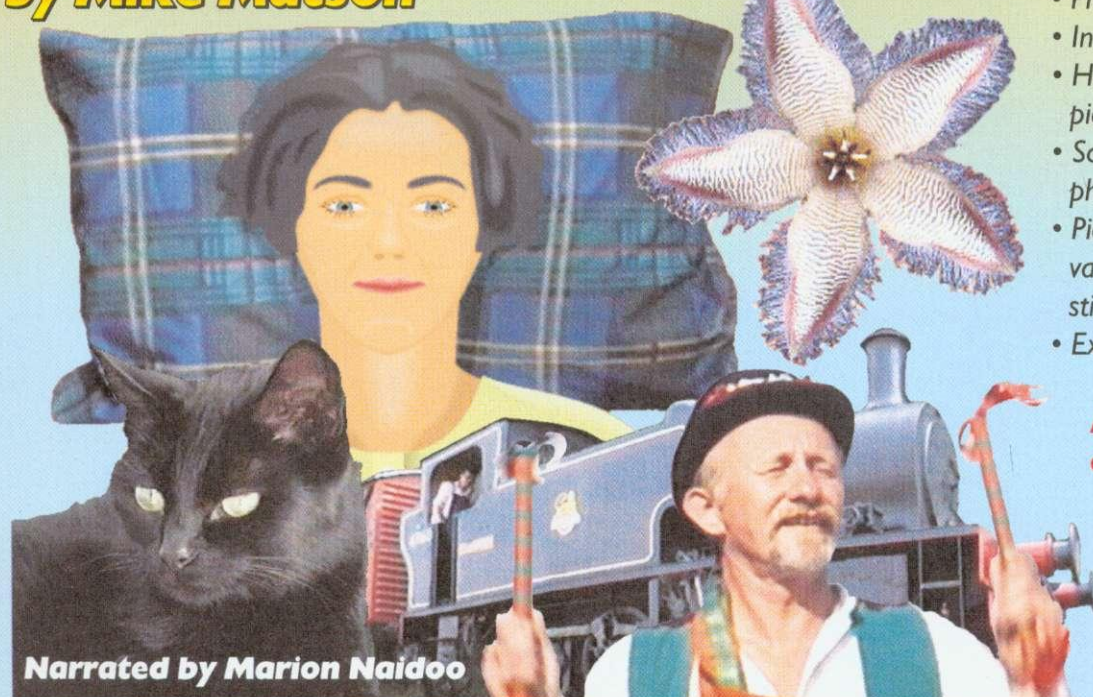

Narrated by **Marion Naidoo**

Available exclusively
on:

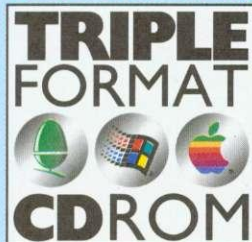

Age 8 - 14 years

For WINDOWS, APPLE MAC or ACORN RISC OS on CD ROM

£62-22 inc P&P and VAT



Don't miss the Sherston Online Catalogue at <http://www.sherston.com>
or contact us now for a FREE copy of our 24 page colour brochure

Sherston Software Limited, Angel House, Sherston, Malmesbury, Wiltshire SN16 0LH

Tel: 01666 840433 Fax: 01666 840048 e-mail: sales@sherston.co.uk

CD-ROM Drives

Multi-Session, PhotoCD, CD-DA, White & Green Book compatible. SCSI drives require SCSI card with CDFS >2.20
Carriage: a=£2, b=£6, c=£8
Internal ATAPI CD-ROM Drives
Panasonic 8xCD ATAPI (Tray) £100b
Cable & Fitting Kit £10
Above drives are compatible with RiscPC/A7000 only.

Internal SCSI Drives (Tray)
Sony 2x CD SCSI £75ms £80b
Pioneer 4.4x CD SCSI £150ms £190b
PCW Verdict - 'It's extremely quick, and a bargain.'
Panasonic 6x CD SCSI £140ms £199b

External SCSI CD-ROM Drives
Sony 2x CD SCSI £275ms £135c
Pioneer 4.4x CD SCSI £150ms £260c
Panasonic 6x CD SCSI £140ms £270c

For SCSI interfaces refer to Hard Disc section adjacent.

Hard Discs

Carriage: a=£2, b=£6, c=£8
IDE 3 1/2" Bare Hard Drives
Connor 635Mb 12ms £135b
Connor 850Mb 12ms £Call
Connor 1.27Gb £225b
For A3000/A3010 hard discs see Hard Card section below.

SCSI 3 1/2" Bare Hard Drives
Quantum 1.28Gb 12ms £255b
Quantum 2Gb £450b

Syquest Removable SCSI Drives
All following Syquest Drives include a Cartridge.
EZ135Mb Internal £120c | 1105Mb Internal £109b
EZ135Mb Ext £120c | EZ135Mb Cartr. £20a
270Mb Internal £165b | 105Mb Cartridge £29a
270Mb External £215c | 270Mb Cartridge £50a

Hard Disc Interfaces/Accessories
IDE interface £65b | 50-pin SCSI Cble£10a
Morley Uncached £160b | 25P-50C SCSI Cbl£110a
Morley Cached £160b | SCSI-2-50C Cable £24a
Curmana SCSI II £195b | SCSI 2-25D cable £20a
PowerTec SCSI2 £195b | 50IDE-4-way SCSI£15a
External case/psu £90c | 2nd IDE Drive Kit £15a

zip/jaz Drives

* zip & jaz Drives work just like hard drives except they are removable, letting you instantly access files and applications.
* zip drives use 100Mb capacity discs & jaz drives use 540Mb/1Gb discs allowing any number of discs giving unlimited capacity.
* The drives are fast. Data transfer speeds around 1Mb/s for zip drives & >2.3Mb/s for jaz drives - ideal to backup your hard drive.
* Each drive comes with 1 year warranty and a starter disc.
* These drives require a SCSI card that is suitable for removable devices.

Internal zip drive (5 1/4") £155b
External zip drive £155b
Single 100Mb zip Cartridge £15a
Pack of 5 zip Cartridges £65b
Internal 1Gb jaz drive (3 1/2") £375b
External 1Gb jaz drive £460b
Single 540Mb jaz cartridge £Call
Single 1Gb jaz cartridge £110a

TopicArt

TopicArtCD1 £30a
This CD-ROM Contains over 2000 ClipArt files, each in Draw, ArtWorks & EPS formats
+ Replay Movies & demos

Floppy discs £8a each
Single disc clipart containing approx. 50 high quality draw format clip art images on each disc, on a single subject. Comes with mmo reference sheet. 20 subjects are available now. Please specify when ordering. Site licence is included.

- | | |
|--------------------|--------------------------|
| 1 General | 11 Tools |
| 2 Transport | 12 Animals/GB |
| 3 Costumes | 13 Chemical Hazard Signs |
| 4 Entertainment | 14 Fire/Emergency Signs |
| 5 Bugs 2 Slugs | 15 Hazard Signs |
| 6 Road Signs | 16 Safety Signs |
| 7 Sports Equipment | 17 Xmas1 |
| 8 Sports Figures | 18 Xmas2 |
| 9 Dinosaurs | 19 Xmas3 |
| 10 Symbols | 20 Xmas4 |

RiscPC Computers

All Acorn computers include 1yr on-site maintenance. 3yr On-site is available. Carriage included on computer systems. For PC Cards see PC Card section below. Please note that a backplane is not fitted to RiscPC600.

With 14" Monitor (AKF60)
RPC600 4MHD540 £1275
RPC600 4MHD540+8xCD £1375
RPC700 5MHD540 £1525
RPC700 5MHD540+8xCD £1625
RPC700 10MHD1Gb £1750
RPC700 10MHD1Gb+8xCD £1850
With 17" Monitor (AKF90)
RPC600 4MHD540 £1675
RPC600 4MHD540+8xCD £1775
RPC700 5MHD540 £1900
RPC700 5MHD540+8xCD £2200
RPC700 10MHD1Gb £2100
RPC700 10MHD1Gb+8xCD £2200
Subtract £50 for iiyama MF-8617E
Add £30 for iiyama MT-9017E

See us at Acorn World, Stand 40 StrongARM

Only £116.33 with RiscPC's
(If purchased before end Dec '96)

20/20 Finance
on Acorn Systems (0%APR)
20% deposit (min) & 20 interest free monthly payments. Min loan £700. Maximum loan £2000. Available subject to status. Ring for details.

A7000 Computers
With 14" Monitor (AKF60)
A7000 4MHD540 £1069
A7000 4MHD540+8xCD £1169

QuickLynk (v1.04) £32a

With 5m Local Cable £39a
With 10m Local Cable £45a
With 20m Local Cable £52a

QuickLynk allows you to access another unattended RiscOS computer remotely using the serial port via modems or locally using a cable to connect the 2 computers. Each computer can be configured to allow access to any attached filing system device eg ADFS, IDE, SCSI, CDFS, etc. Once connected, files can be transferred to/from the remote computer. Other features include password access, auto dialler with phone book and chat mode to send messages to remote computer/user. Transfer rates up to 1.9 kbytes/s can be achieved with older computers, eg. A410, A3000 rising to 11.4 kbytes/s on the RiscPC range. The transfer rate is limited by the speed of the serial port. QuickLynk cannot at present be used directly from programs/ command line. Requires RiscOS 3.10 or greater, ring for details.

QuickTile (v1.03) £29a

QuickTile allows you to create posters from ANY RiscOS application, including Impression. Simply enter the size of poster required & select PRINT from the application! QuickTile does the rest, printing each tile with crop marks and tile references. New features include the facility to print inverted crop marks or no crop marks. QuickTile can only be used with the RiscOS printer Driver or TurboDrivers.

Requires RISCOS 3.10 or later
Return disc to upgrade for £4
Upgrade from Tiler for £18.

Mail Order - 0161-474 0778 (All prices now INCLUDE VAT) The lowest prices without compromise

RiscPC PC Cards

A=Upgrade from ACA42 or bought with RiscPC, B=purchased separately. Carr.: £8
PCCard A B
5x86-100 £350 £579
486DX4-100 £230 £350
486DX2-66 £175 £290
486SX33 N/A £230

RiscPC Upgrades

Carriage: £3 for Sound Cards
StrongARM Upgrade £293c
The £117 StrongARM price is valid for RiscPC systems purchased before end December '96.
YES 16 bit Mozart Card £70
2nd Slice Case £116c
Window '95 CD (Full) £90a

Memory (Carriage £3)

Call for latest prices, they MAY vary.
RiscPC/A7000 SIMMS
4Mb £25 | 8Mb £45
16Mb £89 | 32Mb £180
RiscPC VRAM
1Mb £80 | 2Mb £130
1-2Mb u/g (exchange) £80
Call for details and prices of memory upgrades for other Acorn computers.

Monitors (Carriage £10)

Older computers will require an adaptor £12
AKF50 14" 0.28dp £315
Iiyama MF-8617E 17" £590
High spec FST Tube with 0.26" dot pitch
Iiyama MT-9017E 17" £675
Very High spec Diamondtron tube, 0.25" stripe

Printers (Carriage £8)

Canon BJC-210 £165
Canon BJC-230 £305
Canon BJC-4100 £220
Canon BJC-610 (720dpi) £350
HP LaserJets Printers £Call
Add £47 to above printers for TurboDriver

Networking (Carr. £6)

A30X0 EtherLan 102 £140
Archi EtherLan 514 £140
RPC/A7K EtherLan 602 £120
Add £17 to above prices for Access+.
NetCubes £Call
Easy to install 10baseT Hub pack for up to 6 computers. Ring for more information.

Portable Computers

Carriage: a=£2, b=£6, c=£8
Pocket Book II (256k) £240b
Pocket Book II (1Mb) £320b
Pision 3a (1Mb) (spec.) £295b
Pision 3a (2Mb) £365b
AutoRoute Express UK/Eire £62a
- one of the best packages for the PB/3a
A-Link £49a | PC Serial Link £60a
Parallel Link £29a | Mains Adaptor £15a
128k RAM SSD £45a | 512k RAM SSD £125a
256k Flash SSD £50a | 512k Flash SSD £85a
PB/P3 Games £Calla | PB/II/P3a Games £38a

Hardware Upgrades

2416 Card (1Mb) £450b
FPA for 25MHz ARM3 £67a
iTV TV Tuner & TTX £150b
Joystick I/F (Not RiscPC) £30a
Logitech Mouse (Acorn) £26a
Midi Max Card (CC) £79b
Movie Magic (CC) £275b
Scart Cable (9 or 15 pin) £12ea.
Serial Upgrade (A3000) £22a
25W Speakers (mains) £35b
80W Speakers (mains) £45b

Modems (Carriage £8)

14.4 Voice Sportster £115
33.6 Voice Sportster £180
Modems come with a 25-25 PC wired cable & 25-9 adaptor which may hinder the printer port.
A 9-25 way cables is available at £10. See below. A3k/Archi req. Archi wired cable.
ANT Internet Suite II £115a
ArxFax £32a
Dual Serial Card £104b
9-25 Archi or PC Wired Modern Cable £12ea.
3-way Serial T-Switch (incl. comm. cable) £32

Scanners (Carriage £8)

ScanLight Video 256 £215
Epson Colour Scanners, include iTWAIN & ImageMaster. Bundles include CorelPaint & OCR software suitable for PC Cards.
GTx-5000 Para bundle £425
GTx-5000 SCSI bundle £499
GT-5000 SCSI (bare) £425
GT-8500 bundle £660
GT-8500 (bare) £569
GTx-9000 bundle £Call
GT-9000 (bare) £699

Hard Cards/Multi-Pods

See top for other hard discs. Carriage £8
A3010 Hard Disc Multi-Pod
80Mb+User Port £210
130Mb+User Port £275
160Mb+User Port £320
A3000 IDE Hardcards
80Mb + User Port £170
130Mb + User Port £210
160Mb + User Port £255

Printer Consumables

Carriage: £2 for Cartridges, £8 for Toner
BJ-10 (BC-01) £18 | BJ-200 (BC-02) £19
BJ-210 (BC-05) £28 | BJ-300 (BJI-642) £16
BJC-500 Series | **BJC-400 Series**
BJI-201HCk Black £10 | BCI-21B Black £9
BJI-201bk Black £6 | BCI-21C Colour £17
BJI-201C/MY £8 ea. | BP-20 Fast Black £28
BJC-800 | **HP DeskJets**
BJI-643 Black £18 | Mono £23
BJI-643/MY £23 ea. | Colour £25
Epson Stylus Colour Black £16/Colour £28
Epson Stylus Colour II Black £20/Colour £26
C3903A Toner (LJSP) £64
EP-L Toner (LBP-4/HP LJ11) £64
HP 92274A Toner (HP LJ4L) £60
Swift24 Mono/Colour Ribbon £8/£16

Terms & Carriage

Carriage: To benefit personal callers to our showroom carriage is itemised separately. The carriage indicated is for single items. Please call us for total carriage when ordering more than one item since it is not cumulative.
Terms: All prices include VAT except books. Carriage is not included unless otherwise stated. Carriage charges apply to mainland UK (excluding remote areas, Scottish Highlands, Channel Isles, IOM), elsewhere at cost. Orders MUST be accompanied by a phone number. Prices and spec's subject to change without notification. Goods subject to availability. Goods not offered on trial basis. Restocking fee on non-faulty returns. Official orders welcome from educational institutions, chq with order under £50. E.O.C.

Where to Find Us

Entrance to on-site Car Park via Red Gate WE ARE HERE!
M63 Junction 12 Stockport West
A5145
M63
M63 TO M62/M67
A5145 TO A5
A5145
Glass Pyramid
Brewery/Challenges
WOOD ST
ONE WAY
A560

RiscOS 3.1 Upgrades

Single Rom set £37a
10 Rom sets £290b
Documentation/Discs £22b
Carrier board (A300/A440) £25a
Books (No VAT)
Carriage: a=£2, b=£6, c=£8
Acorn RISCOS 3.1 PM's £99.95c
Acorn Volume 5a PRM £29.95b
Acorn BBC Basic V1 Guide £19.95b
Acorn RiscPC Tech Ref Manual £49.95c
ArtWorks Made Easy (Dabs) £5.00a
Budget DTP (Dabs) £5.00a
C/A Dabhand Guide (Dabs) £5.00b
RiscOS 3 First Steps (Dabs) £5.00a
Wimp Programming for All (Beebug) £10.95a

CD-ROM's (Carriage £2)

CD software for RiscOS
ArtWorks on CD (CC) (Carriage £6) £110
ClipArt CD 1/2 (CC) £21 ea/chk
Dinosaurs (MS) £44
Dune II (Eclipse) £41
Gnanny's Garden CD £32
Guardians of the Greenwood £51
Hutchinsons Encyclopedia £22
Musical Instruments (MS) £44
PB Bears Birthday Party £37
RiscDisc Vol 1 / 2 CD £17 | £20
Simon the Sorcerer CD £41

Applications

Carriage: a=£2, b=£6, c=£8
Advantage (Longman) £52a
ANT Internet Suite (ANT) £115a
ArxFax (David Pilling) £32a
ArWorks (CC) £100b
Blinds (Quantum) £25a
Card Shop (Clares) £23a
Chameleon 2 (4Mation) £39a
Compression (CC) £34a
DataPower (IOTA) £105b
Disc Rescue (Look) £33a
Easy C++ (Beebug) £110a
Eureka v2 (Longman) £110a
FireWorkz Pro (Colton) £164a
Font Directory2 (Look) £33a
Font FX (DataStore) £12a
Graphics Loaders (CC) £50a
Hatchback (4Mation) £38a
HTML Editor 2 (R-Comp) £44a
Image'S2 (Alt Pub) £44a
Image Outliner (IOTA) £44a
Impression Style / Publisher £80 | £135b
Keystroke (Quantum) £33a
MacFS / MacFS Lite (CC) £89 | £53a
Ovation (Beebug) £39b
Ovation Limited Offer (9 copies) £39b
Personal Accounts (Apr) £44a
PhotoDesk (Spacetech) v.1 £185a/v.2 £245b
Prophet (Apricot) £171a
PublishArt2 (SmartDTP) £34a
Resultz (Colton) £89a
Rhapsody (Clares) v3 £297a
S-Base2 Personal / Developer £57 | £115c
ShapeFX (Datastore) £12a

Sibelius 6 / 7 £206b / £92
Slueth2 (Beebug) £11
SparkFS (Pilling) £2
Speech 21 (Superior) £2
Studio24 Pro (Pineapple) £13
Touch Type (IOTA) £4
TurboDrivers (CC) £4
Vector (4Mation) £8

Games (Carriage £2)

Alone in the Dark (Krisalis) £2
Birds of War (4D) 2Mb £11
Break 147/Superpool £2
Burn Out (Oregon) £2
Cannon Fodder (Krisalis) £2
Carnage Inc (4D) £2
Chocks Compendium £2
Chuck Rock (Krisalis) £2
Crystal Maze (Sher) £2
Cyber Chess (4D) £2
Darkwood (Eclipse) £2
Dune II (Eclipse) £2
Empire Soccer (Maglm) £2
E-Type Compendium (4D) £2
E-Type 2 (4D) £2
Fire & Ice (Times Warner) £2
Global Effect (Eclipse) £2
GODS (Krisalis) £2
Haunted House (4D) 2Mb £2
Holeat Out Compendium £2
James Pond (Krisalis) £2
Krisalis Collection £2
Lemmings (Krisalis) £2
Lemmings for RiscPC £2
Lotus Turbo Chalk! (Kris) £2
Magic Pockets (Feneq) £2
Man United Forever (Kris) £2
Oh No More Lemmings £2
Play it again Sam 2/3 £22 ea/chk
Populous (Krisalis) £2
Repl McCoy 2/3/4 £27 ea/chk
Repton 3/4 (Superior) £22 ea/chk
Sally & Andy (Oregon) £2
Saloon Cars Deluxe (4D) £2
Scrabble (US Gold) £2
Sim City (Krisalis) £2
Sim City 2000 (RPC/A5k) £2
Simon the Sorcerer 2Mb £2
Spotblot Fantasy (4D) £2
Starfighter 3000 (Fednet) £2
Stunt Racer 2000 (4D) £2
SWIV (Krisalis) £2
Time Machine (4D) £2
Virtual Golf (4D) 2Mb £2
Wolfenstein 3D (Powerslave) £2

Educational (Carr. £2)

10/10 Series £20 ea/chk
Early Essentials (over 7), English (6-16yrs), French (8-16yrs), Junior Essentials (5-11), Maths (Number) (6-16), Maths (Algebra) (6-16), Maths (Statistics) (6-16), Spelling (over 7), Fun School 3 (<5, 5-7, >7) £1
Fun School 4 (<5, 5-7, >7) £1
Fun School 5 (<5, 5-7, >7) £1
Maths Circus (4Mation) £2
Maths Circus (4Mation) £2
Naughty Stories Volumes 1 or 2 £58 ea/chk
Playdays (Clares) £2
Ridiculous Rhymes £2
Rosie & Jim - Duck loses its Quack £1

Desktop Projects Ltd Tel: 0161-474 0778

Authorised Acorn Dealer, Fax: 0161 474 0781, Email: info@desktopp.demon.co.uk

Unit 2A, Heapriding Business Park, Ford St, STOCKPORT, Cheshire. SK3 0BT



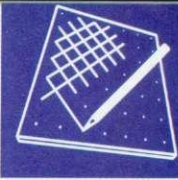

Graphics

Acorn artists & designers only

TJ REPRODUCTIONS, arguably the best Acorn repro bureau of them all, now offers a new service dedicated to Acorn graphics users. Using state-of-the-art, 64Mb, Postscript 2 dye-sublimation printers, the one week service costs £12.50 for the first 9.5x13in high gloss print and just £7.50 thereafter.

Officially this is open to Acorn users only, and is less than half the standard price for professional proofing. It is true that printers like the Epson Stylus and BJ600 are a cheaper alternative but not even the impressive Fargo Primera or colour laser copiers can match the size and quality of output from TJ's true photoreal equipment.

As would be expected of a high end repro house, the bitmaps and vector graphics can be colour matched to different printing press standards or to the screen display.

Bitmap files such as Sprite, Tiff and JPEG are supported as are *Compo*, *Artworks*, *Draw* and *Vector* graphics, even *Impression* documents; all acceptable on most types of removable storage media.

Specifically aimed at schools, young artists and designers, it seems the service will enable schools and non-professionals to attain professional quality final output at an affordable price.

TJ Reproductions
Tel: 0171-372 4430

Hot tips for the October Show

There has been much in the way of new graphics software in the last six months but hardware will be the pulse-raising element at this year's Acorn World.

Look out for Irlam Instruments' MJPEG card, deals on the superb Risc TV podule and the long awaited Video Desk. Lots of stands will be featuring StrongARM technology, none less than Acorn themselves. I look forward, once again, to the demos and wizardry of the Bondar and Cox variety. I am sure that graphics users will not be disappointed by this very real technology.

Professional grade 3D graphics has been threatening to burst out into the open for longer than many have been comfortably able to bear. What better a time then to reveal all.

Finally, not wishing to forget other users whose needs are more practical or simple, keep a keen eye open for some super deals on DTP applications, multimedia hardware and graphics stuff. With all the new releases there are bound to be some fantastic bargains around. CC, Clares, Spacetech, Pineapple, Alternative Publishing, Beebug and Oregon are the Graphics Page's hot tips.

Draw aid 3

Not having reviewed any of the previous versions of *Draw Aid* from Carvic, number 3 is simply too good to ignore. Owing to a lack of room on this month's page, we are not able to preview the application in full, but at first glance it works remarkably well as a very easy to use, multitasking BASIC programming tool for creating otherwise extremely time consuming vector graphics. More next month.

Carvic, tel: (01309) 672793

Contacting me

You can contact the graphics and DTP page by writing to me, Jack Kreindler at *Acorn User*, Media House, Adlington Park, Macclesfield SK10 4NP, or by email to augrafix@idg.co.uk.

Pics of the Month

SCIENCE fiction is the theme with Nigel Wood's winning picture this month. The piece, entitled *Galactica*, looks as if it has been rendered on a Sparc or similar but was in fact originated using a combination of *Architech* and *Photodesk*.

One of the other images, *Abduction*, was actually A2 sized originally and makes good use of *DaVinci's* powerful 'environment-mapping' rendering technique, *Artworks* and *Photodesk*. A number of other bitmaps were supplied as JPEGs on just a single floppy; the second month running that enough for a good portfolio has been supplied on a single disc.



Galactica and *Abduction* (below) by Nigel Wood from Lympington. Who needs Silicon Graphics?

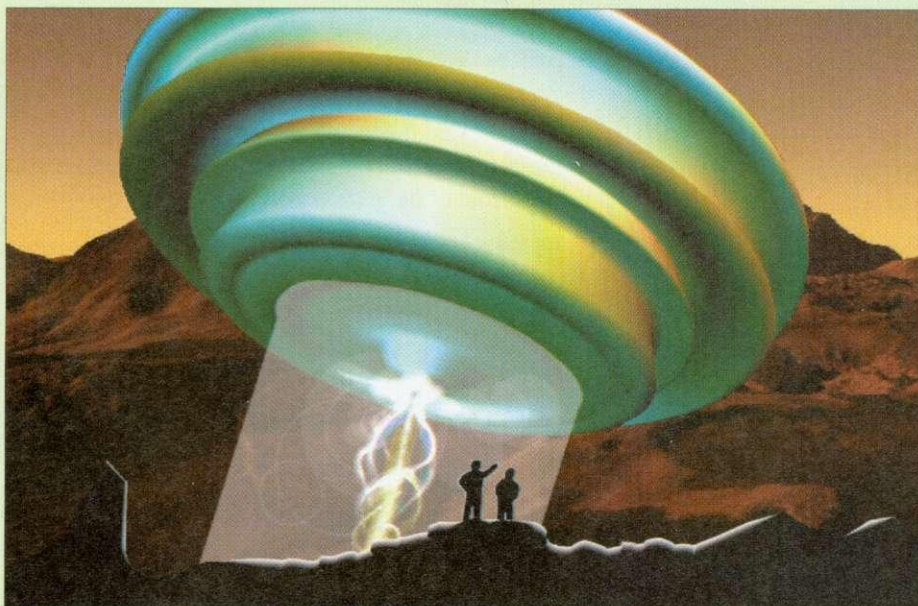

COLTON software

Going Strong(ARM)!

Colton Software's Fireworkz Pro in action ...



Each of these fields is filled in automatically from a database of names and addresses

Many wordprocessing functions like auto-format are available in the spreadsheet

Columns can vary in width and height as frequently as you wish and in any combination

This area of the spreadsheet is used for workspace and can be made invisible if desired

Chip	Clock (Mhz)	Speed (MIPS)	Speed (KDrhy/sec)	Date released	KDrhy/sec-MHz	
Prototype ARM	8	4	5.3	1985	0.662	StrongARM
ARM2	8	4	5.8	1987	0.725	228
ARM250	12	6	8.6	1992	0.717	290
ARM3	25	12	15.6	1990	0.624	1996
ARM3	33	15	18.5	1991	0.561	will be
ARM3	30	25	32.5	1994	1.083	1.2719298
ARM610	40	34	42.5	1995	1.052	0.5606061
ARM610	66	38	80	1997	1.212	
StrongARM	228	180	290	1996	1.272	
StrongARM	260	182	330	1997	1.269	

Today's date is also filled in

See us at Acorn World 1996 at stand 116!

The powerful array of spreadsheet functions allows decisions to be made which then can be exported to another document eg; this letter.

As you can see, the letter uses the figures from the spreadsheet. What's more is it's all dynamic - altering the table above instantaneously updates the letter with the correct information, rewording itself if necessary

The graph was brought in from the spreadsheet. The powerful graph engine allows informative and personalised graphs to be created with ease and be updated dynamically whilst retaining the user's changes

Dear Title Initial Name,

Date: 14 August 1996

You will be pleased to hear that the 228Mhz StrongARM running is now the most efficient ARM chip available as it does 1.27 KDrhytones/sec/MHz. It can develop 290K Drhytones/sec and will be available in 1996.

The least efficient chip was the 33Mhz Arm3 which only does 0.56 KDrhytones/sec/MHz. It can develop 18.5K Drhytones/sec and was available in 1991.

I hope you will take this opportunity to buy this new chip as it will allow you to have the most efficient machine possible. Losing any machines with 33Mhz Arm3 chips in them may also be a good idea as they are very inefficient chips. You can refer to the graph below for further details.

Yours sincerely,
Colton Software.

Colton Software has always been here:- since the inception of the BBC Micro with the legendary View suite of productivity software - so good that it was shipped in ROM with every BBC Master. We always have, and will be continuing to produce software of the greatest quality and power.

Our suite of productivity software across PCs and Acorns continues to be unrivalled, and as we continually update and enhance our software for this ever-changing world, we remain at the forefront of the Acorn world.

As Acorn User said in July 1996's edition, "Fireworkz is something you should really check out".

Why not do so, right now?

Please send me a demonstration disc of:

Fireworkz Fireworkz Pro

Name: _____

Address: _____

Postcode: _____

Product	Version	Price*	Description
Fireworkz Pro	1.30	£149.00	As below, but with database
Fireworkz	1.30	£99.00	Integrated word processor, spreadsheet and graph package

* Price excludes VAT and P&P. Special upgrade prices from other Colton products exist - please ring for details. E&OE

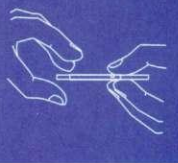

StrongARM power

AS more technical details of the new StrongARM become available I've been particularly interested in details of the new processor's low level function. Judging purely from technical reports from the manufacturers, the new processor is set to be as much of a revolution in performance since Acorn first strapped a cache on to an ARM for the groundbreaking ARM3 – perhaps even more so.

As well as the radical increase in clock speed, important improvements to the caching and cycle time of the instruction executions will have a dramatic effect on processing power with major benefits for graphical code. The separate 16K instruction and data caches will certainly relieve some of the bottleneck imposed by the bus, although straight shifting of bitmaps to the screen is unlikely to receive much of a boost.

Of equal importance is the acceleration of the execution of many instructions, most of which execute in less cycles than on previous ARM chips. While common instructions like branching, ADDs and MOVs execute in only two cycles compared to three cycles on older processors, the MUL instruction takes a maximum of only three cycles. The number of cycles to perform this instruction varies depending on the size of the numbers being multiplied, but in its worse case, this could have taken up to 17 cycles on the ARM700.

These dramatic improvements will be particularly invaluable to the 3D graphics coder who performs many calculations for each pixel of the screen. In my early days as a demo coder on the old ARM2, *real time ray tracing* used to be an in joke describing the next effect we were working on, but the reality is really not that far away.

In addition to the great benefits of the StrongARM, there are drawbacks. Self modifying code is only possible with the use of a

very expensive *SynchroniseCodeAreas* call, and this will lead to major problems with existing code that uses this method without the call. Problems are also encountered over previously recommended compaction tools. Self expanding archives, like those produced by BASS's *Crunch* utility do not work on the StrongARM. Watch out for Crunched versions of *Acorn User's* QTM module which will cause problems.

As the overall design of the ARM processors becomes more complex, the very direct and obvious way of coding is taking a big change for the StrongARM. In some areas, performance may actually be reduced, as is the case when reading data from uncached areas like the screen. Conversely, many of the new methods of operating the cache and write back buffer can be used positively by code tailored to their method of working.

Many of these details are outlined in the technical specs available from Digital Semiconductors, but much experimentation will be needed before it is clear how best to optimise code to exploit the power of StrongARM to its full. As the StrongARM comes into use in the PD scene I'd love to hear from anyone who gets to grips with these aspects of the processor. I'll certainly be covering the effect and potential that the new processor has for the PD scene over the coming months.

Programmers who have so far succeeded in protecting their bank balance from the ever increasing temptation of the new StrongARM, will receive a renewed assault from the details found in Digital's introductory technical specs and guidelines. These can be located on the Digital Databank BBS. Further information can be found in the StrongARM Technical Reference Manual, available from Digital Semiconductor's WWW site at <http://www.digital.com/info/semiconductor/dsc-strongarm.html>

Fishtank simulator

THIS rather unusual idea is the first mini demo from a group new to the Acorn scene. DFI have produced a little 3D world, populated by gourrard shaded fish. The surrounds of the fishtank are light sourced in a highly colourful manner, producing an interesting background to the fish themselves.

A shoal of tiny vector triangles swims around the foreground of the picture, and a much larger shark type fish circles the tank menacingly. This little loader certainly shows off the group's 3D talents, but I couldn't help noticing little niggles present in the polygon rendering routines, and an apparent bug in the fill routine that causes flickering horizontal lines across the screen on odd occasions. It's this attention to detail that the Acorn demo scene has often lacked in the past.

The team are promising further releases soon, including a 3D megademo entitled the *White Room*, which should hit the streets in October. *Fishtank* is available from the Arcade BBS and from 5 Star on disc D79.

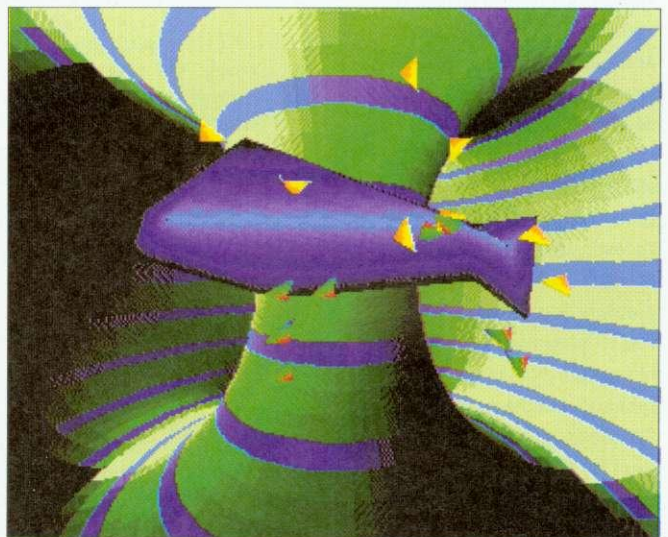

WebGif2

WEBGIF has been mentioned before in David Matthewman's HTML tutorial, but I thought this handy little program deserved a further mention here. Producing graphics for web pages is all about compromise – getting the best graphical appearance out of the smallest

file size. *WebGif2* helps you to do this by giving easy drag and drop conversion of sprite files to web standard Gif files that incorporate several extra features.

The most valuable of these is the Mask, which allows images to be given a transparent background. You can also

make an image interlaced so it can be displayed a bit at a time as it is downloaded for display on someone's web page. *WebGif2* is available on the net from author Ian Jeffray's web site, at: <http://www.compulink.co.uk/~paradise1/ian.html>



Public Domain

Games on the way

The recent flood of PD games looks set to continue as up and coming groups on the scene, Arm'd and Dangerous and Gilbert The Hamster Software continue to release new programs. GTHS are working on a new game – the “Advanced run for the bus simulator” and the latest news from Arm'd and Dangerous can be found on a new web site at: <http://www.argonet.co.uk/users/robert.t/>

Optic

The *Optic* disc magazine can be obtained for just £1 per issue, or £2 for all three issues, direct from Jonathon Gutteridge at: 2 Newton Close, Eaton Rise, Norwich NR4 6RB. Apologies to Jonathon for omitting the prices in the September column.

Acorn World

Despite writing this at the height of summer, the time of the biggest Acorn show of the year is approaching fast. As always, it looks set to be the most exciting Acorn event on the calendar and its significance to the PD scene is no exception to this rule.

I'll be on the *Acorn User* stand all day on the Saturday, so please come along for a chat. As always, I'd love to hear your views on the PD scene and help out with any problems you might have. Feel free to bring along your PD for review in the column or submission to the cover disc and PD scheme. A special Digibank meet for PD enthusiasts and BBS users is taking place on the Saturday at 2.30pm at the *Acorn User* stand.

Contacting me

You can contact the PD page by writing to me, Paul Wheatley, at Acorn User, IDG Media, Media House, Adlington Park, Macclesfield, SK10 4NP. Or preferably, by e-mail to aupdp@idg.co.uk.

Software requests

ACORN USER PC columnist, Mike Buckingham, is looking for a specialised application to record the cost of voice phone calls. The ideal app would provide a mini database of contacts linked to a mouse controlled stopwatch window.

When making a call, the user would select the contact from the database and time the call with the stopwatch. This information would then be used by the program to calculate the cost of the

call and append the details to a spreadsheet or log file.

In response to John Billings' request for an Apple Mac to Acorn sound convertor, *Dis-le* author, Mike Smith has a *ConvSnd* application that currently only converts the other way. Mike might be able to help however, and can be contacted by email at: mike@msmith.zynet.co.uk or by snail mail at: 26, Grenville Road, Saint Judes, Plymouth, Devon, PL4 9PY.

ARMEdit

ALEXANDER THOUKYDIDES has just released a new version of his popular *ARMEdit* software. This suite of utilities provides a host of aids for the use of Acorn and Aleph One PC podules and co-processors. The new release adds many new features, including a DOS device driver that allows RISC OS filesystems to be read from the PC just like normal DOS drives.

Support for Acorn's PC emulator has also been added. Full documentation and library code has been included to allow other programmers to write their own software using the comprehensive communications facilities provided.

ARMEdit is freeware, and may be downloaded from <http://www.tcp.co.uk/~thouky/tcfa.html>

StrongARM disc

THE CD-ROM Acorn plans to release with the new StrongARM processor will include several new demo releases. A number of demo crews have been enticed by the chance to show off what the StrongARM can do, and judging from both eye witness reports of the StrongARM, and details of the technical specs (see StrongARM power) they are likely to be very impressive.

Contributors include co-author of *Xtreme*, John Tytgat, the master of everything innovative, Frederic Elisei of Arm's Tech, as well as productions from demo veteran Tor Houghton and a release from my own group, Quantum. According to my inside information, the highlight will be a mandelbrot routine from Frederic that can be scrolled and zoomed in realtime. I'll be casting my usual critical glance over these releases in a couple of issues time and hopefully we might even have them on display on the AU stand at Acorn World.

Flashback

FOLLOWING up Nathan Atkinson's request for a music patch for the popular commercial game, *Flashback*, Stephen Harrison has provided an excellent solution to the problem. The Acorn conversion of *Flashback* from the Amiga uses an inferior music player that not only plays the music out of time with the game, but also does it rather inaccurately. Fortunately we now have an easy to use patch created by Protracker music guru, and *QTM* author himself, Stephen.

All you need to do is double click on the *!FBackQTM* patch located on this month's cover disc, and then run your copy of *Flashback*.

While I'm on the subject of music, Stephen's *Q The Music* player has now reached version 1.27, which now offers a host of features ideal for the budding demo or game coder. The player module itself is included with the *Flashback* patch described above, but the complete programmers pack with full info of how to use *QTM's* new features can be found on the Digital Databank BBS.

The latest version of Chris Rutter's front end for the music player, can be found on the net at: <http://www.doggysoft.co.uk/qtplay/>.

TMNP

PHIL WEBSTER has started a regular sprite based cartoon strip that will be available direct from the Digital Databank BBS. Phil's graphics are surprisingly effective given his use of Paint for all the drawing, and are well worth checking out.

Rumours on the BBS hint at a possible collaboration with a team of other users and a possible relaunch of the *New Dawn* disc magazine. *Teenage Mutant Ninja Potatoes* can be found in the graphics section of the Digibank BBS.

Recommended PD Libraries

The Datafile, 71 Anson Road, Locking, Weston-Super-Mare BS24 7DQ

Naked PD, 'Fayence', Fulford Road, Stoke-on-Trent, Staffs ST11 9QT

Arch Angel PD, PO Box 41, Exeter EX4 3EN

APDL, 39 Knighton Park Road, Sydenham, London SE26 5RN

Five Star Marketing, 4 Shepherds Walk, Bushey, Hertfordshire WD2 1LZ

Beebware PD, 83 Forrest Road, Huncote, Leicester LE9 3BH

ARM Club PD Library, Freepost ND6573, London N12 0BR

Risc World PD, daniel.hayes@argonet.co.uk

FREE
CD Player or
Personal Stereo

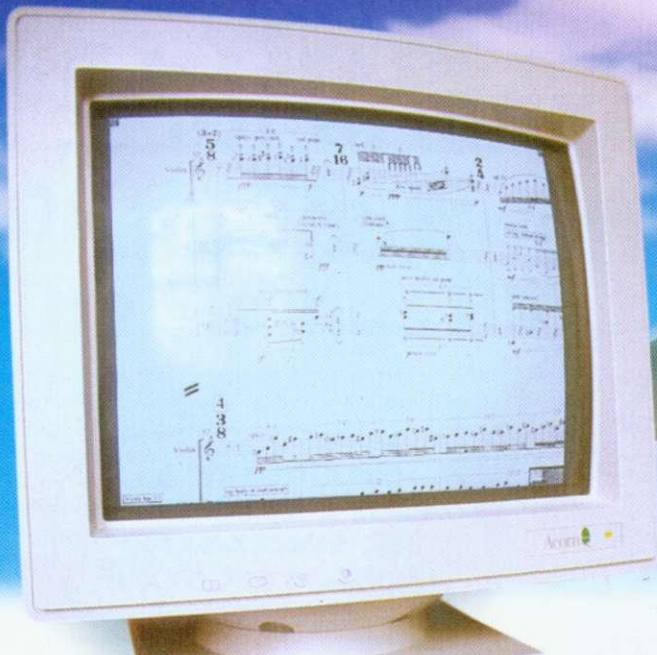

Sibelius – free gifts for Xmas.

TREAT yourself to one of the world-famous Sibelius music programs for Christmas – and get a Sony CD player, Aiwa personal stereo or CD-1000 headphones for free!

Simply buy your Sibelius program before Christmas from any dealer, then return the voucher below with your registration card, to claim your amazing free gift!

Choose between our new beginners' program **Junior Sibelius!** (£49+VAT, covers National Curriculum Key Stages 1+2), **Sibelius 6** (£179+VAT, for GCSE), **Sibelius 7 Student** (£495+VAT, for A-level and semi-professional work) or the state-of-the-art professional **Sibelius 7** program (£888+VAT).

The Sibelius programs need no introduction – suffice to say that they are the most highly-acclaimed music software on any computer, used by such famous names as the **BBC, Royal Academy of Music, Royal College of Music, Yehudi Menuhin School, National Theatre, Oxford University** and thousands of others.

They've received rave reviews throughout the computer and music press – and in almost every national newspaper, including **The Times, Sunday Times, Independent, Financial Times** and **Daily Telegraph**.

To find out more about the Sibelius programs, contact your local dealer or Sibelius Software today, and ask for an information pack and free demonstration disk.

"This extraordinary computer program has changed the music world forever"
– **The Times**

"In a totally different league from anything else"

– Paul Patterson, Professor of Composition, **Royal Academy of Music**

"There are countless educational possibilities for this software"

– **Music Teacher** magazine

"Instantly captured the imagination of staff and pupils alike"
– Paul McMasters, Head of Computing, **Winchester College**

"Sibelius 7 feels as if it has musical instincts" – **The Independent**

"The biggest surprise with Sibelius is how simple it is to learn and use effectively... the most comprehensive music package imaginable"
– **Times Educational Supplement**

"Dramatically reduces the time it takes to compose a piece of music"
– **Financial Times**

"As easy to use as pen and ink"
– **John Rutter** (composer)

"Sibelius 7 can notate, print and play a musical score at a pace even more rapid than Mozart at his most fecund... Imagine what wonders Bach could have worked with such technology"
– **The Times** leader column, 31.1.96

Sibelius Software, 75 Burleigh St, Cambridge CB1 1DJ
Tel: 01223 302765 • Fax: 01223 351947
email: info@sibelius.demon.co.uk
http://www.acom.co.uk/developers/sibelius/

Please send me my FREE...

AU 11/96

- Sony Discman portable CD player** (*Sibelius 7 & 7 Student purchasers only*)
- Aiwa Personal Stereo** with super-bass, bass/treble control and 3-way auto-reverse (*Sibelius 6 purchasers only*)
- CD-1000 stereo headphones** (*Junior Sibelius! purchasers only*)

To claim your free gift, buy your program from any Sibelius dealer and then return your registration form with this voucher stapled to it, in an envelope, to Sibelius Software to arrive no later than 31.1.97.

Only applies to programs bought between 1.11.96 and 25.12.96 inclusive – we reserve the right to require proof of purchase. Limited to one free gift per purchaser. Upgrades, updates and extra stand-alone copies are ineligible. Site licences and bundles count as a single program for this purpose. This voucher will not be accepted if returned separately from registration form. May not be used in conjunction with any other special offer or discount. We reserve the right to substitute an alternative gift of similar specification if necessary. Voucher nominal value 0.001p. E&OE.

Site licences & bundles available – details & prices on request. Prices quoted are UK RRP's, which may change. See voucher for free gift conditions. E&OE

Rest, O Christ
Ο Θεωτάριος ὁ Χριστέ



Argo - the experts for Acorn Internet Access

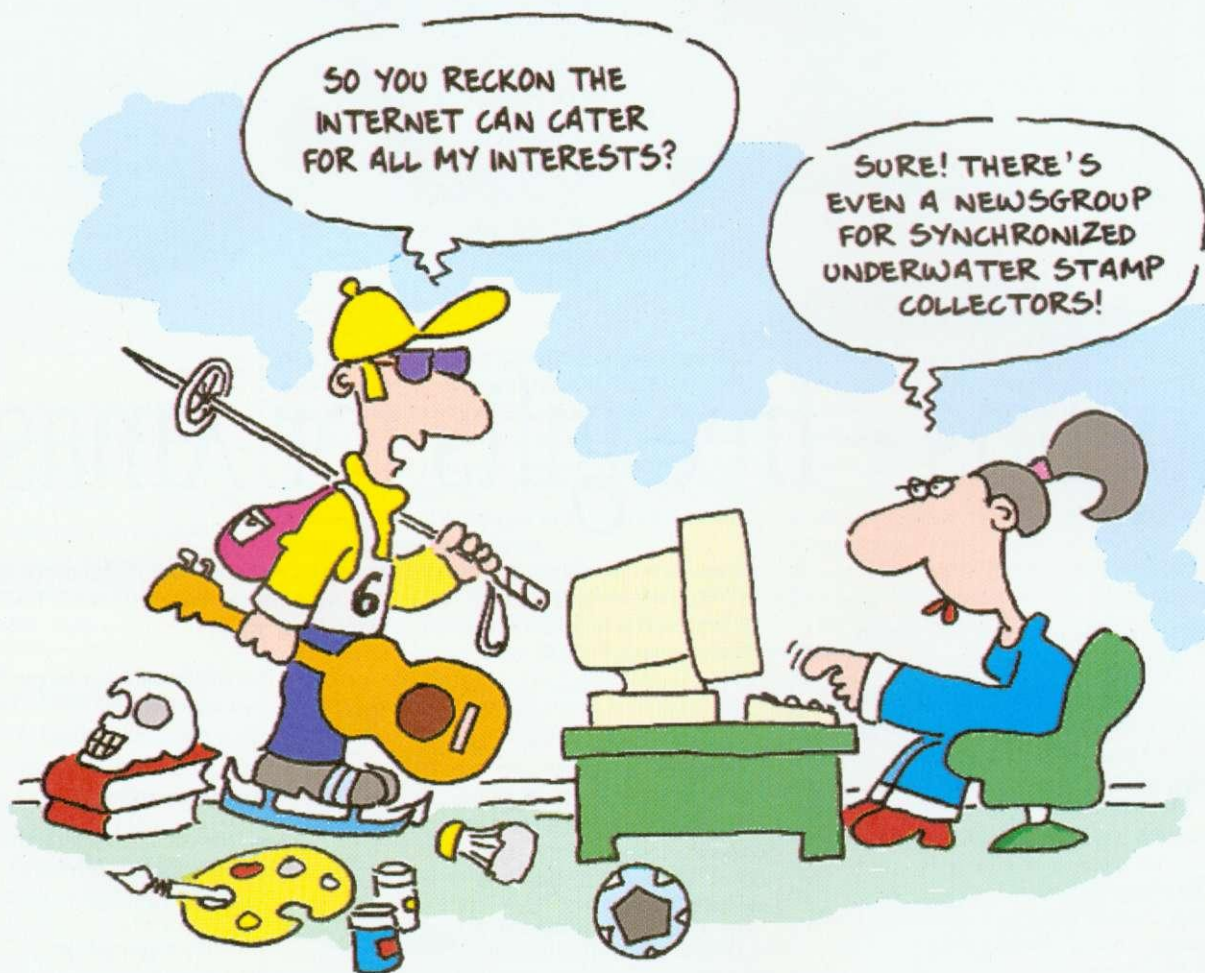

There is something for everyone on the Net! For further details on the full range of Argo packs including the Voyager access software, contact:

ArgoNet, 1 The Shopwhyke Centre, Chichester, West Sussex, PO20 6GD
Tel: 01243 788668 Fax: 01243 531196 email: info@argonet.co.uk

a r g o

 vti

and  will be at

Acorn
WORLD

Come to our stand to see the Net in action, get the best deals on hard drives and CD-ROM systems, or try out the VTi and Eclipse range, including the SoundByte Recorder, HeartBeat, Darkwood and Dune II

Comms

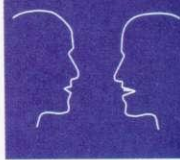

On the Up line at The Sidings BBS

IF you think there might be a connection between The Sidings BBS and railways you'd be right, but sysop Gary Parr is no mere trainspotter. He has always been fascinated by the railways and hopes to make a career in the rail business with that *Boys' Own* dream occupation of train driver. Gary successfully combines his enthusiasm for science and technology with his railway interests in running The Sidings BBS.

Gary Parr and co-sysop

Matthew Cook started The Sidings BBS in July, and the BBS has been growing steadily ever since.

Located in Nottingham, The Sidings BBS runs *ArmBBS* on an A305 with 1Gb of IDE discs, a 100Mb SCSI hard disc, CD-ROM drive and a SyQuest EZ 135 drive for backup. The Pace MicroLin FX Plus modem allows connections at up to 14k4 bps, and Gary hopes to add a 28k8 Sportster and another line later this year.

The Railway Related section includes a local rail area map, rail news, timetables and information on preserved railways, and there are plans for a railway filebase. The Football area, edited by Neil Cartledge, contains up-to-date reports and information on mat-

ches, forthcoming fixtures and player statistics and there is a large selection of Liverpool pictures in the BBS filebase.

The Games and Doors sections offer callers other means of recreation; there's even a sneak preview area describing what's going to happen in various TV Soap series. Other special sections include the ARM Club with its own filebase, ARM'd and Dangerous Coding group files and a large collection of GIF and JPEG pictures in the Media Freeform filebase as well as up-to-date Acorn, FTP Mirror and PC files.

The Mail Room at Sidings BBS contains some local areas and a large number of networked RiscNet and X-Net message areas, and the user list already contains many names familiar to users of other Acorn BBSs. To add yours to the list, you can call The Sidings BBS at any time.

The Sidings BBS
(0115) 9563481

Homepage automation

Many Acorn users have been busily setting up their own **Demon Internet** Homepage WWW sites. Roy Fellows has come up with a very useful script-generating program to enable **!TCP/IP** users to upload and refresh such web sites automatically. Direct your browser to <http://www.tilmun.demon.co.uk/cub/roy/uplhome.spk> making sure that you save the resulting file as HTML if the browser tries to display it.

Icarus Allsorts BBS

David Hart is causing a stir among invited callers with his new BBS system called Icarus Allsorts BBS. It's a hybrid system running *ArmBBS* on an 8Mb ARM3 A310, but with RiscBBS performing some background tasks on an A3010, linked to the other machine by a Virtual Hard Disc Server called SerNet by Andrew Timmins. Unique menus and novel animated graphics make this BBS one to watch out for when its final phone number and online times are settled.

Icarus Allsorts BBS
Ring voice first on (01977)
620702

URL of the month - Messenger

Mark Sawle's e-mailer and newsreader **!Messenger** is gaining popularity with users of **!NewsBase**, Graham Allan's Internet mail resource database. Although compatible with and usable as an alternative to Robert Orwin's **!ITTFN** mailreader, Mark recommends you use one or the other and join his **Messenger** mailing list to keep up with the latest developments. You can find out more about **Messenger** from Mark Sawle's **Messenger** pages.

Messenger Web pages
<http://www.locutus.demon.co.uk/messenger/>

Contacting me

Send me any Acorn-interest URLs you find, and I'll publish a selection. You can contact me by writing to David Dade, Acorn User, IDG Media, Media House, Adlington Park, Macclesfield, SK10 4NP, or by e-mail to: DavidD@arcade.demon.co.uk, or mail #2 on Arcade BBS 0181-654 2212.



On the right lines at the Sidings BBS

YoUR List of Acorn Interest Web Sites

YET more Web sites recommended by you:

- <http://www.siren.uk.com/siren> - Siren Software Systems' web site includes some Careware programs to download for Acorn 32-bit computers
- http://www.webzone1.co.uk/abell_broadcast/info/acorn.htm - Ned Abell's Acorn section of the Webzone site with links to useful Acorn resources
- <http://www.ant.co.uk/~peter> - Peter Hartley's home page contains interesting graphics, thought-provoking reading and useful PD Web tools to download such as Intergif
- <http://www.foobar.co.uk/dialin/utopia/DFI.HTM> - Home page of Demo coding group DFI includes a link to download their soothing **!FishTank** demo
- <http://www.users.dircon.co.uk/~kozzev/acorn/> - A page dedicated to the community of regular users of the IRC channel #acorn
- <http://www.guernsey.net/~surcombe/> - John Surcombe's home page and link to his **QWiK** offline mail reader page, where you can download the latest version
- <http://www.aberry.demon.co.uk/programs/> - Andrew Berry's Freeware program pages
- <http://www.infotrek.demon.co.uk/freeware/qedit/> - Home page of **!Qedit**, David Croft's outgoing e-mail and news re-editor
- <http://www.ph.kcl.ac.uk/~amb/riscbsd/> - Official home of RiscBSD, the ported version of NetBSD unix for the Acorn RiscPC
- <http://www.tcp.co.uk/~thouky/tcfa.html> - Home page of **ARMEdit**, a suite of Freeware utilities for use with Acorn and Aleph One PC cards, and Acorn's **!PCEm**
- <http://lucy.cs.waikato.ac.nz/~pnaulls/acorn-archives/> - The HTML version of the list regularly posted to comp.sys.acorn, of FTP sites containing Acorn or Acorn-related software
- <http://www.ark.org/users/Ali.html> - Alasdair Bailey's selection of saved cities for the Acorn version of **Sim City 2000**, and photographic backdrop sprites for use with the Risc OS pinboard
- <http://performance.netlib.org/performance/html/dhrystone.data.col0.html> - Dhrystone Performance Web page listing some of the fastest machines around, where the RiscPC SA110 comes in 8th from the top of 291!

The latest in a great line of offers
from

CUMANA

Cumana, in partnership with Anglia Multimedia, bring you a unique opportunity to take the first steps into equipping for multimedia.



SPECIAL CD-ROM PACKAGE

- * **The Oscar CD-ROM Drive**
(including Acorn and PC driver software and a set of mini stereo headphones) plus
- * **A FREE CHOICE of 4 from 14 Anglia Multimedia CD-ROM titles**

**For the
Special
Price of
£299**

(including delivery and exc. VAT) Order Code: Anglia.Off
(Offer ends 31st November 1996)

The New QUAD SPEED Oscar Drive

Now equipped with quad speed performance and featuring a computer/CD audio mixer plus a 256Kb cache memory. With fast, reliable

performance Oscar can access a whole range of CD-ROM's, audio CD's, Kodak Photo CD's and fully support the most powerful multimedia applications.

Oscar is simple to connect and being external can be moved between computers and platforms. Being parallel connected Oscar has a 'through printer port' to connect other parallel devices giving complete flexibility.



Choose your 4 titles from:

- Seashore Life
- Garden Wildlife
- Vikings!
- Romans!
- Exploring Castles
- Nelson and His Navy
- Eureka: An Encyclopedia of Discoveries and Inventions
- Understanding Energy
- Understanding the Body
- Being a Scientist
- Looking at Animals
- Survival's Mysteries of Nature
- British Isles from the Air
- The World's Weather

Call the CUMANA team for full details of this offer or a copy of our latest catalogue.

Tel: 01483 503121

Fax: 01483 451371

E-Mail: sales@cumana.co.uk

Cumana, Boundary House, The Pines, Broad Street,
Guildford, Surrey, GU3 3BH

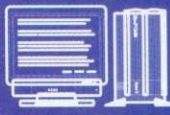

Masterclips collection

EVEN the best art package cannot turn someone like me into an artist. The best solution is to resort to clipart. Browsing around PC World I came across a shelf loaded with it. I chose IMSI's *Masterclips* – a collection of 35,000 images including artworks, photos, fonts and borders.

It installs easily and runs smoothly on my system. Browsing is easy and selection of images very simple. An icon allows you to save a selected image to the clipboard from where it is available to any other Windows program that can access it – and most do. If you have *PC Exchange* running, your selected clip image is also available to anything in RISC OS. Switching back to the RISC OS desktop will show *PC Exchange* holding a data file which can simply be dragged either onto a suitable directory and saved, or direct into a package like *Impression*.

The transfer works well but you can run into problems with colour images – pure colours are rendered as tartans or become

blotchy. This happens if the display settings in *!PC* config are set to low res. If you reconfigure to high res, the colours are rendered properly.

The collection comes on two CD-ROMs with a substantial printed directory, in which the images are displayed as thumbnail black and white sketches.

The images are inevitably biased towards America – policemen wear US uniforms and the history section is heavily populated with US figures although some of the major world politicians are also included. There are also maps and cultural images from around the world.

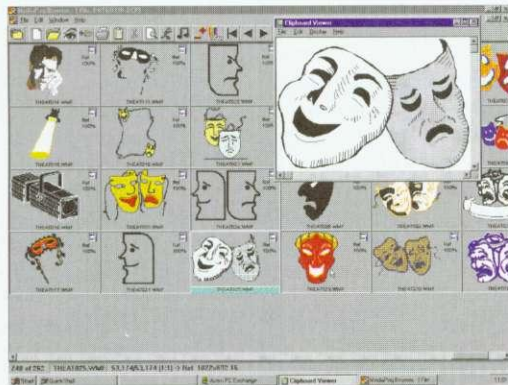

A browser lets you view the images by category

Note on installation:

In Win95 I had to go through the My computer/'new programme' route as the d:\install function via the 'run' option didn't work as described in the loading notes – Win 95 claims not to be able to find the install file. In fact this isn't that unusual – so bear it in mind if something refuses to install as expected.

Learn to speak French?

OR perhaps Spanish, German or Italian. Over the last few days I've wished I could afford another computer – getting at my own has been difficult due to a language software package from The Learning Company. The *Learn to Speak* series isn't exam oriented, it is aimed squarely at amateurs – people who want to go to a country and get by. It concentrates on practical, everyday language and includes sections on business phrases and expressions too. It may be of use to language students taking GCSE – but don't expect it to relate to the syllabus.

I haven't had much of a chance to play with them to be honest but my better half has given the French CD a good going over and my six year old has been curiously addicted to the Spanish course. They include sections of straight vocabulary, each section based upon a theme: you click on words and they are pronounced and translated. You can also

hear them in context – a native speaker reads out a sentence which includes the chosen word or phrase, the text being displayed in both original and translation. Substantial use is made of 'movies' – you can see the person speaking the words. You could, of course, limit yourself to that but if you want to delve deeper and be more rigorous, there are also full grammar notes available at the click of a mouse.

Criticisms are few, but some exercises are rather over-pedantic. If, for example, you type in a phrase correctly but omit an accent, you'd expect to be told off. However you are also marked down if you forget a capital letter or even a comma. Until you know precisely what the exercise wants, that can be frustrating. Again, the software is oriented towards Americans. When you boot up the Spanish programme and expect to see a map of Spain, you actually see Mexico.

From the technical stand-

point there were no problems loading it (I've tried the French and Spanish versions) under Win95 and they should be equally suitable for 3.x. They run well. The sound is mostly very good, though it appears to be out of sync with the video much of the time.

The main problem is with compatibility: if you had a 'real' PC with a record capable soundcard, this programme allows you to record your answers and claims to be able to recognise whether you have spoken the right word or not. It will even comment on your accent. How good this is I don't know but a word of warning – I tried pressing the record button and everything locked solid. So don't.

Alph One tell me there may be a way to get the record function working even though it's not supported by *!PC*. I'll let you know if I succeed as it could be useful, not only for individuals but for schools and possibly for other software too.

!PC news

In my last column I announced that the new *!PC* would be available and would be called *!PC 96*. It has been renamed *!PC Pro* which won't date, and is now shipping. I've installed the beta version manually, but the full release should be a doddle as it includes an installer.

As promised it's the first version of *!PC* to support Windows 95 properly, and so far I've no complaints on that score. It fixes several bugs, includes faster screen drivers and supports shared memory options that increase the speed of the software markedly. I've noticed a definite improvement in my machine. It's tricky to be absolute about speed improvements, but loading times for large disc based programs (eg Word) has dropped by about 15 per cent, with all other settings unchanged.

Incidentally an extra 8M (to 16M) allocated to the card makes a similar, additional improvement.

It may not seem a huge amount, but in practise everything is noticeably quicker – animations, for example, are much smoother, and games requiring sound and animation are far less fragmented than they were. So far I haven't altered my drive_c to Direct SCSI which should make it faster still.

Alph One Tel: (01223) 811679

Tip of the day

Microsoft's Word comes up with a tip for the day, usually it's something vaguely useful about how to improve your technique with Word. The other day it helpfully suggested I should be careful with scissors – they can be dangerous! Thanks Uncle Bill, I never knew that.

Contacting me

You can contact the PC page by writing to me, Mike Buckingham, at Acorn User, IDG Media, Media House, Adlington Park, Macclesfield, Cheshire, SK10 4NP, or e-mailing to aupcpage@idg.co.uk

RiscPC+Upgrades

All RiscPC's & A700's include 1yr on-site maintenance.

RiscPC 600 (arm610)
4M/HD540 14" mon. **£1299.00e**

RiscPC 700 (arm710)
6M/HD540 14" mon. **£1549.00e**
10M/HD 1GB 14" mon. **£1799.00e**

Strong Arm upgrade

Available to order with new RiscPC at only £116.32

For 17" RKF90 monitor Add **£376.00**
For CDrom Drive 4x Add **£99.00**
For CDrom Drive 8x Add **£159.00**

All Computers are built and tested before dispatch with printers and software purchased installed as required at no additional cost

486-SX-33 PC Upgrade **£233.00d**
486-DX2-66 PC Upgrade **£292.00d**
486-DX4-100 PC Upgrade **£351.00d**
586-100 PC Upgrade **£468.00d**
Deduct £117.50 off PC upgrades when purchased with RiscPC

PC Exchange **£29.00a**
Windows 3.1 + DOS 6.22 **£59.00d**
Access+ Card **£139.00d**
Arm710 upgrade **£119.00d**
Strong Arm upgrade **£292.00d**
Audio Mixer **£40.00a**
Movie Magic **£279.00d**
Second Slice **£116.00d**
Sound Card **£69.00d**
RiscPC 4mb RAM **£25.00c**
RiscPC 8mb RAM **£49.00c**
RiscPC 16mb RAM **£99.00c**
RiscPC 32mb RAM **£219.00c**
RiscPC 1Mb VRAM **£149.00c**
RiscPC 2Mb VRAM **£245.00c**

Archimedes Comp

A4 Portable (1.8 Floppy & 4Mb ram
Frm 3 LCD Mon, 80Mb HD), **£1350.00d**

A7000 (1.6 Floppy & 4Mb expandable to
130Mb ram, Frm 7500 RKF60 M/S Mon,
540Mb HD, on site 12 months warranty)

4M/HD425 14" mon. **£1099.00e**
For 4xCdrom Drive Add **£100.00**

Pocket Book

Pocket Book 2(256k) **£239.00c**
Pocket Book 2(1Mb) **£319.00c**
A-Link **£59.00b**
M-Link **£59.00b**
PC-Link + **£59.00b**
Parallel Link **£29.00a**
Power Supply **£14.50b**
Flash SSD 1Mb **£119.00c**

Hardware Upgrades

Hawk V9 MkII **£194.00c**
Lark MkII Sound-Sa. **£172.00c**
Midi Max **£78.00c**
Risc OS Upgrade Chips **£36.00a**
SCSI 16bit **£95.00c**
SCSI 2 32bit **£205.00c**
TV Tuner **£99.00c**
TV Tuner + Teletext **£159.00c**

Data Storage

A30x0 CD Atapi interface **£84.00b**
Quad External Atapi CD **£178.00c**
A30x0 IDE interface **£89.00b**
A30x0 IDE/CD interface **£104.00b**
all above include HD fixing kit

IDE 2.5" **£99.00c**
170mb **£125.00c**
270mb **£289.00c**
540mb

IDE 3.5" **£210.00c**
1.0 gb Conner **£249.00c**
1.6 gb Conner **£229.00c**
1.7 gb IBM

SCSI 2 3.5" **£198.00c**
54k Meg Fujitsu **£289.00c**
1Gb 10ms IBM

IDE CD Tray Internal
Panasonic Quadpro **£99.00c**
Pioneer Quad **£99.00c**
Goldstar **£159.00c**

SCSI CD Tray Quad Internal
Toshiba XM-3501B **£259.00c**
SCSI CD Caddy Quad Internal
Toshiba XM-3501B **£299.00c**

PD SYSTEMS

4X speed CD-ROM Drive
650 MB Optical Disc Drive
Internal or External
Including 1 Cartridge **£539.00d**
Extra 650MB Cartridge **£45.00d**

Memory Upgrades

A3000 1-2mb **£64.00b**
A3000 1-4mb **£139.00c**
A3010 1-2mb **£53.00b**
A3010 2-4mb **£96.00b**
A3020 / A4000 2-4mb **£99.00b**
A5000 2-4mb **£99.00b**

All Upgrades fitted free if ordered with Computer else £18.00

Monitors

Acorn RKF60 **£380.00d**
Acorn RKF90 **£699.00d**
Iijama 17" MF8617E .28dot **£629.00d**
Iijama 17" MT9017E .25dot **£699.00d**
Microv 14" 1438 (mkf90) **£289.00d**
Microv 14" 1450 (mkf90) **£219.00d**
Microv 15" 1565 .28dot **£299.00d**

Mail Order

Tel: 01924 254800 Fax: 01924 258036
E-Mail: sales@davyn.demon.co.uk

Scanners

Epson GT5000 parallel **£399.00d**
Epson GT5000 scsi **£469.00d**
Epson GT8500 para/scsi **£529.00d**
Epson GT9000 para/scsi **£659.00d**
Scanlight 256 8bit **£184.00c**
Scanlight 256 16bit **£151.00c**
Scanlight 256 Video **£222.00c**
Image Master/Twin Driver **£39.00a**

Printers

Canon BJ-30 (black) **£149.00d**
BJC-70 (black) **£209.00d**
BJC-210 (colour) **£169.00d**
BJC-230 (black) **£311.00d**
BJC-4100 (colour) **£259.00d**
BJC-610 (colour) **£389.00d**

Epson Stylus Col 2 (colour) **£299.00d**
Hewlett Packard DeskJet 600 (Black) **£199.00d**
DeskJet 660 (colour) **£349.00d**
LaserJet 5L (Black) **£399.00d**

Calligraph A4 1200 Laser (black) **£1150.00d**

Printer Inks/Refills

INKJET REFILLS FROM PREMIER INKS

Inkjet Refills are an economical way of re-charging your existing cartridge. All inks come complete with gloves, syringe and easy to use instructions. Single 20ml Any Colour **£6.70a**
Twin 2x20ml Black **£12.30a**
Bulk 126ml Any Colour **£23.00b**

'CartridgeMate' A new and



easy to use cartridge refill system for HP 1626A high cap. cartridges
A refill system with no mess
Comprises: CartridgeMate & 2 x 40ml Ink Tanks
Cartridge not included **£35.00b**
Ink Tank 2 x 40ml **£21.00a**
HP51626A Tri-Colour Cartridge refill kit 3 x 3 colour refills Comprises: C/M & Y Inks, Cap Retaining Clip Cartridge Cap Remover **£35.00a**
We also carry a large stock of inkjet cartridges and ribbons

Canon LBP-4 Toner **£69.00c**
Canon LBP-8 Toner **£79.00c**
HP LaserJet5L Toner **£59.00c**

Printable Items

Colour'n Weir (2 white Baseball Caps + 3 transfer papers) **£10.50b**
Colour'n Weir (2 white T Shirts + 4 transfer papers) **£13.50b**
Colour'n Weir (4 transfer papers only) **£7.50a**
(30 transfer papers only) **£41.00b**
Design & Print Fouse Mat **£5.00a**
Design & Print Business Cards 10x8 Inkjet matt photo white paper 25 sheets x 120gms **£5.50b**
Monochrome Inkjet brilliant white paper 100 sheets x 90gms **£3.00b**

CD Software

ArtWorks (CC) **£99.00c**
ArtWorks Clipart I (CC) **£20.00a**
ArtWorks Clipart II (CC) **£20.00a**
Being a Scientist (Anglia) **£44.00a**
Bitfolio Ed7 (Lino) **£69.00c**
Breakaway Maths (YITM) **£70.00c**
Britain from the Air **£44.00a**
Britain Since 1930 **£28.00a**
Cars-Maths in Motion (Cams) **£105.00b**
Dinosaurs (M/S) **£45.00a**
Castles (Anglia) **£44.00a**
Guardians of the Greenwood **£54.00a**
Granny's Garden (4Mat) **£35.00a**
Hutchinson M/Media **£45.00a**
Industrial Revolution (Anglia) **£94.00a**
Inventors & Inventions (Anglia) **£164.00a**
Kingfisher Childrens Micropedia **£93.00b**
Langsdale (CCS) **£104.00b**
Medieval Realms 1066-1500 **£164.00a**
Musical Instruments (M/S) **£45.00a**
Mysteries of Nature (Anglia) **TBA**
Naughty Stories V1&2 (Sher) **£93.00b**
PhotoBase 1920s, 30s, 40s, 50s, 60s
Victorians, Landscapes Each (LL) **£54.00a**
RiscDisc 2 (Uniqueway) **£23.00a**
Seashore Life (7-11) **£44.00a**
Understanding Energy **£53.00a**
Understanding the Body **£44.00a**
World War 2 **£28.00a**

Application Software

Advance (Acorn) **£116.00c**
Advantage (LL) **£54.00a**

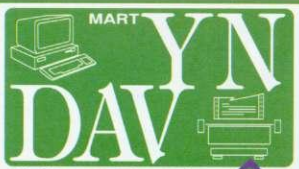

SEE US AT
Olympia Exhibition Centre
1-3 November 96

Finance

Clearly the Best Choice
(based on 20% deposit and 0% finance over 20 month period) (Acorn Items Only)

20 months 0%

Personal finance is available to qualifying purchases. Credit subject to status. Written quotation on request.

APR 0%

SEE US AT
Olympia Exhibition Centre
1-3 November 96

Acorn WORLD

STAND No. 22

Ancestry II (Minerva) **£87.00b**
ANT internet II (ANT) **£109.00b**
Apple FS (Oragan) **£30.00a**
Arcfax (David P) **£33.00a**
Armedus (Clares) **£25.00a**
ArtWorks (CC) **£99.00c**
C++ (Acorn) **£249.00c**
Card Shop (Clares) **£22.00a**
Celebration (Clares) **£32.00a**
The Comp Animator (Iota) **£93.00b**
Composition (Clares) **£150.00c**
Compression (CC) **£31.00a**
DataPower (Iota) **£99.00c**
Desktop Thesaurus (R Dev) **£19.00a**

Davyn Software

Draw to DXF Converter
NEW Only £23.00a

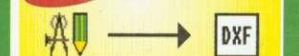

Easy Clip (Fabis) **£31.00a**
Easy Font 3 (Fabis) **£31.00a**
Eidoscope (RiscPC only) (CC) **£170.00b**
Eureka 3 (LL) **£104.00c**
Formulix (CC) **£70.00a**
Fox FX (Datastore) **£12.00a**
Frame-It 1 or 2 (Davyn) each **£6.00a**
Publisher irregular frames

Graphics Loaders (CC) **£44.00a**
Illusionist (Clares) **£45.00a**
Image FS 2 (Alternative P) **£41.00a**
Image Outliner (Iota) **£54.00a**
Impression Publisher (CC) **£139.00c**
Impression Style (CC) **£79.00c**
InterTalk (Acorn) **£92.00c**
Knowledge Organiser 2 (Clare) **£72.00a**
Notate (LL) **£62.00b**
PC PRO (PC386 v.2) (NEW ANT) **£45.00a**
Pendown Etioles (LL) **£58.00c**
Pendown Plus (LL) **£83.00c**
Personal Accounts (Apricote) **£40.00b**
PhotoDesk 2 (Space Tech) **£259.00c**
Pinpoint (Longman) **£104.00a**
Pro Artisan 2 (Clares) **£159.00a**
Pro Artisan 24 (Clares) **£99.00c**
Prophet 2 Accounts (Apricote) **£163.00c**
Render Bender v2 (Clares) **£45.00a**
Replay Starter Kit (Acorn) **£40.00b**
Revelation ImagePro (LL) **£163.00c**
Rhapsody 3 (Clares) **£93.00a**
Rhythm Bed (Clares) **£45.00a**

RiscCad Professional

S/U Education (Davyn) **£199.75c**
Education **£159.80c**
Site Licence **£581.62c**
Serenade (Clares) **£93.00a**
ShapeFX (Datastore) **£12.00a**
Sibelius 6 (v3) (Sibe) **£179.00c**
Sibelius 7 Prof. (v3) (Sibe) **£899.00d**
Sibelius 7 Student (v3) (Sibe) **£499.00d**
SmArt (4Mat) **£41.00a**
SmArt Files (4Mat) each **£17.00a**
SmArt File Mod.Lang (4Mat) **£21.00a**
Snippet (4Mat) **£38.00a**
Sound FX Maker (CIS) **£39.00a**
Termite Internet (DoggySoft) **£89.00c**
TextEase (Sost/Ease) **£54.00a**
TextEase Talking (Sost/Ease) **£74.00a**
TimeCode (ART) **£29.00a**
Titler (Clares) **£93.00a**

Topographer (Clares) **£73.00a**
Touch Type (Iota) **£45.00b**
Turbo Driver (CC) **£51.00b**
Twin Drivers (DP) **£19.00a**

Education Software

10 out of 10 Full Range Each **£14.00a**
Dinosaurs, Driving Test, Early Essentials, English, Ess Maths, Ess Science, French, German, Essentials, Math Algebra, Math Geometry, Maths Number, Math Statistics, Stuct Spelling.
Adventure Playground (Storm) **£21.00a**
Amazing Maths (CSH) **£22.00a**
Amazing Ollie (Storm) **£15.00a**
Arcventure I Romans (Sher) **£38.00a**
Arcventure II Egyptians (Sher) **£38.00a**
Arcventure III Vikings (Sher) **£38.00a**
Arcventure IV A Saxons (Sher) **£38.00a**
Around World 80 Days (Sher) **£49.00a**
Aztecs (Sher) **£48.00a**
Badger Trails (Sher) **£48.00b**
Balloons and Zoo (Topo) **£21.00a**
Body Wise (Sher) **£48.00a**
Calabash Pirates (Storm) **£25.00a**
Coffee (Storm) **£29.00a**
Connections (Sher) **£34.00a**
Crystal Rain Forrest (Sher) **£48.00a**
Crystal Rain Forrest II (Sher) **£48.00a**
Darryl the Dragon (4Mat) **£21.00a**
DataGraph (Topo) **£30.00a**
Farm (Sher) **£22.00a**
First Logo (LL) **£25.00a**
First Page DTP (LL) **£53.00a**
Flossy The Frog (4Mat) **£26.00a**
Flight Path 94 (Storm) **£31.00a**
Freddy Teddy (Topo) **£15.00a**
Freddy Teddy's Adv (Topo) **£15.00a**
Fun School 3/4 (5,5,7,7+) each **£20.00a**

(Please Specify age group)

Granny's Garden (4Mat) **£26.00a**
Happy Life (CCS) **£31.00c**
James Pond running water **£29.00a**
Landmarks full range (LL) each **£28.00a**
Look Here Talking Topics (Sh) **£61.00b**
Maggie (LL) **£62.00b**
Maths Circus (4Mat) **£29.00a**
MathsMania (Topo) **£25.00a**
Music Box (Topo) **£35.00a**
Naughty Stories V1 or 2 (Sher) **£58.00b**
Number Tiles (Topo) **£25.00a**
Ollie Octopus Sk Pad (Storm) **£16.00a**
Oxford Reading Tree Stage 2 **£45.00b**
Talking Stories (Sher) **£45.00b**
More Talking Stories A (Sher) **£45.00b**
Oxford Reading Tree Stage 3 **£45.00b**
Talking Stories (Sher) **£45.00b**
Oxford Talking Infant Atlas **£21.00a**
PinPoint Junior (LL) **£31.00a**
PaintWise (Sher) **£49.00a**
Rosie & Jim Duck (Sher) **£11.50a**
Rosie & Jim Sneezes (Sher) **£11.50a**
ScreenTurtle (Topo) **£35.00a**
Sea Rescue (Sher) **£29.00a**
Selladore Tales (Sher) **£26.00a**
Smudge the Spaniel (Storm) **£19.00a**
Smudge the Scientist (Storm) **£42.00a**
Smudge Punctuates (Storm) **£TB.Aa**
Space City (Sher) **£31.00a**
Splash (Sher) **£22.00a**
Stig of the Dump (Sher) **£26.00a**
Story Starts (Sher) **£26.00a**
Talking Clock (Topo) **£35.00a**
Talking Animated Alphabet **£32.00a**
Talking Rhymes 1 (Topo) **£26.00a**
The Playground (Topo) **£25.00a**
The Puddle & Wardrobe (Topo) **£20.00a**
Time Detectives (Sher) **£49.00a**
TinyDraw/Logo (Topo) **£25.00a**
TinyPuzzle (Topo) **£20.00a**
Teddy Bear's Picnic (Sher) **£31.00a**
Voyage of Discovery (Sher) **£38.00a**
Worst Witch (Sher) **£29.00a**

Games Software

Alderbaran (Evolution) **£10.00a**
Alone in the Dark (Krisalis) **£25.00a**
Aries 4games (GamesWare) **£25.00a**
Anagram Genius (4D) **£27.00a**
Big Bang (Psycore) **£14.00a**
Black Angel (4D) **£28.00a**
Boxing Manager (Krisalis) **£5.00a**
Burn Out (Oragan) **£23.00a**
Cannon Fodder (Krisalis) **£23.00a**
Chuck Rock (Krisalis) **£10.00a**
Cobalt Seed (TBA) **£21.00a**
Crystal Maze (Sher) **£27.00a**
Cyber Ape (TBA) **£17.00a**
Cyber Chess (4D) **£28.00a**
Darkwood (Eclipse) **£22.00a**
Dune2 (Eclipse) **£32.00a**
Dune2 CD (Eclipse) **£45.00a**
Dungeon (4D) 2mb **£29.00a**
Empire Soccer (Empire) **£23.00a**
Enter The Realm (4D) 2mb **£21.00a**
E-Type Compendium (4D) **£22.00a**
E-Type Jaguar 2 **£29.00a**
£21.00a
Fire & Ice (US Gold) **£25.00a**
F.T.T. (TBA) **£17.00a**
Global Effect (Eclipse) **£32.00a**
Gods (Krisalis) **£10.00a**
Haunted House (4D) 2mb **£22.00a**
Heimdall (Krisalis) **£15.00a**
Hero Quest (Krisalis) **£15.00a**
Holed Out Compendium (4D) **£21.00a**
James Pond (Krisalis) **£10.00a**

James Pond 2 RoboCod (G/W) **£20.00a**
James Pond running water **£29.00a**
Krisalis Collector (Krisalis) **£24.00a**
Lemmings (Krisalis) **£19.00a**
Lemmings Oh No More (Sob) **£15.00a**
Lemmings RiscPC (Krisalis) **£24.00a**
Magic Pockets (Sob) **£15.00a**
Man United Europe (Kris) **£10.00a**
Populus (Krisalis) **£25.00a**
Quest for Gold (Krisalis) **£5.00a**
Revolver (Psycore) **£14.00a**
Real McCoy 2 (4D) **£29.00a**
(Apoalypse, Holed Out, Olympics, Inertia)
Real McCoy 3 (4D) **£29.00a**
(PowerBand, Newborn, Drop Ship, The Wing Game)
Real McCoy 4 (4D) **£29.00a**
(Galactic Dan, Grievousboddy Arm, X-Fire, Cautious)
Sally & Wally (Sob) (Oragan) **£15.00a**
Saloon Cars Deluxe (4D) **£29.00a**
Scrabble (US Gold) **£25.00a**
SimCity (Krisalis) **£26.00a**
SimCity 2000 (Kris) A5000/PC **£33.00a**
Simon The Sorcerer (G/W) **£35.00a**
Simon The Sorcerer CD(G/W) **£41.00a**
Small (Sob) (Virgo) **£15.00a**
Speedball (Sob) (Krisalis) **£15.00a**
Spobbleid (Sob) (ibernation) **£5.00a**
Spobbleid Fantasy (4D) **£27.00a**
Starfighter 3000 (Fednet) **£27.00a**
Stereworld (4D) **£27.00a**
Stunt Racer 2000 (4D) **£29.00a**
Swiv (Krisalis) **£10.00a**
Time Machine (4D) **£23.00a**
Virtual Golf (4D) 2mb **£29.00a**
Virtual Golf augusta course (4D) **£20.00a**
Zool 1.6m disk (Sob) (AP) **£8.00a**
GamesPad 2player (G/W) **£33.00a**

Special Clearance Offers

subject to availability
5.25 40k bare disc drive **£19.00c**
8bit User Analogue Interface **£23.00b**
A Mouse in Holland (EY) **£20.00a**
Amazing Maths (EY) **£17.00a**
Doris the Dotty Dog (EY) **£10.00a**
Flossy the Frog (EY) **£20.00a**
Gemini (EY) **£10.00a**
Polyminoes (Topo) **£25.00a**
Podd (ESM) **£15.00a**
Prime Mover (Minerva) **£30.00a**
Pro Driver (Acc) **£15.00a**
StartWrite (AP) **£8.00a**
StartWrite Talking (EY) **£15.00a**
Waiter (Digital) **£15.00a**
Word Works (CC) **£15.00a**
Master Compact Games Various **£3.00a**
New & Used Acorn Spares **£ ring**

How To Order

Cheques: should be made payable to Davyn Computers

Credit Cards: you may also pay by Visa, Delta, Euro, Switch, Electron, or Master Card. We normally make no charge for this, and take no payment until goods are ready for dispatch. We need the card holders address and telephone number, card number and issue number if any and the expiry date.

Carriage: charges are as follows
a Small **£1.25**
b Medium **£2.50**
c Medium Recorded **£4.50**
d Courier **£10.00**
e Courier Large **£15.00**

Official Orders: are welcome from UK education and government institutions (invoices are due for payment within 14 days and are subject to carriage and late payment charges).

VAT is

Cover disc

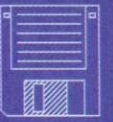

Inferno

Paradise



It's a race against time to damp down the nuclear core that's going critical by passing over it and spraying it with your craft's special extinguisher. Once the area has been cleared the teleporter must be found to exit to the next level.

Along the way you will encounter the plant's service robots, security robots and defence systems which will have to be overcome. Different units are known to behave in different ways to intruders.

Power-ups such as lasers, a booster, better extinguishers, shields and coolant may be collected to enhance the craft. There are many bonus objects and you'll have to find out what they do yourself.

Controls

You can set the keyboard or joystick controls from the main menu but once in the game you also have:

- F1 Pause game
- F2 Display area map
- F3 Abort mission

Power-ups

Electron shield which gives your craft a short period of invincibility.

Area coolant jar cools the immediate area giving a little more of the precious time needed to complete the mission.

Turbo thruster upgrade so you can move faster.

Plasma laser upgrade gives the craft even more powerful blasts that can travel through solid objects, only three can be carried at any one time.

Coloured keys activate and deactivate security beams of the appropriate colour, when lit the key display shows that the corresponding security beams have been deactivated.

Hints and tips

- All the core in an area must be extinguished before the teleporter becomes activated.
- Attempt to find the most effective route through each area to save time.
- Learn how to outwit droids and robots in the plant.
- Save the area coolant jars and extra energy cells until they are really needed.
- Avoid collecting multiple plasma laser upgrades as you can only store three of them.
- Use electron shields wisely.

Inferno is a budget game and you can get the full version for just £9.99 (cheques payable to *David Flynn*) from Paradise, 12 Kings Close, Longburton, nr Sherborne, Dorset.



Stephen Harrison

Processor Vector Module

The purpose of this small module is to add a new, very useful SWI to the operating system. This SWI is &69,OS_ClaimProcessorVector, and allows programs to 'legally' take over the hardware vectors handled by the processor, such as the SWI vector and abort vectors.

This SWI is available in RISC OS versions 3.5 and later, but users of RISC OS 3.1 and RISC OS 2 cannot easily duplicate its function and are left to fend for themselves – this usually results in incompatible code being created which will not work on newer

machines, and causes many problems.

The details of SWI OS_ClaimProcessorVector can be found in Volume 5 of the RISC OS 3 PRMs, and are duplicated in the 'SWIdetails' file with this module on the cover disc.

Disc information

The software on these discs has been compressed using *ArcFS 2* from VTi, and are opened by running a copy of *ArcFS* then double-clicking on the archive to open it. There is a copy of *ArcFS* on each disc.

Most software will run straight from the archive, but some programs may need to be copied out of the archive before being run, uncompressing them in the process. Any program that saves a file to disc, for instance, will be unable to do so into the archives on the disc.

Faulty disc?

If your disc is faulty, test whether it will verify by clicking with Menu on the floppy drive icon and choosing Verify. If it fails to verify or is physically damaged you should return it to *TIB, TIB House, 11 Edward Street, Bradford, Yorkshire BD4 7BH*. If it verifies successfully return it to the *Acorn User* editorial office at the usual address.

The *Acorn User* cover disc has been checked for viruses using *Killer* version 2.401 from Pineapple Software.



Cover disc

Flashback music

Stephen Harrison

This program was written in response to a plea in the software request section of the excellent *Acorn User* PD column in the July '96 *Acorn User* magazine.

Background

Anyone who has played the Acorn version of *Flashback*, and has seen the versions available on the Amiga and PC will have noticed there is a big difference in the music. The original Amiga version of *Flashback* has excellent music, sound, graphics and game-play. The Acorn conversion has equal gameplay and better graphics (VGA support) but is sadly very lacking in the sound department – which just happens to be one of the most important parts of this game.

An example of the poor playing of the music in the Acorn version is the background music to the loading intros. If you have not seen the other versions you won't know that the US Gold title page is meant to appear in time to music, not seemingly randomly to a buzzing noise, as in the Acorn version.

The cause of the problem is the music player. The play routine used in the Acorn version of *Flashback* was probably written by the game's author – which is always a bad sign, games authors should stick to games, and let music player authors handle the music.

Solution

Luckily all is not lost. The music files stored in the *Flashback* game, although altered, still contain most of the original data from their original ProTracker format, and with a little effort can be converted back to their original glory.

This program, *!FBackQTM*, does just this, and converts all the music played in the game, while it is running, into their original ProTracker format – fixing badly converted effects and volumes as it goes, and sends the results to the best ProTracker music player available for your computer, QTM, Q The Music.

Jingles in the game, although much more altered in the Acorn version, are converted back to ProTracker format too, and are played by QTM using its *transparent sound system* which allows *Flashback's* sound handler to play all the sound effects through the

music as well.

The result is a much better game. *Flashback's* intro sequences are now perfectly timed to the music just as on the Amiga, and the whole game benefits from in-tune music, with much better timing and synchronisation.

How to use !FBackQTM

To play *Flashback* with the new, correct, high quality sound simply run this application, then run the *Flashback* game! Hard disc users can simplify this even more by copying *!FBackQTM* into the same directory as *!Flashback*, double-clicking *!FBackQTM* will then load the patch and run the game as well.

Note: This program only alters memory contents and does not modify any files in the *Flashback* game, so it won't alter your original discs.

Apologies to 1Mb users, deeply sorry guys, this won't run on 1Mb. Well it will run, but *Flashback* won't run with it, if you see what I mean. Maybe you should consider getting 2Mb? But if you've managed to survive so far with only 1Mb, you probably don't need two.

This program will definitely run on RISC OS 3.0 and above, but has not been tested on RISC OS 2, as my RISC OS 2 test-computer only has 1Mb, but it should run. If it doesn't I will release an update to do so as soon as someone tells me about it.



IBrowse

David Thomas

IBrowse is a Sprite and JPEG image viewer for RISC OS computers equipped with the SpriteExtend module version 0.99 or later. This version of the module is built into RISC OS 3.6 and is available as a soft-loadable module for RISC OS 3.5 machines.

IBrowse was created to run in as little memory as possible, for this reason it doesn't provide some of the less-used features of image viewers such as scaling the view, 'slideshow' etc. However, it does support app-to-app transfer of images and performs excellently in its capacity as a fast way to view images.

Drag a Sprite or JPEG file to the *IBrowse* icon bar icon. A window will open displaying the file. Also, double-clicking on a Sprite or JPEG file when *IBrowse* is loaded will load it.

In addition to the standard Info and Quit entries on the icon bar menu, there is also a 'Choices...' entry which, when selected will open the choices window which allows you to set the types of dithering used on the display:

Sprite Choices

• *Simple dithering* uses a simple patterning technique in most modes which helps lessen

the banding effect you get when you display deep sprites in paletted modes. My preference is to leave this option off, as it seems to make sprites look worse in certain cases. (Note that the patterning technique will not always appear immediately on the display. Sometimes a change of screen mode is needed to 'kick' it into action.)

• *Load on double-click* will make *IBrowse* respond to double-clicks on sprite files, which it will automatically load. This option is off by default as most sprite files will have more than one sprite in them and *IBrowse* will only display the first.

JPEG Gathering

• *No dithering* performs no dithering so the image may look banded in 256 and less colour modes. However, it is the quickest display method.

• *Simple dithering* uses a simple patterning technique in most modes which helps lessen the banding effect.

• *Error diffusion* is the slowest display method but provides a much better quality of display. This method only works for 256 colour modes, in other colour depths this is

equivalent to Simple. It is the default. It is worth noting that even with error diffusion, in paletted modes the display quality will never be as good as that produced by ChangeFSI. Use ChangeFSI if you're converting an image permanently to a sprite.

A menu is available from the display window which allows you to open the Choices window as outlined above, also it allows you to access an information window which provides details about the image such as the resolution and depth.

IBrowse will use a Dynamic Area for storage of the image and is compatible with Clare's *Virtualise* package. Information on obtaining the module can be found in the *IBrowse* help file.

Regular items

- Mike Cook's audio channel selector
- Steve Mumford's Wimp C series creates a simple database application
- David Matthewman's HTML page examples



<http://www.anglia.co.uk>

Anglia Multimedia CD ROMs

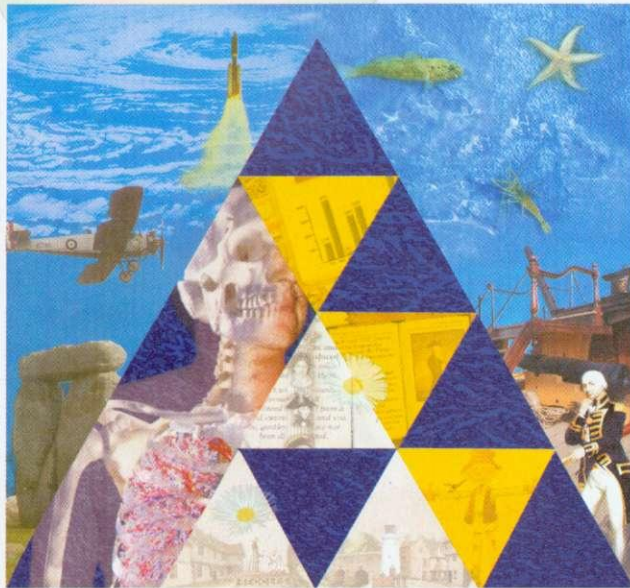

**In touch with
children's learning**

**Visit us on stand 122
at the Acorn World Show**

All titles available for
Acorn, PC and Macintosh™

Art Store - Looking at Animals

Exploring Castles

Garden Wildlife

British Isles from the Air

Seashore Life

Industrial Revolution

Understanding Energy

Understanding the Body

The World's Weather

Vikings!

Nelson and his Navy

NEW

Romans

Being a Scientist

Eureka: An Encyclopædia
of Inventions and Discoveries

Survival's Mysteries of Nature



ANGLIA
Multimedia

Telephone / Fax 01268 755811

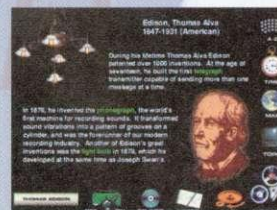

SCA (Anglia Multimedia), PO Box 18, Benfleet, Essex SS7 1AZ

Acorn World 1996

Prepare to be excited
OLYMPIA 2

November 1-3

The time is coming for Acorn enthusiasts everywhere, for the show featuring everything and everybody crucial to users of the hottest system in computing development!

Experience...

the far-flung horizons of the Internet with leading Acorn service providers
state-of-the-art seminars on publishing, home & school computing and specialised communications technology
new product launches and updates from all major Acorn developers

See, try and, YES, you can buy...

revolutionary 'StrongArm' card, delivering ultimate speed and processing power
new Pentium-capacity Risc PCs
network computers and Oracle set-top boxes from ART
innovations in software and developments in DPT education, music, art & design and home computing

Over 100 exhibitors will combine to make this the biggest, best Acorn World yet. All your old friends and some new ones will be there, many offering sensational discounts.

For fast track entry and early access at the weekend order your tickets now and save:
£5 adults (£7 on the door). £16 families - 2 adults with children - (£20 on the door). £4 under 16s (£5 on the door)

• Don't miss out...

• Exhibition Times

10.00 - 18.00 Friday 1 & Saturday 2 November
10.00 - 17.00 Sunday 3 November

• Advance booking Hotline 0701 0709 909

• Travel & accommodation deals, tel: 0171 372 2001 (Event code Acorn '96)

• Acorn World Website: <http://www.eps-events.com/acorn-world>

• CRECHE • EASY TRAVEL • AMPLE, EASY PARKING • CARRY OUT PURCHASE SERVICE

Sponsored by

ACORNUSER

Supported by

**Xemplar
and A.R.T.**



Stand 160
Acorn World
Show

0%

Finance on Risc PCs



Upgrade to a New Risc PC



Buy with confidence from Beebug, voted "1995 Best Dealer" by readers of Acorn User. BEEBUG is Acorn's largest dealer and is an Acorn Centre of Technology

New Low Prices

- Risc PC600 4Mb HD540, with AKF60 monitor . . . £1299.00
 - Risc PC700 5Mb HD540, with AKF60 monitor . . . £1549.00
 - Risc PC700 10Mb HD 1Gb, with AKF60 monitor . . £1799.00
- 12 months on-site warranty included.

Extras:

- 17" Acorn AKF90 Monitor - Add £400.00
 - 17" VisionMaster Pro - Add £405.00
 - Quad Speed CD ROM - Add £99.00
- 0% APR credit is available over 20 months.
Please call for written details.

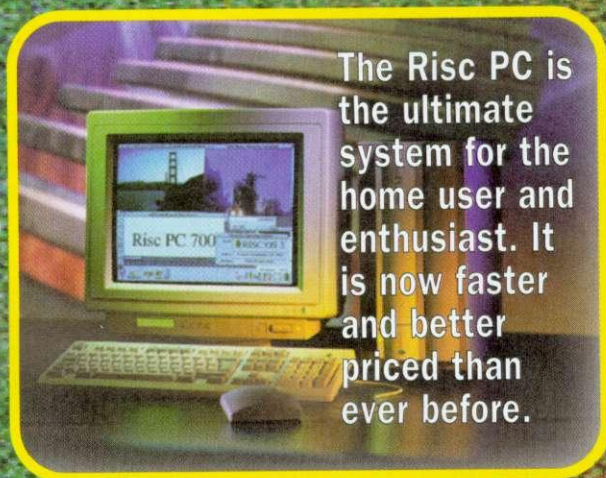

The Risc PC is the ultimate system for the home user and enthusiast. It is now faster and better priced than ever before.

StrongARM ONLY £116.33

When you buy any Risc PC

Support From BEEBUG

Our Acorn support staff are second to none

Trade In Your Existing System

Attractive trade in discounts for your existing Acorn system, call for details. Your data and upgrades will be transferred to your new system at no charge



Special Offer

Choose from either:
Ovation DTP

(RRP £81)

or

12 months
RISC User
Magazine
& Disc
Subscription
(RRP £72.50)

BEEBUG Ltd., 117 Hatfield Road, St Albans, Herts AL1 4JS
Tel: 01727 840303 Fax: 01727 860263 Email: sales@beebug.co.uk

All prices include VAT



Acorn World '96

This year's Acorn World is really something to look forward to. There's been so many changes over the last year and there's now so much to look forward to that it's sure to be a busy and exciting few days. For a start, the location has changed. This year, Acorn World is to be held at Olympia 2 from

November 1-3. Over the next few pages you'll find details of how to get to the exhibition, as well as a preview of what's happening. There's a stand guide, floor plan and details of theatre presentations, seminars and demonstrations. Everything you need to plan your day at Acorn World 1996.

Getting there

London

Underground: Take the District or Piccadilly Line to Earls Court. A connecting District Line service operates from Earls Court to Olympia at 10-15 minutes intervals.

Bus: Olympia 2 is on several bus routes Zone 1. The numbers 9, 9A, 10, 27, 28 and 49 will get you there.

Rail:

Adjoining Olympia is Kensington Olympia rail station which provides an Inter-City link for fast through train services between Manchester-Birmingham-London-Gatwick-Brighton-Dover. The North London Line also provides a link from Clapham Junction Kensington Olympia Willesden. Main line stations are linked to Earls Court Olympia by the underground network.

Car: If you're driving to the show Olympia is close to the M3, M4, M25 and M40/1. Via the M25 there are connections to the M1, M2 and M11. There are several car parks at Olympia in which you can pre-book a parking space. These need to be booked at least 7 days in advance of the event using your Access or Barclaycard. Freephone 0500 845800.



cause. Prizes have been kindly donated by exhibitors at Acorn World. And if that isn't tempting enough there's one StrongARM upgrade to be won each day.

Innovation, Education & Entertainment

Acorn World organisers EPS Events have received an overwhelming response from exhibitors wishing to launch new products at the exhibition. "There is more innovation in this year's show than at any previous event" said Stephen Bozdan of EPS.

Acorn RISC Technologies

At the centre of the new developments is ART, whose introduction of the superfast new StrongARM card has provided the computing power to drive many of the new applications. ART will be demonstrating the new processor in Risc PCs on the stand and will be presenting StrongARM upgrades as competition prizes every half hour throughout the show.

A complete SA-equipped Risc PC will be presented to the winner of a 'Lucky Key' competition run in conjunction with Byte magazine, and show sponsor *Acorn User* will have StrongARM upgrades among the many lucky dip prizes. For those not lucky enough to win one, StrongARM will be on sale to the public for the very first time from the Centres of Technology exhibiting at the show.

The new NetStation computer is now a reality, and production models rather than technology prototypes will be available for trial on the ART stand (85), centrally located and shared with Xemplar on the ground floor of Olympia 2. A prototype of 'Newspad', described as a personalised electronic newspaper with A4 touch-screen technology, will also be on show. Members of the ART team will be on hand throughout the exhibition to answer enquiries and demonstrate the new products.

Theatre programme - Education

On Friday November 1 - 'Education Day' - the theatre will be dedicated to a series of seminars aimed at educational visitors, teachers and schools IT buyers, and a balance between primary, secondary and special needs subjects has been achieved.

Most speakers are either involved in mainstream education, or have been 'front-line' IT teachers.

Theatre programme - Developers

On Saturday November 2 and Sunday November 3, the exhibition is 'handed back' to Acorn's enthusiastic band of home, professional and specialised users. A wide range of topics and demonstrations cover DTP and graphics; music making and publishing; statistics; the Internet and a new application which renders the Risc PC capable of running more software than any other commercially available desktop machine.

Saturday will see five of the leading 'players' in Acorn DTP - Mike Williams of Akalat Publishing; Tony Tolver of T-J Reproductions; Richard Lambley, Editor of *Land Mobile* magazine; Trevor Hutton, DTP Professional of First Impression; Majid Anwar of Alternative Publishing - presenting everything you need to know about using Acorn RISC OS computers in design, software, layout and imagesetting/printing.

Geoff Titmuss of Softease will be demonstrating the very latest version of the acclaimed DTP software - *Textease* - called *Multimedia Textease*. Learn how to lay out pages and incorporate text, images, sound and Replay films.

Sibelius is known throughout the world as the finest music publishing software available. Jo McCulloch of Sibelius will be demonstrating all the versions including the latest feature - Flexi-time which allows *Sibelius* to use MIDI to input and notate what you play.

'More software for RISC OS than for

The Acorn User stand

Acorn User is in its thirteenth year and is still the best selling Acorn magazine in the world. They'll be a selection of back issues as well as the latest issue on sale. We'll also have *Acorn User* binders to keep your collection in - so why not treat yourself? Make our stand your first stop, meet the team and if you're not already a subscriber it's your chance to sign up and take advantage of our special show subscription offer. See us on stand 92.

AU Lucky Dip - Stand 218

Feeling lucky - then make your way to the *Acorn User* lucky dip stand. Each turn is £1, then just dig deep into the tub - there's a whole host of prizes, big and small, to be won. All money is going to the Great Ormond Street Children's Hospital Fund, so come along and support this worthy



The Acorn User's stand 92



Great Ormond Street Children's Hospital Fund



'96 Show Guide



Whale watching



Cybercafé



Crèche

Windows' is the bold claim from ARMEDForces Software who will be launching *WINRisc*. Chris Claydon will be showing how PC software can be used in the RISC OS desktop environment, as long as you have a PC card or podule installed.

Chris Cox of ART will be presenting StrongARM - its history, the upgraded operating system, installation, in fact, everything you wanted to know about StrongARM but were afraid to ask.

Dave Clare, that stalwart of the Acorn community will be presenting PCA - Plug-in Compliant Applications. This is not limited to Clares products and is being supported by various Acorn developers. It allows conforming applets to be 'plugged' into any conforming application. Dave will also be demonstrating Wimp Basic - a programming environment that allows quick and easy creation of WIMP applications. Both segments will be of interest to the user and programmers among the Acorn flock.

Mark Perry of Oregon Developments will be demonstrating *ProSound* and *CineWorks* software packages as well as their own (and others) hardware packages. All are designed for the latest in Digital Audio and video editing.

One of the longest established software houses is Serious Statistical Software and Robin Edwards will be demonstrating the latest versions of

the only true statistical software available to users of RISC OS machines. SSSs market is predominantly schools, but there are also users in universities and colleges as well as many NHS hospitals.

Lyndon Couch of Beebug will be demonstrating some (if not all) of the amazing features of *OvationPro* - some features will be unveiled for the first time at Acorn World.

Dalriada have developed many useful applications over the last few years and George Buchanan will be introducing *Spider* - a new WYSIWYG-ish HTML Editor as well as the latest version of *TableMate* - *TableMate Designer*, which does for WWW Internet pages tables what the original did for paper based publishing.

Ever seen any of Walter Briggs 'painting' creations? Want to know how it was done? Here is your chance - Walter Briggs will be demonstrating how to use *Studio24Pro* from Pineapple Software. Come and see the 'Master' at work.

ESP and Dr Andy Pierson will be showing the latest in sound processing using a StrongARM-equipped Risc PC. They will also be presenting updates and extensions to Synthesiser. Interested in MIDI? Andy expects that ESP will have a school based product ready to both demonstrate and sell.

Other features

Parents with young and school age children are not forgotten at AW96. Dr Maggie Holgate and her colleagues at the 'Parents' Information Network (PIN) will have a stand at the show, and they will be presenting a seminar on using computers at home with young children. While important now, with the increasing use of computers with ever younger children at school, this will become vital as the spread of the network computer puts IT in every home in the land.

Whale watching

The 'TIC.TOC' project, supported by Acorn and BT Campus World will enable visitors to the exhibition to link up live to schools taking part in a remarkable worldwide adventure. The name is derived from the title: 'The International Challenge - Tropic of Cancer', and it is an 18 month expedition around the world involving children in the 18 coun-

Exhibition times

10.00 - 18.00 Friday 1 & Saturday 2 November
10.00 - 17.00 Sunday 3 November

Buying tickets

Adults: £5 advance, £7 on the door
Children: £4 advance, £5 on the door
Family: £16 advance, £20 on the door
Advance booking hotline: 0701 0709 909

tries visited in environmental and wildlife projects, and encouraging them to raise money by sponsorship in support of cancer charities.

The epic journey will have started in October, and the expedition's vessel the *Creightons Naturally* will be well into the first project, tracking the migratory movements of sperm whales, aided by Dominican school children using IT equipment supplied by Acorn. Visitors to AW96 will be able to link up to the expedition and talk on the Internet to the expedition members and the schoolchildren as they follow the whales.

Cybercafé

No Acorn World can take place without a Cybercafé, now a regular feature, and often the first 'hands-on' contact with the World Wide Web for many visitors. With so many new Internet applications being demonstrated and launched at the show, this year's Cybercafé will be an interesting experience for novices and old WWW hands alike.

Crèche

Popular demand has ensured that the crèche facilities will be offered for families with children too young to take an interest in the exhibits, or just too tired to 'keep on truckin'', and Olympia's extensive restaurant facilities and rest areas should ensure a more relaxed event for all.

As this article went to press, more developers were contacting the organisers with news of innovations for the show. Watch the AW96 website on <http://www.eps-events.com/acorn-world> for the very latest information.

Education Day theatre itinery

- Friday November 1st
- 10.30 - A School's IT Framework - Dick Wallin - Xemplar - Primary/Secondary
- 11.30 - IT in Special Needs - Paul Nuttall - SEMERC - Primary/Secondary
- 12.30 - Managing IT across the Curriculum - Alastair Wells - Secondary
- 13.30 - StrongARM for the Risc PC - Chris Cox - ART - Primary/Secondary
- 14.30 - Pe-School IT - Paul Nuttall - SEMERC - Primary
- 15.30 - The Community Superhighway - Alastair Wells - Primary/Secondary
- 16.30 - Primary Networking - Alan Bennett - Xemplar - Primary





Stand Guide

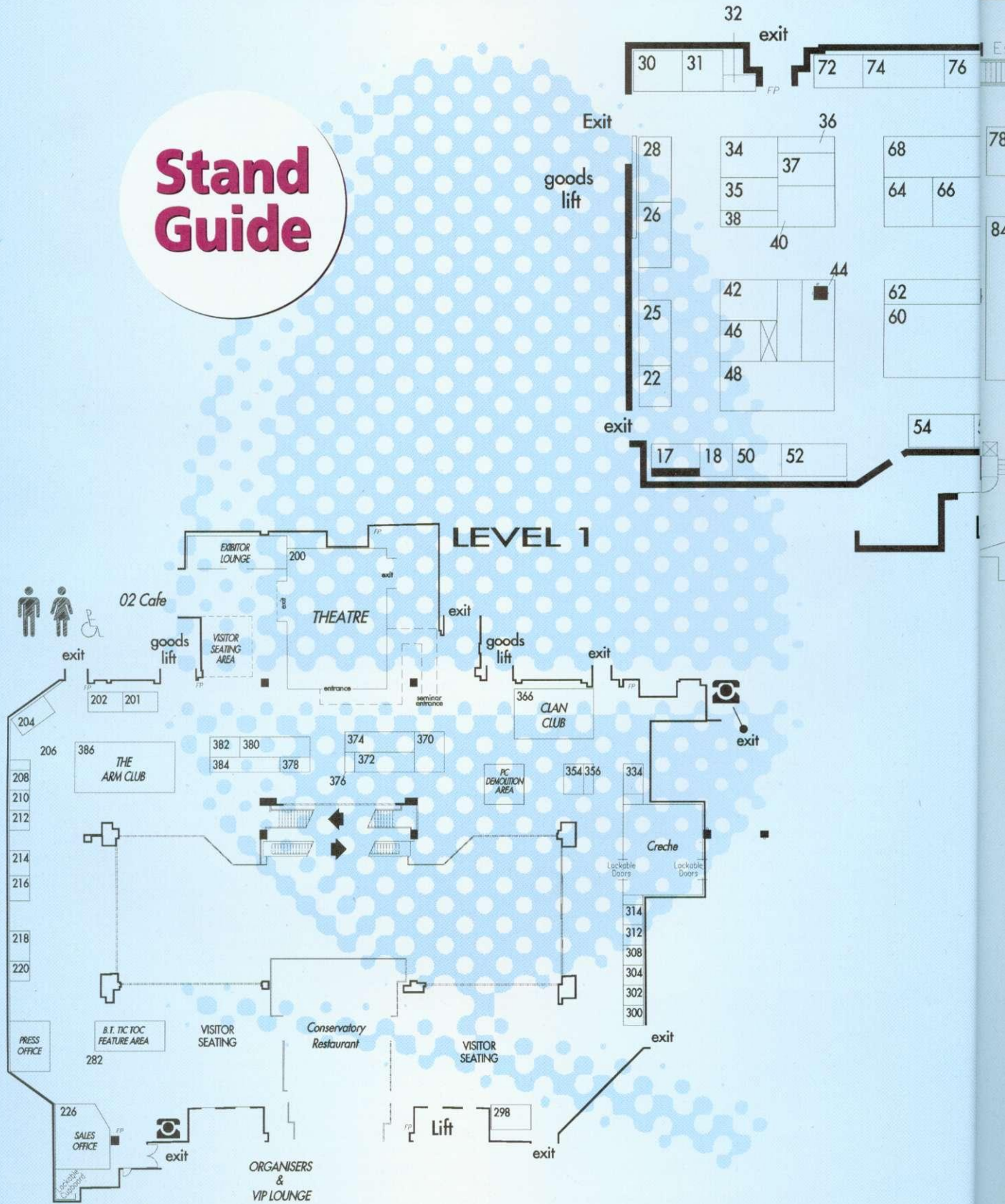

LEVEL 1



Acorn World '96 Show Guide

Escalator up to Level 1
Stairs to/from Level 1

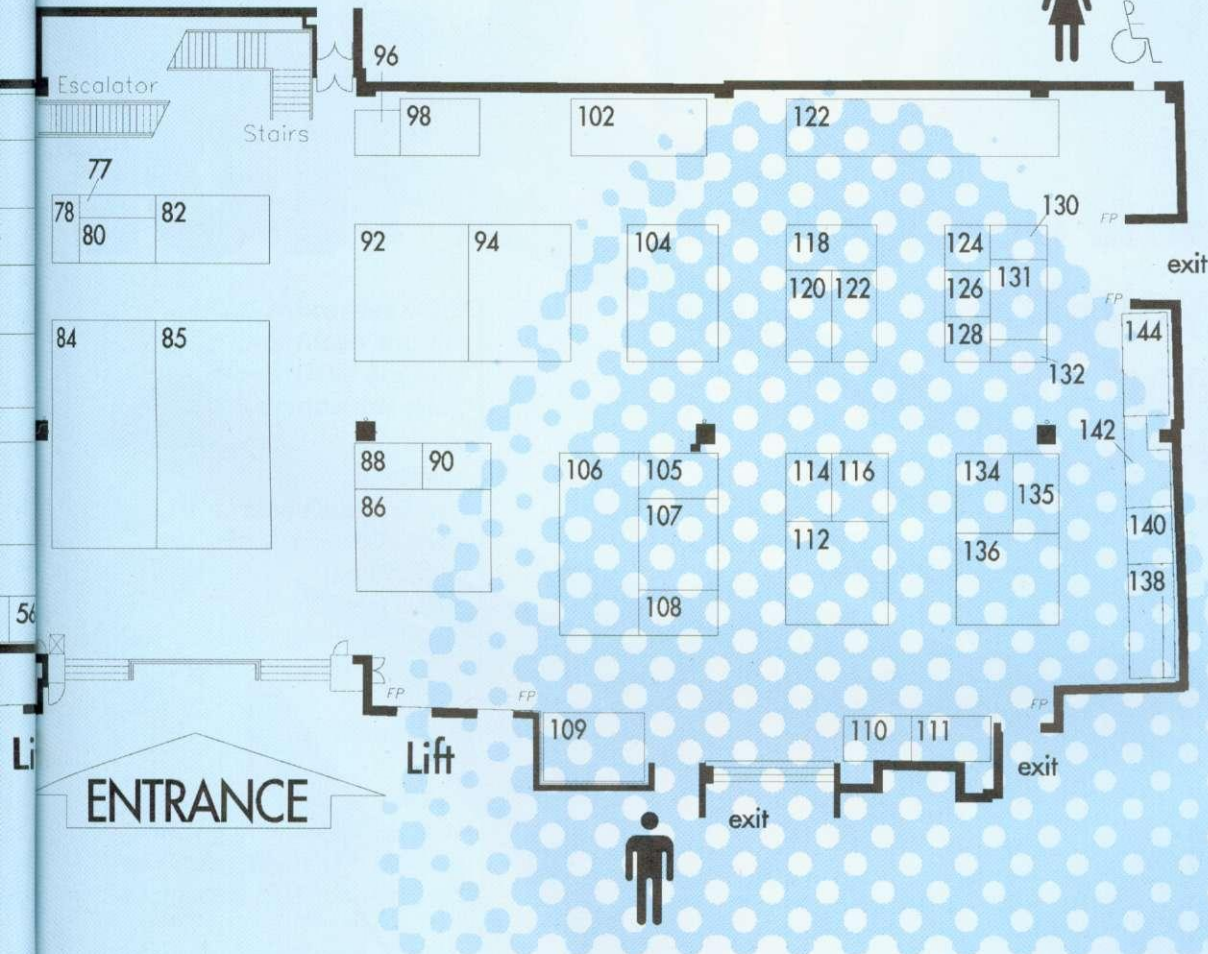

List of exhibitors

4th Dimension	354	Circle Software	50	Q-Tec Technological Resources	370
10 Out of 10	354	CJE Micro's	26	Quill Marketing	72
Abacus Training	116	Clares Micro Supplies	48	R-Comp	96
Acorn Archimedes World	74	Colton Software	116	RE at Lampeter University	376
Acorn User	92	Computer Concepts Ltd	106	Resource	78
Acorn User Lucky Dip	218	Cumana	52	SEMERC	120
AJS Computers Ltd	206	Dalriada	114	Serious Statistical Software	32
Akalat Publishing	124	Davyn Computer Services	22	Sherston Software Limited	86
Aleph One Ltd	94	Desktop Projects	40	Sibelius Software	42
Alsystems	68	Doggysoft	80	Simtec Electronics	66
Alternative Publishing	90	Eonomatics Education	110	Smart DTP	126
Anglia Multimedia	122	Eesox	134	Softease	378
ANT Ltd	94	Electronic Font Foundry	18	Spacetech Ltd	88
APDL	28	ESP	46	System Insight	44
Apricote Studios	77	ExpLAN	109	TBA Software	138
Archive	62	Fabis Computing	132	The ARM Club	386
ArgoNet/Eclipse/VTi	102	Icon Technology Ltd	64	The Datafile	17
ARMed Forces Software (AFS)	384	Insight Training	201	The Datastore	111
ART	85	Iota Software Ltd	38	The Guardian Newspaper	112
Atomwide Ltd	94	Irlam Instruments Ltd	98	Uniqueway	56
AVP	54	Kimberley Computers Ltd	76	Warm Silence Software	36
Beebug	60	KITT	105	Wyddfa Software	376
BT Tic Toc	282	Management Graphics	25	Yellowstone Educational Solutions	107
Caiti Software	376	MCS	370	Xemplar	84
Cambridgeshire Software House	128	Oregan Developments	34	YITM	104
Castle Technology	82	Pineapple Software	118	Zenta Multimedia	130

Now fully StrongARM™ and RISC OS 3.7 compatible.

Power for

Available from
Alsystems
Stand 68
Acorn World

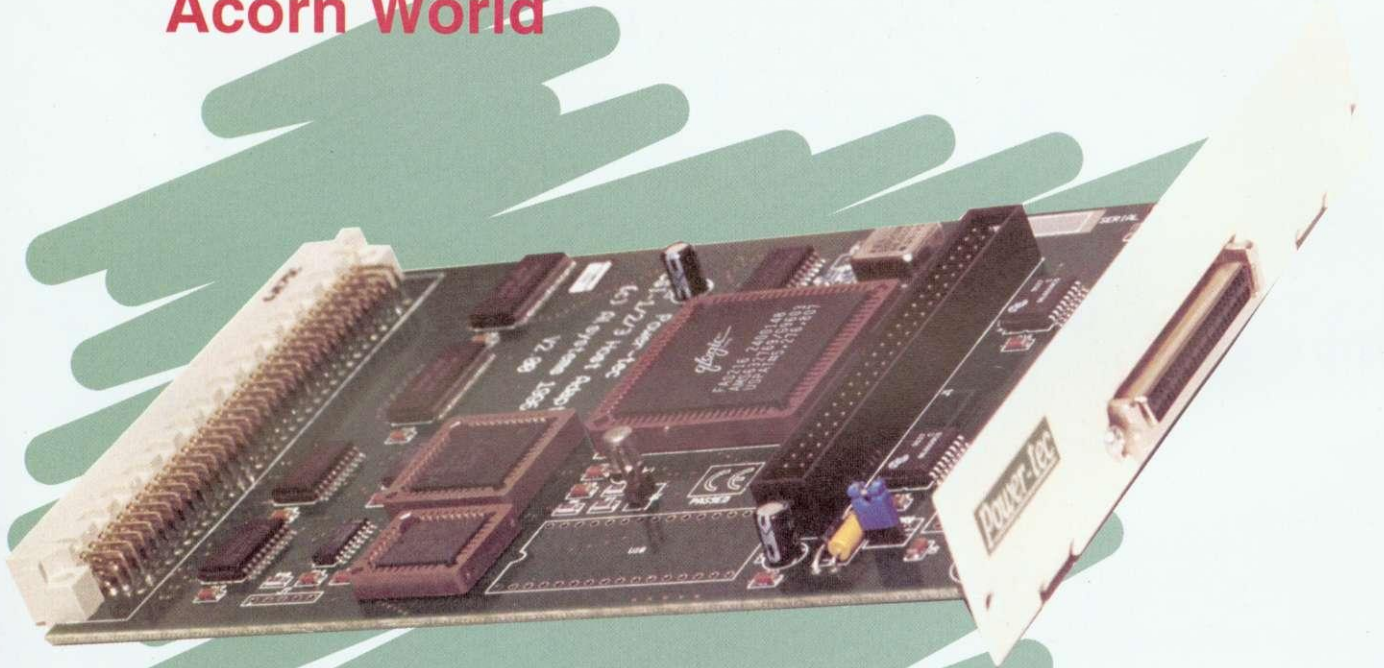

£175

32-bit DMA Transfers
Direct DOS Formatting
Create **16 GB** partitions
with RISC OS 3.6/3.7

Power-tec

**Fast
SCSI II**

*" No other SCSI card
has the functionality
of the Power-tec Fast SCSI II "*

*"The Power-tec SCSI Software
is a model of how things should be."*

Power-tec

Performance

**All Power-tec SCSI
interfaces and the
PowerROM are fully
compatible with:**

Zip Drives
Jaz Drives
Mag Optical Drives
Panasonic PD Drives
(eg Proteus)
Syquest Drives
5¼" - 44MB, 88MB & 200MB
3½" - 105MB & 270MB
EZ135
and Nomai Drives

ALL sizes of hard discs of ALL
leading manufacturers such
as Fujitsu, Quantum, Conner,
Micropolis, IBM and Seagate.

Scanners from Epson, Canon,
Umax, Mustek, Microtek and
other leading brands.

Includes SCSI CD Drivers for
NEC, Pioneer, Plextor, Aiwa
Toshiba, Sony, Sanyo &
recordables too!

And ATAPI Drivers for ALL
leading makes up to 8x as
well as the new Power-tec
4x4 CD Multi-Changer drive.

**PLUS - Backup Software,
8 drive icons on the icon
bar, drive spindown,
configurable LFAU,
16GB Partitions
etc... etc ...**

NEW

for ACORN WORLD 1996

If you have an old SCSI Card from these manufacturers
**Cumana • Castle Technology • Lingenuity
Morley • Acorn • Vti • HCCS • Oak**
and want to keep it with its existing features and yet have all
those benefits that Power-tec SCSI Card users enjoy,
then you need

POWERROM™

the latest addition to the Power-tec range from Alsystems

Only £39.95

at the show

You get the FULL SCSI 2 command set with all the
functionality and compatibility of our Power-tec SCSI 2 card
when you fit our new **PowerROM** upgrade. Simply replace
the existing EPROM on your SCSI card with the new
PowerROM and run the !PowerMgr application.

YOU DON'T EVEN NEED TO REFORMAT!

Fitting Instructions, Software Suite
(!PowerMgr, !Speed, !BackUp, CD Support)
and Ongoing Technical Support all included.
No reduction in performance of your present ROM.

email: sales@alsys.demon.co.uk

NB: All prices exclude VAT and carriage. E&OE
Please call Alsystems on 01420 561111 for more details
Alsystems, 47 Winchester Road, Four Marks, Alton, Hampshire. GU34 5HG.

Power-tec
the power to perform



The companies involved

4th Dimension

Stand 354
1 Percy Street
Sheffield S3 8AU
Tel: 0114-276 9950
Fax: 0114-278 1091
E-mail:
4D@rsenter.demon.co.uk
Bargain hunters will be happy to learn that 4D will have a large selection of their games, complimented by the 10 out of 10 educational range, on sale at unbeatable prices. Also you can find out more about our imminent move.

10/10

(See 4th Dimension)

Abacus Training

Stand 116
29 Okus Grove
Upper Stratton
Swindon
Wiltshire SN2 6QA
Tel/fax: (01793) 723347
Get the best out of *Fireworkz*, *Pipedream* or *Impression* by joining Zline, Pipeline or ILine. User group members receive a free technical help service and regular discs containing articles written by experts for experts and others written specially for beginners.

Acorn Archimedes World magazine

Stand 74
Nexus House
Boundary Way
Hemel Hemstead
Herts HP2 7ST
Tel: (01442) 66551
Fax: (01442) 66998
Acorn Archimedes World is the magazine for all RISC OS users, whether your interests lie in business, home or educational use. Each issue is packed with information and advice you cannot afford to miss.

AJS Computers Ltd

Stand 230
Millstone Houses
51/53 Heath Drive
Chelmsford
Essex CM2 9HE
Tel: (01245) 345263
Fax: (01245) 345233
E-mail:
sales@ajscomps.demon.co.uk
Memory upgrades. Hard disc upgrades. Second hand equipment. Printers. CD-ROMs. Monitor upgrades. Mice. PC Card exchanges. Computer exchanges to Risc PC. Second hand hard drives, monitors, computers, podules, printers.

Akalat Publishing

Stand 124
P.O.Box 231
Barton
Bedford
MK45 4HQ
Tel/fax: (01582) 881614
E-mail: akalat@kbnet.co.uk
The stand will feature *Acorn Publisher*, the magazine for all DTP users now in its third year of publication. On sale will be the latest issue, a full range of back issues, books on desktop and electronic publishing (the Internet), plus special offers for new subscribers. Staff will also be on hand to offer help and advice on DTP matters.

Aleph One Ltd

Stand 94
The Old Courthouse
Bottisham
Cambridge
CB5 9BA
Tel: (01223) 811679
Fax: (01223) 812713
E-mail: sales@aleph1.co.uk
Web:
http://www.aleph1.co.uk
Aleph One will be showing *IPCPro*, an upgrade to the software which controls PC second processor cards. 5x86

cards can perform up to 54 per cent faster, and VESA drivers allow more DOS games to run on the card. Also on display is Network Links for PC card network connectivity.

Alsystems

Stand 68
47 Winchester Road
Four Marks
Alton
Hants GU34 5HG
Tel: (01420) 561111
Fax: (01420) 561100
E-mail:
sales@alsys.demon.co.uk
Web:
http://www.alsystems.co.uk
Alsystems has some exciting new hardware products being released at the show. As well as the Power-tec SCSI II card, the PowerROM will be available together with hard disc drives and lots of StrongARMs. Also being released will be the NEC 4x4 CD ATAPI multi-changer with Acorn driver.

Alternative Publishing Ltd

Stand 90
30 Clyde Place
Glasgow G5 8AQ
Tel: 0141-418 0880
Fax: 0141-418 0881
E-mail: sales@alt-design.co.uk
Alternative Publishing will be releasing an update to its ever popular *ImageFS* graphics utility. Improvements include added bitmap formats, including JPEG, and vector graphic support such as Window metafiles. Also on display will be AP's specialist Acorn bureau and printing services.

Anglia Multimedia

Stand 122
Anglia House
Norwich NR1 3JG
Tel: (01603) 615151
Fax: (01603) 622191
E-mail:
angliamail@asl.com
Web:
http://www.anglia.co.uk
Exciting new CD-ROMs from Anglia this year include, *Romans*, *Survival: Mysteries of Nature*, *Being a Scientist*, and *Eureka: An Encyclopedia of Discoveries & Inventions*, 20 per cent discount on all CD-ROMs bought at the show.

ANT Ltd

Stand 94
PO Box 30
Cambridge CB2 2EG
Tel: (01223) 567808
Fax: (01223) 567801
E-mail: sales@ant.co.uk
Web: http://www.ant.co.uk
Come and surf the Internet using the ANT Internet Suite Release II. New features include an updated version of the Fresco browser based on ANT's work on the NC project, and a new version of the Marcel mail and news utility with improved support for offline newsreading and multiple mailboxes.

APDL

Stand 28
39 Knighton Park Road
Sydenham
London SE26 5RN
Tel: 0181-778 2659
Fax: 0181-488 0487
E-mail: info@apdl.co.uk
APDL will have our full range of PD software and CDs at special show prices. Plus hard discs, interfaces, and CD drives at even lower cost than usual. Even if you don't buy anything come and pick up a catalogue.

Apricote Studios

Stand 77
2 Purls Bridge Farm
Manca
Cambs PE15 0ND
Tel/fax: (01354) 680432
Version 3 of *Prophet*, the acclaimed small business accounting application will be launched at the show. *Personal Accounts* and a new version of our popular *Shares* program will also be on show. AND... don't miss our very special show offers.

Archive

Stand 62
96a Vauxhall Street
Norwich NR2 2SD
Tel: (01603) 766592
Fax: (01603) 764011
E-mail:
sales.NCS@paston.co.uk
Web: http://www.cybervil-lage.co.uk/acorn/archive/
Archive magazine, simply the best enthusiasts' magazine for Acorn computers. Articles written by enthusiasts for enthusiasts. Come and support our charity fund-raising effort. Buy second hand hardware and software - bring some for us to sell, too.

ArgoNet / Eclipse / VTi

Stand 102
Unit 1 The Shopwhyke Centre
Shopwhyke Road
Chichester PO20 6GD
Tel: (01243) 531194
Fax: (01243) 531196
Email: sales@argonet.co.uk or eclipse@argonet.co.uk or vti@argonet.co.uk
Web: http://www.argonet.co.uk or http://www.argonet.co.uk/eclipse or http://www.argonet.co.uk/vti
ArgoNet will be selling the latest version of their Internet software and the new 33.6 Voice modems from US Robotics, as well as selling CD-ROM, hard disc and zip drives plus samplers and other hardware from VTi and exciting games from Eclipse.

ARMed Forces Software (AFS)

Stand 384
38 Main Road
Littleton
Winchester
Hants SO22 6QQ
Tel: (01962) 880591
Fax: (01962) 880003
E-mail:
sales@afsoft.demon.co.uk or support@afsoft.demon.co.uk
Web:
http://www.afsoft.demon.co.uk/
AFS will be selling our major new release - *WinRisc* which seamlessly integrates Windows software on the PC card into RISC OS, so it almost becomes RISC OS software. We will also be selling our RSDFS Teleworking and low-cost networking systems.

Atomwide Ltd

Stand 94
7 The Metro Centre
Bridge Road
Orpington
Kent BR5 2BE
Tel: (01689) 814500
Fax: (01689) 814501
E-mail:
Sales@atomwide.co.uk or Support@atomwide.co.uk
Web:
http://www.atomwide.co.uk
Atomwide will be demonstrating a range of network solutions, from peer-to-peer systems with just a few stations, to comprehensive site-wide configurations including Internet access. Upgrades including High Speed Serial Cards, drives



Acorn World '96 Show Guide

and memory will also be available at special prices.

AVP

Stand 54
School Hill Centre
Chepstow
Monmouthshire NP6 5PH
Tel: (01291) 625439
Fax: (01291) 629671
E-mail: 100441.130@compuserve.com
At a special discount AVP will be selling their educational *PictureBase* CD-ROMs. This series is the largest range of integrated Acorn educational CD-ROMs available. These National Curriculum CDs will prove invaluable to anyone at primary school or studying for GCSEs.

BEEBUG Limited

Stand 60
117 Hatfield Road
St Albans AL1 4JS
Tel: (01727) 840303
Fax: (01727) 860263
E-mail: sales@beebug.co.uk
BEEBUG will be displaying *Ovation Pro* in all its glory. RISC User magazine (now in its 10th year) will be there so pick up a copy. We'll have a special demo of Audio Dynamics DMI cards, be selling computers and much much more. Our stand is definitely where it's at.

Caiti Software

(See Wyddfa Software)

Cambridgeshire Software House

Stand 128
PO Box 163
Huntingdon
Cambs PE17 3UR
Tel: (01487) 741223
Fax: (01487) 741213
E-mail: 106066.2173@compuserve.com
Our new range of early year's software will be on show including a multimedia 'Talking Book' designer. In all, there will be four new programs to see.

Castle Technology

Stand 82
Ore Trading Estate
Woodbridge Road
Framlingham
Suffolk IP13 9LL
Tel: (01728) 621222
Fax: (01728) 621179
E-mail: sales@castle-technology.co.uk

Web: <http://www.castle-technology.co.uk/>

The following Castle Technology products will be available at special Show prices: Hard Drives (SCSI and IDE), CD ROMs (SCSI&IDE), scanners (SCSI), monitors, floppy disc drives, mice, memory, computers (A3010, A4000 and Risc PC), removable (Syquest Zip etc), keyboards, backplanes, SCSI II Interfaces, IDE Interfaces, SCSI/network interfaces etc.

Circle Software

Stand 50
P.O. Box 36
Bodmin PL30 4YY
Tel/Fax: (01208) 850790
E-mail: sales@circlesw.demon.co.uk
Circle Software are featuring three new versions of their popular *Impact* database program. These include a Junior version, an upgraded version of the existing *Impact2*, and a new version having powerful macro functions for the professional user.

CJE Micro's

Stand 26
78 Brighton Road
Worthing
West Sussex BN11 2EN
Tel: (01903) 523666
Fax: (01903) 523679
E-mail: cjemicro@pavilion.co.uk
Web: <http://www.art.acorn.co.uk/cft/CJE/>

A wide range of Risc PC's and upgrades, including Fast CD-ROM drives and very well priced Risc PC and A7000 memory will be on sale. CJE Micro's will be demonstrating the 'Fastest Risc PC PC Card' available for the Risc PC, the AMD 5x86 133MHz.

Clares Micro Supplies

Stand 48
98 Middlewich Road
Rudheath
Northwich
Cheshire CW9 7DA
Tel: (01606) 48511
Fax: (01606) 48512
E-mail: sales@clares.demon.co.uk
Web: <http://www.stcoll.ac.uk/clares/>
Acorn World 96 gives you the opportunity to view the latest products for RISC OS.

Latest versions of *Composition* and *ProArtisan 24* will be on show which utilise PCA, the latest development for all Risc PC users. Come along to stand 102 and find out more.

Colton Software

Stand 116
7 Signet Court
Swann's Road
Cambridge CB5 8LA
Tel: (01223) 311881
Fax: (01223) 312010
E-mail: colton.info@prot.demon.co.uk
Colton Software are proud to present a revamped *PipeDream 4* and new updates of *Fireworkz* and *Fireworkz Pro* which take full advantage of Acorn's powerful StrongARM technology.

Computer Concepts Ltd

Stand 106
Gaddesden Place
Hemel Hempstead
Herts HP2 6EX
Tel: (01442) 351000
Fax: (01442) 351010
E-mail: info@cconcepts.co.uk
Web: <http://www.cconcepts.co.uk>
Computer Concepts will be demonstrating and selling their complete range of publishing and multimedia products, including the new StrongARM versions of *Impression*, *ArtWorks*, and *TurboDrivers*, and the latest printers from Canon.

Cumana

Stand 52
Boundary House
The Pines
Broad Street
Guildford
Surrey GU3 3BH
Tel: (01483) 503121
Fax: (014830) 451371
E-mail: sales@cumana.co.uk or support@cumana.co.uk
Cumana will be showing OSCAR, its unrivalled performing Parallel Port CD-ROM drive. Also on show will be the highly successful proTeus combined CD and optical drive as well as other Cumana peripherals such as our fast SCSI 2 32bit Interface card.

Dalriada Data Technology

Stand 114
74 Greville Road

Warwick CV34 5PJ
Tel/fax: (01926) 492459
E-mail: sales@dalriada.demon.co.uk
Web: <http://www.dalriada.demon.co.uk/>
Dalriada will be releasing the latest version of their popular table editor *TableMate*. *TableMate Designer* provides a significant leap forward in the number of facilities *TableMate* offers. Three other releases are on their stand, plus a preview of their World Wide Web software.

Davyn Computer Services

Stand 22
The Workshop, off Princess Street
Wakefield
West Yorks WF4 1PG
Tel: (01924) 210100
Fax: (01924) 258036
E-mail: martyn@davyn.demon.co.uk
Davyn Computers will once again be showing RiscCAD, their 2D CAD package, being shown for the fourth year in succession. Improvements include multi-thickness lines, additional drafting tools and improved plot management. The program author will be on hand to give live demonstrations.

Desktop Projects Ltd

Stand 40
Unit 2A Heapriding Business Park
Ford Street
Stockport
Cheshire SK3 0BT
Tel: 0161-474 0778
Fax: 0161-474 0781
E-mail: sales@desktopp.demon.co.uk
WWW: <http://www.desktopp.demon.co.uk/>
Desktop Projects will be selling Risc PC's, SIMM's, ATAPI/SCSI CD-ROM drives, Removable Drives, Psion pocket computers, Printers, Modems, Multimedia Speakers, CD-ROM titles, and other software. We will also be selling our own *QuickLynk*, *QuickTile* and *TopicArtCD*.

DoggySoft Ltd

Stand 80
Furzefield House
Furzefield Road
Beaconsfield

Bucks, HP9 1PQ
Tel: (01494) 673222
Fax: (01494) 675878
E-mail: info@doggysoft.co.uk
Web: <http://www.doggysoft.co.uk/>
DoggySoft will be demonstrating and selling the latest version of the *Termite* Internet communications suite. We will have special show offers on complete packages including software, modems and Internet subscriptions.

Economats (Education) Ltd

Stand 110
Epic House
Darnall Road
Attercliffe
Sheffield S9 5AA
Tel: 0114-281 3344
Fax: 0114-243 9306
Economats (Education) Ltd will be exhibiting at Acorn World for the first time. With a wealth of experience in Acorn software development and as leading suppliers of technology teaching equipment, we will be demonstrating Acorn computer control solutions. A range of special packages have been developed which include *Logicator* flowsheet control software and *Fischertechnik* modelling solutions along with teaching materials. Special show offer prices will be available.

Eesox

Stand 134
Suite 8C Newton House
147 St Neots Road
Hardwick
Cambs CB3 7QJ
E-mail: eesox@eesox.demon.co.uk
Web: <http://www.eesox.demon.co.uk>
Our full, latest range of CD-ROM drives including SCSI, IDE and parallel port drives. CDWriter systems. CDBrick - the alternative to CD-ROM towers for networking CD-ROMs. The latest *CDFast2* CD-ROM caching software. Graphic Tablets and graphic software applications. Memory, SCSI interfaces, and other peripherals.

Electronic Font Foundry

Stand 18
Granville House
50-52 Upper Village Road
Ascot
Berkshire SL5 7AQ

SIMTEC
ELECTRONICS

... the Quality Upgrade

INTRODUCTORY
OFFER

VRAM solutions for the Risc-PC....

Using our expertise in expandable module design and our development of the smallest SOJ sockets available, we have been able to manufacture the first user-expandable 1Mb Risc-PC VRAM module. Unlike existing VRAM designs, our 1Mb card has empty sockets on the reverse side and can be easily user-expanded to 2Mb in a few minutes by plugging in the extra chips. There is no need to suffer the risk and inconvenience of sending this card away to be upgraded. All our cards and upgrades are guaranteed to be 100% new product.

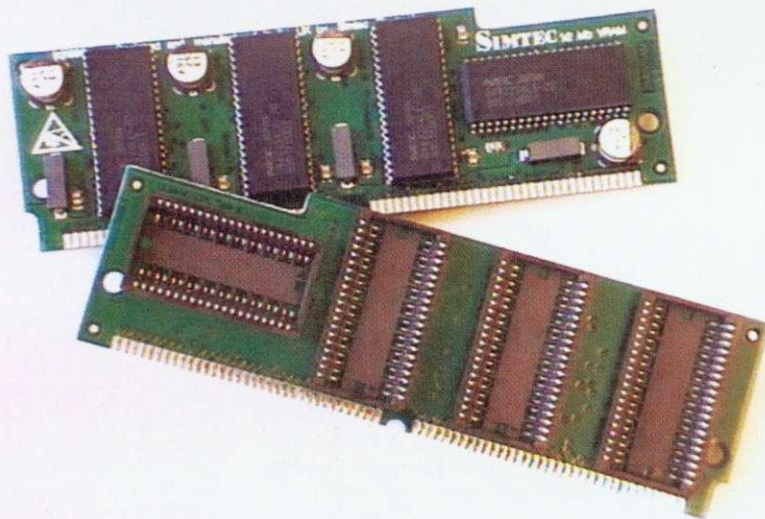

2Mb VRAM - £115 1Mb user-expandable VRAM - £80

1-2Mb plug-in chip upgrade - £59

To mark the introduction of our new card, we are offering **2Mb cards for only £95** when you trade-in your existing 1Mb Acorn VRAM card

Whatever your machine, if you need more memory choose Simtec, the quality upgrade. A full range always in stock.

Every upgrade is fully tested before despatch and carries our usual two-year warranty.

Prices include UK carriage and VAT @ 17½%

SIMTEC
ELECTRONICS



Tel: (01344) 891355
 Fax: (01344) 872923
 E-mail: info@efffonts.demon.co.uk
 We shall display and sell new and well established fonts in many languages including all European, Cyrilli, Greek, Hebrew, Indic etc. Our expertise in typography and font design is second to none and we are able to design or trace already designed fonts from any source.

ESP

Stand 46
 21 Beech Lane
 West Hallam
 Derbyshire, DE7 6GP
 Tel/fax: 0115-929 5019
 E-mail: sales@ExSoftPr.demon.co.uk
<http://www.cybervillage.co.uk/acorn/esp/>
 Software Synthesiser with improved instruments and facilities. Extra instruments for the Synthesiser. Synthesiser instrument editor. Parallel Port MIDI Interface. News of developments that provide new MIDI and sound facilities with particular use of StrongARM. PC Card Sound and MIDI updates.

Fabis Computing

Stand 132
 48 Charles Street
 Church Gresley
 Swadlincote
 Derbyshire DE11 9QD
 Tel: (01283) 552761
 Fax: (01283) 552761
 E-mail: info@fabis.demon.co.uk
 Web: <http://www.fabis.demon.co.uk>
 EasyFont Professional will be released at the show with many new features. RRP £59.95 Upgrade for EasyFont3 users £15 and please bring along your original disc.

Icon Technology Ltd

Stand 64
 5 Jarrom Street
 Leicester LE2 7DH
 Tel: 0116-254 6225
 Fax: 0116-247 0706
 E-mail: icon@lccapple.demon.co.uk
 Import and export of word documents are among the new features in the versions of EasiWriter and TechWriter to be released at the Acorn World show. Other improvements include automatic

numbering, RTF import and export. Special show offers are available.

Insight Training

Stand 201
 PO Box 864
 Cambridge CB5 9RX
 Tel/fax: (01223) 812927
 E-mail: insight@argonet.co.uk
 Web: <http://www.argonet.co.uk/business/insight/>
 Insight Training offers a growing range of Acorn-based courses. Visit the stand to check out the show offers, buy your own training manuals, pick up your own 1997 training schedule and discuss your IT training needs with Insight.

Iota Software Ltd

Stand 38
 Iota House
 Wellington Court
 Cambridge CB1 1HZ
 Tel: (01223) 566789
 Fax: (01223) 566788
 E-mail: sales@iota.co.uk
 Web: <http://www.iota.co.uk>
 Some great offers are available on the Iota stand this year, make sure you don't miss out! From excellent animation software to typing tutors and powerfully easy to use databases, there is something on offer for everyone!

Irlam Instruments Ltd

Stand 98
 Brunel Institute for
 Bioengineering
 Brunel University
 Uxbridge
 Middlesex UB8 3PH
 Tel/fax: (01895) 811401
 Desktop video systems for TV display, digitising, Replay capture and high-quality video editing will be demonstrated including RiscTV, 24i16 and Videodesk. A complete range of colour scanners will be available from low-cost motorised units to A4 flat-beds. Special offers will be available on selected products.

Kimberley Computers Ltd

Stand 76
 73 Chapel Street, Leigh
 Lancashire WN7 2DA
 Tel: (01942) 677777
 Fax: (01942) 672300

E-mail: info@kimberley.com
 or sales@kimberley.com

Web: <http://www.kimberley.com>
 Kimberley Computers will demonstrate Arcshare the Acorn to PC networking program. All the usual items for sale such as Hard Drives, Memory upgrades, printers and consumables at competitive prices. We will also be demonstrating the Casio and Kodak range of digital cameras.

MCS

Stand 370
 Baroper Bahnhofstr. 55
 44225 Dortmund
 Germany
 Tel: + 231 759283
 Fax: + 231 750455
 E-mail: mcmike@knipp.de
 Web: <http://www.acebacc.de>
 Connect 32 Fast SCSI card, VRAM upgrades, PC card upgrades from SXL-40 to 586/133. We can exchange cards at the show and update your VRAM from 1Mb to 2Mb as well. We will also have hard discs, CD-ROMs, PS/2 modules.

Oregon Developments

Stand 34
 36 Grosvenor Avenue
 Streetly
 Sutton Coldfield, B74 3PE
 Tel: 0121-353 6044
 Fax: 0121-353 6472
 There's lots to see on Oregon's stand this year. See *Prosound*, a fully integrated eight channel hard disc recording, sound editing and audio processing suite. There will also be the Oregon SPDI interface and *Cineworks*, now StrongARM compliant and with several improvements as well as demos of early versions of *MIDIWorks* throughout the show.

Pineapple Software

Stand 118
 Suite 13/14 South Park
 Business Centre
 310 Green Lane
 Ilford
 Essex IG1 1XT
 Tel: 0181-599 1476
 Fax: 0181-598 2343
sales@pineapple.demon.co.uk
 Pineapple will have all its usual products on show with a special feature on colour scanning. Walter Briggs will be demonstrating *Studio24 Pro* and there will be a special release of

Studio24 version 1 at just £29.00.

Q-Tec Technological Resources

Stand 370
 Unit 22 Brougham
 Enterprise Centre
 Brougham Terrace
 Hartlepool TS24 8EY
 Tel: (01429) 890800
 Fax: (01429) 890700
 Computer music products: new MIDI interfaces (inc. A4), controller keyboards, modules, active speakers, software. Connect 32 SCSI2 Cards: SCSI devices, All cables standard and customised. Acorn Risc PC systems, StrongARM SCSI 2 systems. Official StrongARM promotional beer glasses!

Quill Marketing

Stand 72
 11 Hemmings Close
 Norwich NR5 9EH
 Tel: (01603) 748002
 Fax: (01603) 748003
 Jetprint T-shirt transfer papers as well as a full range of ink jet refills, including pigment based inks will be shown. A stand full of creative ideas. Look at Digital Imaging!

R-Comp

Stand 96
 22 Robert Moffat
 High Legh
 Knutsford
 Cheshire WA16 6PS
 Tel: (01925) 755043
 Fax: (01925) 757377
 E-mail: htmledit@arsvcs.demon.co.uk
 Web: <http://www.arsvcs.demon.co.uk/r-comp/>
 HTMLEdit2, the acclaimed Web authoring package, will be supported by a stand-alone utilities pack essential for all designers. Try the new ACECAT2 graphics tablet with Acorn drivers. Add life to your PC card with an unparalleled level of SoundBlaster emulation.

RE at Lampeter University

(See Wyddfa Software)

Resource

Stand 78
 51 High St
 Kegworth
 Derby DE74 2DA
 Tel: (01509) 672222

Fax: (01509) 672267
 E-mail: info@resourcekt.co.uk
 Award-winning, all-talking, all-animated *Talkwrite*. Mini-books with maximum impact form *Bookmaker*. New nursery rhymes and stories in *Rainbows Edge* - new CDs at the cutting edge of entertaining education. Brilliant graphics, quirky animations and some great story readers!

SEMERC

Stand 120
 1 Broadbent Road
 Watersheddings
 Oldham OL1 4LB
 Tel: 0161-627 4469
 Fax: 0161-627 2381
 E-mail: info@semerc.demon.co.uk
 Educational software for early years, primary and secondary including a range of software and access devices for pupils with special needs. Available for Acorn, PC Windows and Apple Macintosh machines. Pick up a catalogue from the SEMERC stand.

Serious Statistical Software

Stand 32
 Lynwood
 Benty Heath Lane
 Willaston
 South Wirral L64 1SD
 Tel: 0151-327 4268
 E-mail: sss@argonet.co.uk
 Web: <http://users.ox.ac.uk/~jo95006/first>
 We shall demonstrate our user-friendly statistical packages *1stL*, *1stJr* and *1st*, priced between £50 and £205 (no VAT), with their excellent graphics and data handling. Widely used in schools and further education they are now handling administrative tasks too.

Sherston Software Limited

Stand 86
 Angel House
 Sherston
 Malmesbury
 Wiltshire SN16 0LH
 Tel: (01666) 840433
 Fax: (01666) 840048
 E-mail: info@sherston.co.uk
 Web: <http://www.sherston.com>
 Sherston Software will be launching an exciting development at Acorn World '96. *Rusty Dreamer* is the ultimate reading experience



Acorn World '96 Show Guide

from new Sherston author Mike Matson, this CD-ROM adventure is an ambitious project by any standards. Using a brand new video animation technique developed by Mike, *Rusty Dreamer* brings a new dimension to educational multimedia.

Sibelius Software

Stand 42
75 Burleigh Street
Cambridge CB1 1DJ
Tel: (01223) 302765
Fax: (01223) 351947
E-mail: info@sibelius.demon.co.uk
Web: <http://www.acorn.co.uk/developers/sibelius/>
Sibelius 7 (full professional version); *Sibelius 7 Student* (Semi-professional and A-Level standard); *Sibelius 6* (GCSE standard); *Junior Sibelius* (for absolute beginners). Music software for composing, playing, arranging, recording, teaching and printing music.

Simtec Electronics

Stand 66
Avondale Drive
Tarleton
Lancs PR4 6AX
Tel: (01772) 812863
Fax: (01772) 816426
E-mail: info@simtec.demon.co.uk
Simtec will be showing their developments which range from new user-expandable VRAM upgrades to multi-processing and multi-threading under RISC OS. They will also be showing their extensive range of memory upgrades.

Smart DTP

Stand 126
36 Park Road
Duffield
Belper
Derbyshire DE56 4GR
Tel: (01332) 842803
Fax: (01332) 842803
E-mail: jamesparry@smart-dtp.telme.com
We will be launching Release 3 of *PublishArt* at the show at a very special show price.

We don't want to say too much here, but we'd love to show you the new package in person. Existing *PublishArt* users will be able to upgrade on the day.

Softease Limited

Stand 378
The Old Courthouse
St Peters Church Yard
Derby
DE1 1NN
Tel: (01332) 204911
Fax: (01684) 772922
E-mail: sales@softease.demon.co.uk
Softease are launching *Multimedia TextEase*. This allows you to add video, animation and sound to your *TextEase* documents. Whether for fun, for learning or for communication, it will bring your documents to life. Move your communications into the next century with the help of *Multimedia TextEase*.

Spacetech Ltd

Stand 88
21 West Woods
Portland
Dorset DT5 2GA
Tel: (01305) 822753
Fax: (01305) 860483
E-mail: sales@spacetec.demon.co.uk
Web: <http://www.digibase.com/spacetech>
Spacetech will have an announcement at the show about additions to the *Photodesk* range of products. Also it is expected that they will be previewing the new 'Gemini' version of *TopModel* from Sincronia Multimediali of Italy with Paolo Rossi in attendance.

System Insight

Stand 44
Hillcrest House
Shirrel Heath
Southampton SO32 2JS
Tel: (01329) 835500
Fax: (01329) 835501
System Insight will be exhibiting a complete range of inkjet printer consumables, including original cartridges, the renowned range of inkjet cartridge refill systems, a full range of transparency films, 720 and 360 dpi papers and a high quality, low cost gloss paper.

TBA Software

Stand 138
Mead Farm
North Road
Tisbury
Bath
Somerset BA3 1JU
Tel: (01761) 470003
As well as all the usual games

and joypads. TBA this year will be selling a new 2-in-1 game pack containing *Mirror Image*, a new TAG strategy game, and *Merp*, a fun multi-player game. Also on show will be *TBAFS*, a very fast file archive compression system for RISC OS, you'll never need another compression system again! The first public TAG 2, the next generation of RISC OS 3D engine, demos will be running on StrongARM processors at the stand. There will also be special show offers for game bundles.

The ARM Club

Stand 386
Woodleigh Lodge
32 Stoughton Lane
Stoughton
Leicestershire LE2 2FH
Tel: 0171-624 9918
Fax: 0181-446 3023
E-mail: treasurer@armclub.org.uk
Web: <http://www.armclub.org.uk/>
The ARM Club will be fronting the club area at the top of the stairs, stand 386. For the first time, a number of local clubs will be represented including the Bottisham Acorn User Group and a number of others. Membership of and information about The ARM Club will be available and club members and non-members will have the opportunity to discuss technical problems and seek advice about Acorn related products. We will also have our range of software products, including a package to solve some incompatibility problems with StrongARM cards and possibly a new PD CD, following on from the success of the first which was launched at last year's show.

The Datafile

Stand 17
Willoughby House
89 Woodville Road
Boston
Lincs PE21 8BB
Tel/fax: (01205) 354203
E-mail: Sales@datafile.co.uk
Release of PDCD-4 which will contain the full version of *Merlin* with the option of a StrongARM upgrade for £30. The new *Copperplate* fonts package designed by Tony Nash plus our other fonts packages and CDs.

The Guardian Newspaper

Stand 112
119 Farringdon Road
London EC1R 3ER
Tel: 0171-278 2332
Fax: 0171-278 1449
The Guardian Newspapers Limited welcomes visitors and other exhibitors to view a number of products in its portfolio. On display will be *The Guardian Education and Online*, *The Guardian's* weekly computer section. There will also be a great opportunity to enter a competition to win £3000 worth of prizes from Xemplar. Visitors to the stand are invited to take a complimentary copy of the days newspaper.

Uniqueway

Stand 56
3 Clarendon Road
Cyncoed
Cardiff CF3 7JD
Tel: (01222) 464020
Fax: (01222) 440071
E-mail: sales@uniqueway.co.uk
Web: <http://www.uniqueway.co.uk>
Uniqueway will be showing the latest volume three of the *Risc Disc CD*, plus *Riscrypt-Pro*, the professional version of the PD Postscript viewer. There will also be the usual show offers on hardware and software.

Warm Silence Software

Stand 36
St Catherines College
Oxford OX1 3UJ
Tel: (0585) 487642
E-mail: Robin.Watts@wss.co.uk
Web: <http://www.wss.co.uk>
Warm Silence Software will be showing new versions of all its products including *MovieFS*, *VRView*, *Larger*, *6502EM*, *Z80EM* and tapes and will be previewing forthcoming releases including new Floating Point Accelerator software.

Wyddfa Software

Stand 376
3 Preswylfa
Llanberis
Gwynedd LL55 4LF
Tel: (01286) 870101
Fax: (01286) 871722
Wyddfa Software, Caiti Software and The Lampeter University Education Project

are demonstrating their new religious education software. Also on show are KS1 English and Maths programs that are particularly suitable for children with special needs. Bargain show prices.

Xemplar

Stand 84
The Quorum
Barnwell Road
Cambridge CB5 8RE
Tel: (01223) 724724
Fax: (01223) 724324
Web: <http://www.xemplar.co.uk>
Xemplar will be demonstrating a selection of the best in educational solutions running on Acorn computer platforms. Visit our stand to find out why schools come to us for the most appropriate and creative learning solutions. For Secondary, we will be showcasing our Maths, English, Science, Geography and Design and Technology Toolboxes. For Primary, we will feature the Xemplar Junior Toolbox for RISC OS, the Reading Development Resource Pack and Curriculum Resource Packs. We will also be demonstrating Pocket Lab, Pocket Control, the Internet and Special Needs solution.

YITM

Stand 104
Television Centre
Leeds LS3 1JS
Tel: 0113-243 8283
Fax: 0113-243 4884
E-mail: yitminfo@yitm.co.uk
YITM, the leading publisher of educational CD-ROMs announces the launch of an exciting new disc - *Science Explorer*, which allows the user to experience the wonders of a virtual science exploratory. Visit stand 104 for your demonstration.

Zenta

Stand 130
10 Ravenhurst Drive
Birmingham
B43 7RS
Tel: 0121-358 3054
Fax: 0121-358 5969
E-mail: Sales@zenta.demon.co.uk
Web: WWW.ZENTA.demon.co.uk
Zenta will be extending our range of essential lowcost CD-ROMS, and making some special offers on the existing range. They will also be an opportunity for non-CD customers to purchase special low price fonts on floppy discs.

Productive Finance software

Personal Accounts v3

Running your personal finances on a computer might seem like overkill, but until you try you will never know the benefits.

Keeping track of direct debits and standing orders is at best fiddly and at worst expensive when you consider the charges most banks levy if you become overdrawn.

Personal Accounts takes the

guesswork out of it. You will know exactly how much you have in each account and when it needs topping up. This, however, is only one of Personal Accounts' many features.

"Far **faster and easier** than any other package... **an absolute dream** to use..." – Acorn User.

"**You'll wonder how you ever coped.**" – Archimedes World.



Prophet (Business Accounts) v2

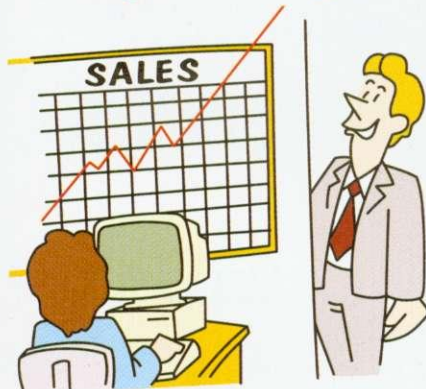

If a computer program could replace a manual business system and not only give you more information but also save you time, it would be a worthwhile investment.

If it could automatically enter standing orders on time, send overdue statements to your customers, produce VAT returns (approved by UK Customs and Excise), calculate Profit or Loss and

balance sheets *and* cost less than £200, it would be an absolute bargain.

Prophet not only does *all* this but offers features too. In fact it has features not available in any other computer accounting package.

It is therefore no wonder it was awarded **Best Business Software** by Acorn User in 1995.

Shares v5

Dealing in stocks and shares can be a time-consuming activity, but you can speed things up...

Shares 5 produces detailed summaries including capital gains tax and growth functions for

comparing different financial products.

Comprehensive graphing facilities include moving averages, historical low and interest rate comparisons.

"**Apricote has a talent for providing well-presented and simple software that has considerable technical sophistication lurking behind the user interface**" – Acorn User.

APRICOTE Studios

2 Purils Bridge Farm • Manea • Cambs • PE15 0ND

01354 680432



Acorn User Subscription Offer*

To celebrate the return of the Acorn World Show, Acorn User has teamed up with show organisers and 12 leading Acorn specialists to offer all new subscribers one hell of a deal.

All offers are exclusive to all new Acorn User subscribers or renewals, and are in addition to any offers already advertised by these companies at the show.

Subscribe... Save money, get a free ticket to **Acorn World**, fabulous money saving vouchers and 13 issues of the World's leading Acorn mag delivered free to your door! All for only £39.99

As well as receiving a free adult ticket to the show, worth £5, subscribers will get 12 vouchers saving you big money off some of the best software and hardware peripherals around. In fact you can save in excess of £170 off a host of products from:

Sibelius Software • Anglia Multimedia
VTI Eclipse • JetPrint
AVP • Warm Silence Software
Desktop Projects • Doggysoft
Colton Software • Oregon Developments
CJE Micros • Softease Ltd

And after you've taken in the show, Acorn User will keep you up to date on all the latest developments in the world of Acorn computing over the next 13 issues. After all, we've been the main source of information for all Acorn enthusiasts for the past 13 years.

* UK only

ACORN USER

Your ticket to the best offers around



ACORN WORLD '96 SUBSCRIPTION OFFER

Sibelius Software

Free set of headphones for every subscriber



25% discount on software



Extra months internet access free



Over 20% off T-shirt printing (Jet Print)



25% off rrp price of all show stock (A.V.P.)



30% off MovieFS software package (Warm Silence S/W)

Desktop Projects Ltd

£5 off any DP software titles



15% discount on any internet show package (Doggysoft)

COLTON software

50% off Fireworkz for RISC OS

oregan

3 software titles for £19.95

CEmicro's

Over 28% off a pair of 25 watt multi media speakers



25% off rrp of Multimedia Textease and Talking TextEase

Yes! I will subscribe...

1a Take advantage of one of these offers TODAY before we change our minds! See section 2

4237 UK £39.99

To renew subscription please tick:

4238 UK £39.99

*Unfortunately World subscribers are not eligible to receive the free gift/special offer

I wish to pay by: Cheque/postal order made payable to IDG Media
 Credit card (Visa/Access/Barclaycard/Mastercard/Eurocard/Connect)

Expiry date /

Card No.

1b Please enrol me as a subscriber to *Acorn User*.

4210 with payments of £9.49 by continuous quarterly direct debit See section 2.

Your subscription will continue until you cancel. Over a year you will receive 13 issues.

Name of Bank/Building Society

Address

Name of Account

Your Account No.Sort Code

DateSignature(s)

Your instructions to the bank/building society: Originator's ID No. 851412

I instruct you to pay direct debits from my account at the request of IDG Media. The amounts are variable and may be debited on various dates. No acknowledgement required. I understand that IDG Media may change the amounts and dates only after giving me prior notice. I will inform the bank/building society in writing if I wish to cancel this instruction. I understand that if any direct debit is paid which breaks the terms of the instruction, the bank/building society will make a refund. Bank/building society may decline to accept instructions to pay direct debit from some types of accounts.

3 Name (Mr/Mrs/Ms/Miss)

Address

PostcodeTel

4 Now send your completed form and payment to Acorn User, Database Direct, FREEPOST, South Wirral L65 3EB. Tel: 0151-357 1275. Please state if credit card billing address is different from the delivery address. Photocopies or handwritten versions of the above information are acceptable.

133MHz 5x86 PC Cards

Processor/Speed :	Stand Alone (RRP) :	Part Exchange SX/33 :	With New Computer :
CJE 5x86 133MHz*	460.00	350	350
Acorn 5x86 100MHz	468.83	350	350
Acorn 486 DX4/100MHz	349.83	234	234
Acorn 486 DX2/66MHz	292.58	175	175
Acorn 486 SX/33MHz	233.83	-	117

5x86 133MHz cards are Acorn Mk II Gemini Cards upgraded by us.

*Up to 933% faster than a standard SX/33 and 26% faster than Acorn's 100MHz 5x86.

If you can buy cheaper, tell us...

...If you can't, tell your friends!!

IDE CD Rom Systems Quad Speed £ 60 SIX Speed £ 80 EIGHT Speed £ 90

(Above Pricing is for RISC OS 3.6 or 3.7. For 3.5 add £ 15).

SCSI CD Rom Drive Double Speed - tray loading £ 95

SCSI CD Rom Drive 6.7 Speed - tray loading £ 170

SCSI CD Rom Drive EIGHT Speed - tray loading £ 200

Combined Quad Speed SCSI CD Rom Drive AND 650MB Optical Read/Write Drive £ 375*

Complete CD Rom Systems for A3/4/5000 £ 259

SCSI I Interface for A30x0/A4000 £ 115

SCSI I Interface for A300/A400/A5000/Risc PC from £ 90

SCSI II Interface (Cumana / PowerTec) £ 195

All CD ROM Drive examples are for internal RiscPC versions. For details of other versions please call.
Cases for External CD Rom Drives from £ 47 Caddies from £ 5 *Optical Discs for PD Drive £ 46

All prices
Include VAT
@ 17.5%

0%

RiscPC's from £ 52 p.m.
20% deposit.
20 Months to pay.
Call for further details.



RiscPC Ram

4MB	£ 25	1MB V-RAM	£ 100
8MB	£ 50	2MB V-RAM	£ 150
16MB	£ 91	1-2MB V-RAM	£ 100
32MB	£ 186	For DRAM Part Exchange prices please Call.	

Monitors

14" Microvitec SVGA (AKF 60 equiv.)	£ 225
14" Microvitec MultiSync (AKF 50 equiv.)	£ 300
15" Link LN-15E (0.28mm FST MPC 1280 x 1024)	£ 300
17" Idek 8617e (0.26mm FST MPC 1600 x 1200)	£ 620
17" Idek 9017e Pro (0.25mm FST MPC 1600 x 1200)	£ 675

Hard Disc Drives

210MB Conner 3.5" IDE	£ 90
425MB Conner 3.5" IDE	£ 125
540MB Conner 3.5" IDE	£ 135
1.2GB Quantum Fireball 3.5" IDE	£ 195
1.6GB Conner 3.5" IDE	£ 220
2.5GB Fujitsu 3.5" IDE NEW	£ 290
540MB IBM 3.5" SCSI	£ 165
1.0GB IBM 3.5" SCSI	£ 250
2.0GB IBM 3.5" SCSI	£ 395
Hard Disc Kits for A3000 from (A3020 from £ 90)	£ 175
Syquest EZ135MB 3.5" Drive from	£ 115
Xyratex 540MB Drive (removable cartridge) NEW	£ 320
Iomega 1GB JAZ Drive (removable cartridge) NEW	£ 460

Printers

BJ30 Black	£ 170	BJC610 Colour	£ 360
BJC210 Colour	£ 190	Stylus Colour 500	£ 300
BJC4100 Colour	£ 250	HP5L 4ppm	£ 430

Risc PC's

15" Monitors at 14" Prices

with ACB75 RiscPC systems.

(£ 15 ACB77 / £ 25 ACB64)

OR

£ 5 Quad Speed CD Drive

with ACB 75 RiscPC systems.

(£ 15 ACB77 / £ 25 ACB64)

Prices above are for Quad Speed.

£ 20 Extra for SIX Speed. £ 30 Extra for EIGHT Speed.

Complete RiscPC Systems from £ 1299.

RiscPC's Built to your specification.

Example : RiscPC 200MHz StrongARM, RISC OS 3.7,
1.6GB H/D, 16MB RAM, 2MB V-RAM, 15" FST Monitor

£ 1800 inc. VAT & Delivery.

We have a few **NEW** Mk1 RiscPC phone for details.
StrongARM & RISC OS 3.7 can be added to these for only £ 116.33

All Prices **Include** VAT @ 17.5%

Post from £ 2.50 Courier from £8.00

Credit Cards & Official Orders Welcome.



78 Brighton Road, Worthing, West Sussex, BN11 2EN Telephone : 01903 523666 Fax : 01903 523679

Email : ciemicro@navilion.co.uk Web : <http://www.art.acorn.co.uk/soft/CIE/>

960919/GT

StrongARM is here!

As you read this the first batch of StrongARM cards for the Risc PC will be winging their way across the country to Acorn Clan members. I spoke to Chris Cox and Dave Walker just two weeks before they expected the first ones to ship.

As the StrongARM processor prototypes are evaluated they continue to delight and surprise both Acorn and third party developers alike. When you use an application regularly you get to know how it reacts and expect delays when doing certain actions. It's when those expectations are not realised you get a surprise and a buzz.

For example one person at Acorn uses ProCAD for all the building work, floor plans and so on, it normally took about 20 seconds to download from the network and rendered on screen. So one day the development team slipped a StrongARM card in his machine without him know-

Mike Cook reveals the facts behind the power of the StrongARM chip

ing. The following morning, when he came to use it, the whole job was completed in less than a second, he was speechless. When he recovered he spent a good part of the day showing others how fast it was — a case of a faster processor not increasing productivity.

I suppose you could have predicted some sort of speed increase for that but no one expected formatting a floppy disc to be affected, in fact it's 15 to 20 per cent faster. Network access and Internet operations also show a speed increase.

So the big questions are, what makes the StrongARM so fast and just how fast is it? As you might expect there are many interdependent factors in play here, so many, in fact, that the full impact could not be evaluated before the prototypes arrived.

Perhaps the easiest to understand, initially at least, is the clock speed, at a nominal 200 MHz it is about three times faster than the fastest previous ARM chip. The exact clock speed is generated inside the chip and is expected to be 202.4 MHz.

Now that does not always produce a three times increase in overall speed because the computers main memory can't be accessed that fast, the chip has to slow down to do that. One way round this is to have a small section of memory on the processor chip itself.

Any instructions fetched from the main memory are stored there so that if they are needed again the processor doesn't have to slow down to get them. This is known as Level 1 cache as it is actually inside the processor chip.

A Level 2 cache is fast memory that is added to the processor card, — it is not main memory but a buffer between the main memory and the processor. It would be too costly to have faster chips for all the machine's memory but a few K can improve things.

The current StrongARM card does not have a Level 2 cache and it's looking like speed improvements from it would only be marginal. However, Acorn are committed to producing at least an evaluation prototype of this type of card.

Now those of you that know the old ARM3 and ARM6 chips will know

The size of a 586 Pentium-type processor to the StrongARM — brute force versus elegance

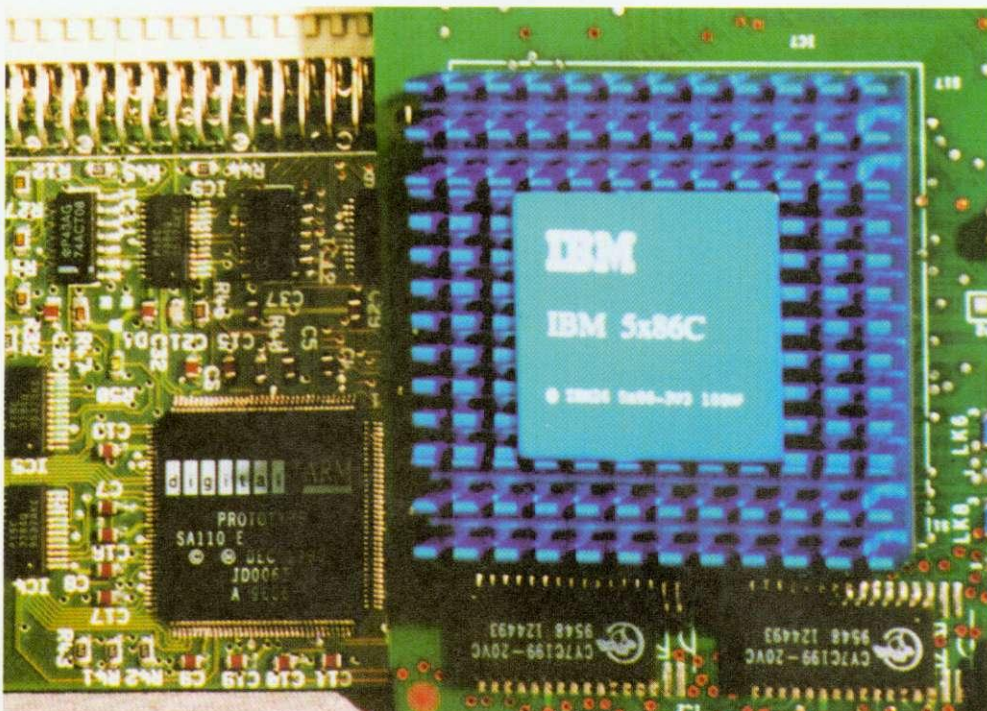

You can buy the next issue of **Parents & Computers** for only **£1**

r.r.p. £2.25

Parents & Computers
A guide to **education** for 3-11 year olds

Reading standards
how computers can teach children to read and write

Families and the Internet
the options, the costs and the pitfalls

Daley Thompson on the small screen

Getting the school you want
when to start choosing the secondary school

Which computer?
we look at palmtops, desktops and fun solutions

Essential for all parents with or about to buy a PC, Mac or Acorn

Autumn 1996 £2.25

Parents & Computers **£1 Offer**

Please send me the next issue of Parents & Computers. I enclose £1 (coin or cheque/postal order made payable to IDG Media)

Name

Address

.....

Tel



Affix coin here



I don't wish to receive any additional promotional materials.

Send to: Parents & Computers, £1 Offer, Media House, Adlington Park, Macclesfield SK10 4NP.

A guide to **education** for 3-11 year

Parents & Computers is essential reading for anyone with children concerned about how computers are used in school, standards of education and how you, the parent, can make a real difference.

All you have to do is send off the coupon to the address below and we will send you the next issue of this outstanding magazine for just £1.



The original StrongARM board

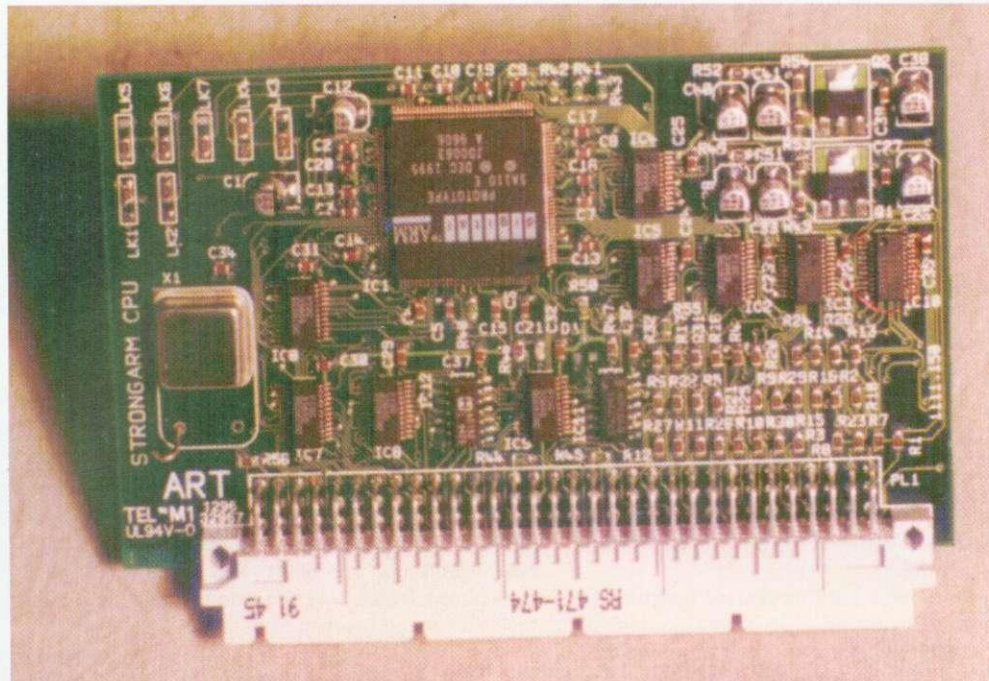

that they have Level 1 caches, so why does this bring about a speed improvement in the StrongARM? There are basically two reasons. First of all it's much bigger at 16K and secondly the processor architecture has been changed completely to a Harvard architecture. This means that there are two Level 1 caches inside the processor, one for the data and the other for instructions, each 16K. This arrangement is much more efficient at running programs, requiring much less access to the comparatively slow main memory and making the most of the fast clock speed.

Another speed boost comes from a new unified 5 stage pipeline structure, (see panel for details). This makes the act of executing a series of instructions much more efficient by, in effect, doing some

operations in parallel. The ALU or Arithmetic Logic Unit has also been redesigned, and as a result some operations are faster.

It's the multiply instruction that benefits most taking just 1 to 3 cycles compared to 3 to 16 cycles before — these cycles are three times faster due to the clock speed. Perhaps the most exciting consequence to the ordinary programmer is that BASIC programs show the greatest speed up of all, from 10 to a staggering 20

The most exciting consequence is that BASIC programs show the greatest speed increase of all

times faster. This from a processor that on paper is only about five times as fast. Are you listening, Bill? At least 1000% faster!

The reason for this is quite interesting and owes its origin to the early BBC Micro. The BASIC interpreter in the early machine had to fit into the memory of an 8-bit processor and so was very compact, about 16K. As this was adapted for the ARM chips, the increased width of the data bus meant it was *simpler* to write an interpreter.

So extra features were added and the size of the interpreter stayed at about the same size. Now it just so happens that the whole of the Basic interpreter fits into the cache of the StrongARM chip making the world's fastest BASIC interpreter, even faster! The greatest speed increases show up in program that perform large amounts of calculations, like satellite tracking or coordinate transforms used in 3D graphics.

Compiled C programs do not show as much improvement, typically 5 to 10 times. There has been some concern about the C compiler not working but release 5 does work, in fact they used it to create the new operating system.

Programs written in hand-tuned assembler can also show a huge speed increase. The record goes to a piece of code that didn't do anything useful but was specially written to highlight the new processor. That one clocked in with a 35 times speed increase, which is a

Pipeline structure

When a processor executes an instruction it goes through a number of stages. First it has to be fetched from memory, then decoded, that is, the correct arithmetic and logic elements must be activated. Depending on what the instruction does, various internal registers have to be loaded with numbers. Finally the results of the operation have to be placed somewhere.

Originally, in microprocessors, one instruction went through each stage before the next instruction cycle was started. Pipelining is the technique whereby when an instruction finishes one stage, that stage starts working on the next instruction so the overall throughput of instructions is faster. However, it does not always work so smoothly, for exam-

ple, take the case of a branch. When the processor decides that a branch in the code should be taken, the instructions already in the pipeline are useless and need to be thrown away.

Therefore for a program to execute best in a pipeline branches should be avoided, but for a program to work best with a small cache you should have lots of tight loops, there's always a tradeoff. However, in general the more stages you have in your pipeline, the more efficiently you can execute your instructions.

The ARM processor has conditional operation on all of its instructions, this tends to reduce the need for short branches in code. Hence this sort of code benefits more from pipelineing.

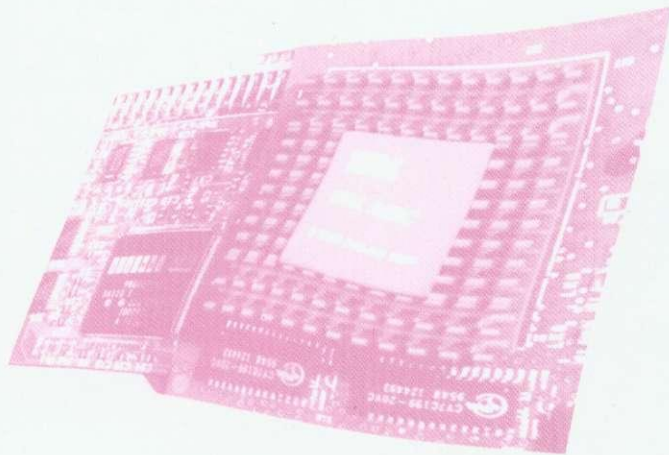

good example of how to manipulate benchmarks.

One universally recognised benchmark is the Dhrystone, it is normally used to compare the raw processing power of different processors. In a recent test a 200MHz Pentium weighed in at an impressive 295K Dhrystones but as you might have guessed the StrongARM outperforms this with 355K Dhrystones.

The StrongARM was always going to have it's downside in terms of compatibility with existing software, but even that is looking a lot better than might have been feared. You see, while the processors instruction set is the same as the older chips there are subtle differences imposed by the change in architecture.

The first big restriction is that you can't write self-modifying code due to the data space and instruction space being separate in the Harvard architecture. An example of self-modifying code might be found in a graphics routine to draw a straight line. When you decided what way the line was going one trick was to store a bit pattern in the appropriate part of the program that would change an instruction from an increment to a decrement. In that way the

program would either be much shorter or much quicker as you don't need to constantly test which way the line is going each time round the loop.

The StrongARM was always going to have it's downside in terms of compatibility with existing software, but even that is looking a lot better than might have been feared. You see, while the processors instruction set is the same as the older chips there are subtle differences imposed by the change in architecture.

Another favourite use for self-modifying code is in program protection where most of the instructions are stored on the disc in an encoded form and the program goes

Installation

Installation of the StrongARM card is not quite as straightforward as just plugging in the card because the operating system ROMs need to be changed as well. This might prevent the more squeamish or ham-fisted from proceeding. Acorn are supplying an anti-static wrist strap just to be on the safe side.

The recommended procedure is to de-install any copy-protected applications back onto their original discs and make a copy of your boot files. Then the operating system ROMs should be changed and the new operating system installed. Only then with the

new system running should the processor card be changed for the StrongARM.

Then reinstall your applications one at a time so you can spot any that cause trouble. Full and detailed instructions are supplied. Incidentally in addition to the floppy discs the new system is also supplied on CD-ROM. This contains lots of extras, like showoff demos, replay movies and the original Risc PC set of slide show images. For those of you who have been hanging onto them this will allow you to free up a bit more disc space.

Pipeline problems

The 5 stage pipeline can also potentially cause a problem. When you store the program counter in memory you actually get the value plus 12 on the old processors, but on the StrongARM you get the value plus 8. Fortunately, when the destination is another register you get the same as the original processor.

One instruction that does cause problems is when you have the PC as the destination and one argument is a shift or rotate specified in a register. This requires the shift to be done in the preceding instruction. Multiple register load and store instructions are also treated differently, they are simply unrolled by the processor into a sequence of single load and store operations, thus taking slightly longer than the old processor.

through the instruction putting them right before they are run. These tricks simply don't work with Harvard architecture.

However, a trick that will work, and is used in many applications, is a jump look-up table. That's where the program stores a byte in memory and later takes that as a jump address, it's a sort of computed GOTO routine. Most developers were initially worried that their programs would need a substantial rewrite but in most cases this proved not to be the case.

There is a growing, definitive list of the software that has been tested on the StrongARM compatibility page at <http://www.art.acorn.co.uk/HOTSTUFF/sacompat.html> However, Acorn found that the kernel, the heart of the operating system, needed rewriting and so they used the opportunity to add in some extras to give us RISC OS 3.7, see the panel for details. Note that this operating system will still work with the older ARM processors and will be available as a general upgrade later.

Another downside to the StrongARM chip is that the whole board only consumes 1 watt of power, so unlike Pentium users you will have to find other ways of making your toast and coffee.

Where to next? Acorn plan to make a big show at this year's Acorn World, they simply want people to use it because it will sell itself. As a follow-up to the show Acorn have a road show that they will take round to major cities in this country, there are even plans to exhibit it at a large German computer show.

In the computer industry there are always exciting new capabilities round the corner but it is a very exciting time as you near the next corner. Acorn's machines are, once again, about to take their rightful place at the front with the fastest processor in town.

Pssst...

Want a hot tip for Acorn World?
Acorn Centre of Technology, Alsystems, has done a deal with ART and secured a large quantity of those fast new **StrongARM** things. Buy one from them at Acorn World for £249 exc VAT and one of their engineers will fit it for you **FREE** while you visit the rest of the show! Call Alsystems now on **01420 561111** to reserve your StrongARM and don't forget to take your RiscPC to **Stand 68** on the day!

HOW GOOD IS YOUR GRAPH DRAWING PACKAGE?



- Does it support OLE for the latest DTP packages?
- Is it simple to mix different graph types?
- Has it got extensive presentation controls?
- Can you put text anywhere you want?
- Are key areas fully under your control?

We could go on for much, much longer, nag about shadow effects, backdrops, automatic table generation etc... Why not contact us for full details of...

GraphMate

Presentation graphics without tears.

GraphMate costs £45 for a Single User pack, p&p included.

TableMate

The Ultimate Table Editor! *Designer*

Coming for Acorn World '96!

- Variable fonts inside cells
- Super- & sub- scripts, bold and italic effects
- Export/import HTML tables for the Internet
- Yet more line and row controls!
- Global cut-and-paste
- Buy TableMate 3 now - upgrade later and save money!

Acorn
World
Stand
114

DiagramIt

Diagrams of all sorts - in a flash!

- Flowcharts, organisational charts, annotated diagrams spider diagrams, process diagrams - and more!
 - Automatic connection of symbols using Artificial Intelligence
 - Full colour control, word wrapping and graphic scaling
- The fastest, easiest and most powerful way to create all those time-consuming structured diagrams - now improved!

Single User - £50. TableMate 3 User - £45.

TableMate 3

"Possibly an essential purchase"
"I would recommend this package to anyone"

- TableMate 2 & 3 Reviews, Archive May 95/Feb. 96

- Buttonbar
- Simple spreadsheet facilities
- Vertical joining of cells, vertical tabs
- Extended import & export ... and much more!

TableMate is simply the most comprehensive tablemaking package available - nothing else comes close.

Single User £34-50; Upgrade from Style/Publisher £19-50



DALRIADA DATA TECHNOLOGY

74 Greville Road, WARWICK, CV34 5PJ.

Phone/Fax: 01926 492459

e-Mail: dalriad.demon.co.uk

WWW: <http://www.dalriad.demon.co.uk/>

Liquid Silicon



Bar Coding Systems
We supply a range of high quality bar code readers from various manufacturers, integrated into the RISC OS 2 or 3 desktop.

Software processing of the bar codes allows input into any multitasking application. Uses include book checking in libraries, product labelling and POS facilities.

We also produce software to create numerous formats of bar codes yourself, enabling all kinds of information to be stored and read back by a reader.



Master Keyboards
Fatar Studio 49 (49 keys) - £122.95
Fatar Studio 610+ (61 keys) - £293.95
Fatar Studio 900 (88 keys) - £593.95
Fatar Studio 1176 (76 keys) - £683.95
Fatar Studio 1100 (88 keys) - £818.95
Fatar Studio 2001 (88 keys) - £1133.95
Roland PC-200 MkII - £185.00

Sound Modules
Akai GM. Piano or Vintage modules - £299.00
Korg X5DR module - £659.00
Roland M-DC1 Dance module - £499.00

Computer Systems

These prices are now valid for all methods of payment.

StrongARM offer for £116.33 to end of December

Risc PC600 4Mb+0Mb 540Mb HD, AKF60 - £1268.53

Risc PC700 4Mb+1Mb 540Mb HD, AKF60 - £1510.28

Risc PC700 8Mb+2Mb 1Gb HD, AKF60 - £1754.03

Monitor options when buying a Risc PC:

Iiyama MF-8515F (15") - add £59.50

Iiyama MF-8617E (17") - add £335.00

Iiyama MF-8617ES (17") - add £350.00

Iiyama MF-9017E Pro (17") - add £449.00

Iiyama MF-8221T (21") - add £1100.00

Iiyama MF-9021T Pro (21") - add £1198.00

Acorn AKF90 (17") - add £369.57

PC cards:

SX-33 - £118.30

DX2-66 - £174.95

DX4-100 - £233.50

5x86-100 - £350.00

5x86-133 - £350.00

PC Exchange - £29.35

IPC Pro (includes PC Exchange) - £47.95

Other options (next column):



FREEPOST EH2725
Kirkcaldy, Fife, KY2 5BR
United Kingdom

Tel: (01592) 592265 Fax: (01592) 596102

email: Liquid@cableinet.co.uk

<http://www.cybervillage.co.uk/acorn/liquid/>

• Computers & Music Hardware • Upgrades • Software • Cables etc •

1Mb VRAM to 2Mb - add £70.00
CD ROM drives - Call
Larger hard drives - Call

Memory Upgrades

Please call to check prices. Others available.
A3010 1-2 Mb - £44.50
A3010 1-4 Mb - £94.00
Risc PC/A7000 SIMMS:
4Mb - £23.50
8Mb - £42.60
16Mb - £84.00
32Mb - £162.00
1Mb VRAM - from £80.00
2Mb VRAM - £145.00
Flash SSD (128k) - £34.95
Flash SSD (256k) - £54.95
Flash SSD (512k) - £89.95
Flash SSD (1Mb) - £119.50
Flash SSD (2Mb) - £192.00
Flash SSD (4Mb) - £325.95
RAM SSD (128k) - £49.95
RAM SSD (512k) - £129.90
RAM SSD (1Mb) - £245.00

Music & Sound Section

This is a small example of our music section
DMI 50 MIDI card - £122.50
Acorn MIDI card - £57.50
MIDI Max card - £79.00
MIDIWorks - Call
Mozart 16-bit sound upgrade - £69.95
Music Studio 32 - £90.95
PowerWAVE 30XG - £265.50
PowerWAVE 50XG - £283.95
Parallel Printer Port MIDI interface - Call
ProSound - £116.95
Rhapsody 3 - £86.95
Serenade - £87.95
Junior Sibelius - £59.95
Sibelius 6 - £179.00
Sibelius 7 Student - £523.00
Sibelius 7 - £925.00
Software Synthesiser - £39.95
Sound Byte Recorder - £44.95
SPDIF interface - Call
Yamaha YST-M5 speakers - £49.00
Yamaha YST-M15 speakers - £66.00
Yamaha YST-M20 DSP speakers - £75.00
YST-MSW10 subwoofer - £116.00

Other Hardware

Connect 32 SCSI 2 Risc PC card - £211.50
2Gb Fast SCSI 2 drives - £435.00
Canon BJ30 - £164.00

Canon BJC70 - £214.00
Canon BJC210 - £168.00
Canon BJC4100 - £254.00
Canon BJC610 - £383.00
Epson Stylus Mono 820 - £170.00
Epson Stylus Colour IIs - £208.00
Epson Stylus Colour 500 - £324.00
Epson Stylus Pro - £428.00
TurboDriver (with printer) - £47.00
Hard drives & kits - £Call
HP 5L laser printer - £419.00
HP 4V laser printer - £1808.00
Panorama digitisers - from £292.50
Parallel port 6x speed CD drive - £279.00
Pocket Book A-Link - £49.90
Power-tec SCSI 2 card - £195.95
RepIDE 32 card - £139.95

Other Software

Risc PC second slave - £116.30
Risc PC Syquest removable drives:
Please call for kits for other machines
EZ135 internal IDE kit - £124.50
EZ135 external SCSI, with i/f - £199.50
EZ230 internal IDE kit - £177.00
EZ230 internal SCSI, with i/f - £254.50
Sportster VI 33.6 - £195.00

Books & Manuals

Arc. Assembly Language - £14.95
BBC BASIC Manual - £21.95
Impression Tutorial Guide - £9.95
RISC OS 3 PRM - £104.00
RISC OS 3 PRM V5a - £32.75

Cables

We do hundreds of different cables.
Data switches are also available.
3.5mm stereo jack to same (2m) audio lead for additional output to Yamaha speakers etc. - £4.95
Midi cable (0.5m) - £2.20
MIDI cable (1m) - £2.50
MIDI cable (2m) - £3.50
MIDI cable (4m) - £5.25
MIDI cable (5m) - £5.95
MIDI gender changer - joins two MIDI cables together - £2.40
Null modem cable (2m) - £8.95
Null modem cable (5m) - £10.95
Null modem cable (10m) - £14.95
Two Phono plugs to same (e.g. PowerWAVE to Hi Fi) (1.2m) - £3.95
As above (5m) - £5.95
As above (10m) - £6.95
9 or 15-pin Scat leads - £10.95

Bargains

Other bargains are available.
A3000 User/Analogue Port - £30.00
CBX-K1, with PSU (ex-demo) - £99.00
A3010 1-2Mb (second hand) - £15.00
Acorn 14" monitor nylon cover - £4.95
Graphics on the ARM book - £10.00
RPC 14" monitor & single slice nylon cover - £10.95
RISC OS Style Guide - £5.00
Tech. Publications Style Guide - £5.00
RISC OS 3 PRM V5 - £15.00
YST-M5 speakers (ex demo) - £35.00
YST-MSW10 (in black) - £105.00
10/10 Dinosaurs - £10.00
Carnage Inc - £60.00
The Complete Animator - £10.00
Desktop Assembler - £35.00
Euclid, ArcLight, Spice, Tween & Mogul - £50.00
Jahangir Khan Squash, not RPC - £5.00
Sleuth V.1 - £35.00

We will attempt to match or beat any advertised price - even special offers.

All prices INCLUDE VAT & UK carriage

Official orders and callers welcome



MIDI – to most people this means a particular style of integrated record deck, cassette, FM tuner and CD player. Say this to any contemporary keyboard player or other musician involved in the new music technology and they will think you mean something quite different.

How it all started

The end of World War 2 saw musicians experimenting, making music with electronic oscillators and also recorded sounds. By the 1970's a large number of synthesisers had been developed, most of which were monophonic. It therefore became common to link several synth modules together under the control of one keyboard, using a standard known as CV or Control Voltage.

Unfortunately, different manufacturers were using different variations of the standard and it became necessary for the whole industry to agree to a standard. Finally the Musical Instrument Digital Interface 1.0 communications protocol was unveiled to the industry at the Los Angeles Music Fair in 1983. Since then every professional standard keyboard, sequencer or sampler has sockets on the back marked "MIDI".

MIDI and RISC OS

"What's this got to do with RISC OS machines?" I can hear you say. Simple, by fitting your machine with a MIDI interface you can control the vast array of MIDI compatible gear ranging from keyboard gear through samplers and sequencers to lighting rigs and mixing desks.

Why use MIDI?

"But there's already an internal sound system", you reply. Yes, and it is a pretty good one, but it can't compete with the dedicated processors inside modern MIDI equipment. The arrival of the RiscPC and applications such as the PD *TiMIDity*, the shareware *ReMIDI*, and ESP's software *Synth* enable users prepared to upgrade their systems sufficiently, to effectively use their machines as General

Midi maestro

Michael Cowgill presents
a brief guide to MIDI

Midi sound modules. Although the quality of sound is very much dependent on the sample set available, and the amount of RAM for storing the samples being used. It is a cheap way into MIDI compatibility for those unable to afford dedicated MIDI hardware.

Why not Tracker

Programs such as *Tracker* and *Digital Symphony* are too restricted in terms of the available sound channels. Compared with the 28 note polyphony of the Yamaha MU5 General MIDI module, or the 32 note polyphony of most other modern MIDI keyboards (128 and 64 note polyphony is available but not yet common), the 8 channels of *Digital Symphony* place severe restrictions on any chords you might want to play, and even with the 16 channels of *Desktop Tracker* you are struggling if you want to include strings and brass into your music as well as bass, guitar(s) and drums.

Setting the standard

Perhaps the most important reason of all for choosing to work with MIDI is that it is the Music Industry's standard format. A lot of nonsense is talked about industry standards, but it is of real use to know that a composition you have created in *Rhapsody* can be saved in MIDI format then loaded into *Sibelius*, or *Cubase* or *Notator*, or *Cakewalk Pro* and then played back. It isn't that the *Rhapsody* format is no good – each one of the music applications I have mentioned has its own format, but each one will also read and write in MIDI format because that is the one that all machines in the music industry can understand.



Jargon Box

MIDI	Musical Instrument Digital Interface
monophonic	Only able to play one note at once
polyphony	More than one note can be played at once
patch	Set of parameters which produce a particular sound
General MIDI	The latest MIDI standard which defines the instruments assigned to patch numbers
IC	Integrated Circuit – the blocks of silicon you see when you take the lid off your computer

£269.50*



Photodesk is the package which defines studio quality image editing and artwork on RISC OS machines. It is easy to use but has many powerful features, including a sophisticated colour management system (CMS) for the professional user.

Artworks renderer now available, also please contact us about the latest plug-ins and loader/savers!

£99.00*



At last a 3D modelling and graphics creation package that allows you to edit a single view! Even the most complex models can be created and manipulated with unrivalled ease and speed. Optimised hand-written ARM code routines boost performance in all areas and ensure maximum benefit from StrongARM! Many exciting new developments are in the pipeline, this is only the first in a series promised by Sincronia of Italy!

new!

PHOTODESK

£134.75*

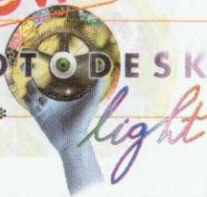

At exactly half the price, the new 'Light' version of Photodesk is offered as a way of accessing all the creative features of the application with the exception of a handful

of facilities provided to satisfy the needs of the full-time graphics professional: this means you can benefit from the full range of tools and effects, including plug-ins for less than the cost of the original Photodesk (v1).

£499.00**

Foto FUN!

DIGITAL COLOR PHOTO PRINTER

The amazing FotoFUN! is the first truly affordable printer to use dye-sublimation technology. This means that it is possible to get TRUE photographic quality output from your RISC PC. Real glossy photo prints that you would be proud to paste in your album are possible, and you are entirely in control; with the help of suitable image editing software like Photodesk your photos can be any way you want them!

*all prices include 17.5% VAT and UK P&P

**Includes 17.5% VAT, UK P&P driver and consumables

spacetech
imaging technology

Spacetech Ltd., 21 West Wools, Portland, Dorset, DT5 2EA

Tel +44 (0) 1305 822753 Fax +44 (0) 1305 860483

Email sales@spacetec.demon.co.uk Web: <http://www.digibase.com/spacetech/>

16MB Risc PC Memory

Special
October
Offer

ONLY £79.95

while stocks last
Bramingham Park Business Centre, Enterprise Way, Luton, Bedfordshire LU3 4BU.

Telephone 01582 584828 Fax 01582 562255

Yellowstone
Educational Solutions

Enhanced Performance ATA-2 Interface

RapIDE32 £139.83

A very fast 32 bit Risc PC Interface for hard drives and ATAPI CD-ROMs. Plug your existing drive to RapIDE and typically double its speed. Up to 400% improvement on the Risc PC motherboard controller. Firmware in FLASHROM. Up to 4 devices of any mix. Sustained data rates of up to 8MB/s. Peak data rates of 16MB/s on ATA bus. Ideal for multimedia sound and video.

RISC PC MEMORY

4 MB	£ 23.95.	Please call
8 MB	£ 49.95	for our
16 MB	£ 79.95	latest
32 MB	£209.95	prices!

RAPIDE/IDE DRIVE BUNDLES

Enhanced Performance ATA-2 Interface

RapIDE32 & ...

(1) Quantum Trailblazer 850MB	£269
(2) Quantum Fireball 1.28GB	£289
(3) Quantum Fireball 2.1GB	£359
(4) Quantum Fireball 3.2GB	£419

IDE DISC DRIVES

Quantum Trailblazer 850MB	£159
Quantum Fireball 1.28GB	£179
Quantum Fireball 2.1GB	£259
Quantum Fireball 3.2GB	£319

ATAPI CD-ROM DRIVES

Quad Speed (600KB/s)	£ 59
Eight Speed (1200KB/s)	£ 95
Price includes free driver with CDFS	

Mozart £70.44
DIGITAL AUDIO

Improved 16 bit Digital Audio Card and mixer for the Risc PC with superb reproduction and dynamics. Incorporates an oversampling tracking digital filter for the best sound quality independent of sample rate. The four channel mixer section combines CD-ROM and multimedia audio.

Risc PC
Audio Mixer £35.19

Four channel mixer for combining existing sound with CD-ROMs or multimedia audio.

Prices INCLUDE VAT but exclude p&p. Please add £2.35 for orders under \$100 (except Memory) and \$5.85 for orders \$100 and over.

Table 1: MIDI Status Bytes

Status Byte	Data Byte		
1st Byte Value	Function	2nd Byte	3rd Byte
80	Note off	Note Number	Note Velocity
90	Note on	"	"
A0	Polyphonic aftertouch	"	Aftertouch pressure
B0	Control change	Controller number	Control data
C0	Program change	Program #	NONE
D0	Channel aftertouch	Aftertouch pressure	
E0	Pitch Wheel	Pitch (LSB)	Pitch (MSB)
F0	System Exclusive	**	**

** Note: System Exclusive (data dump) 2nd byte= Vendor ID followed by more bytes and ending with EOX.

Under the skin

So how does it work then? A MIDI file is quite unlike a *Tracker* or *Digital Symphony* file. They contain digital images of the sounds together with the data for the order they should be played in. MIDI files consist of a series of instructions which are sent to the MIDI devices. Each instruction consists of a Status Byte followed by one or more Data Bytes. The Status Byte tells the device what action to take, and the Data Byte provides the parameters for that action. Table 1 gives information on the most commonly used Status Bytes. All numbers are in hexadecimal.

Implementation charts

The specific action taken by any one MIDI device is shown on the MIDI Implementation Chart which is supplied with all devices conforming to the MIDI standard. An example is shown in Table 2, without data, although some controller numbers are shown. The instrument's responses to the various MIDI messages are

shown in the blank columns next to each one, first of all whether it transmits this MIDI message, and also whether it receives and understands this message.

The final column is for remarks giving further information about its response to the message. For example in the remarks column for the Control Change message you may find a list of the names of the controllers that the numbers in the first

column refer to. Usually references to **Default** refer to the state of the machine when switched on. **Changed** or **Altered** refer to its state after a command has been issued to change this status.

Exclusive!

You may have noticed in the table of Status Bytes that there is a command for transferring System Exclusive information. System Exclusive messages are one of the most powerful aspects of MIDI. It is System Exclusive messages which enable sequencers to have initial parameters set up from a MIDI file, or initialise the parameters required from a General MIDI module.

They are vitally important as they enable system specific events to be sent via a universal system. They can also be used for synthesiser patch creation and control from a computer.

All the information you will need to know should be found in the manual for your keyboard in the section on MIDI. Some keyboards do not allow you to

RISCOS MIDI SWIs

Although there are others, everything you need for patch selection etc can be done with 2 SWIs:

- MIDI_TxByte
- MIDI_RxByte

Use MIDI_TxByte to transmit MIDI commands to your keyboard putting each byte in R0.

Use MIDI_RxByte to read MIDI info from your keyboard. Each byte will be held in R0

change the sounds, but even then, you can use the computer to make patch selection available at the press of a button.

Back to BASIC

A few lines of BASIC is all you need to implement most of the commands although there is nothing to stop you programming in C or ARM assembler if that is your favourite language. One word of warning. If you are writing patch editing software for older keyboards, it is possible to cause them to crash in such a way that only the manufacturer or a trained repair engineer can reset them. In some cases you can even blow ICs, so it is vital that you test the output from your program, before you start using it with your precious Juno or DX7.

You must also make sure that your program shuts down with an error if someone tries to use it with a keyboard it is not

designed for. This is quite easy as the normal MIDI protocol is for the System Exclusive byte &F0 followed by a byte which represents the manufacturer's ID. Most manufacturers then follow this with one or more bytes which identify the model of keyboard. You can check for these and tell the program to abort if any of these bytes are not correct. I hope that the BASIC examples which follow will give you enough to help you start writing your own MIDI control programs. MIDI control is only limited by your imagination, you can even use it for networks. **AU**

Disclaimer

Michael Cowgill and *Acorn User* admit no responsibility for damage caused as a result of the use or misuse of information obtained from this article.

BASIC examples

All status bytes are in hexadecimal, all data bytes are in denary:

```

Play a middle C
SYS "MIDI_TxByte",&90
SYS "MIDI_TxByte",60
SYS "MIDI_TxByte",48
FOR delay=1 TO 10000
NEXT
SYS "MIDI_TxByte",&80
SYS "MIDI_TxByte",60
SYS "MIDI_TxByte",0
Select patch number 10
SYS "MIDI_TxByte",&C0
SYS "MIDI_TxByte",10
Set Master Volume (General MIDI)
b%=0
DATA &F0,&7F,&7F,4,1,0
DATA &40,&F7,&100
:
REPEAT
READ b%
IF b%<&100 THEN
SYS "MIDI_TxByte",b%
ENDIF
UNTIL b%=&100
    
```

Note: This last example although it uses System Exclusive information does not use an ID byte as it is a Universal Real Time message defined in the General MIDI specification. Do not try to use on a non-General MIDI device.

Further info

Books – good starting points are:
Using MIDI
ISBN 0-88284-3540

The MIDI manual by David Miles Huber
ISBN 0-672-22757-6

Internet
The following web sites have relevant information or links:
<http://syy.oulu.fi/music.html>
<http://www.leeds.ac.uk/music.html>
<http://www.cs.ruu.nl/pub/MIDI/>
<http://www.eeb.ele.tue.nl/midi/>
<http://www-mitpress.mit.edu/Computer-Music-Journal/CMJ.html>

The Score Machine
I am always willing to help people trying to get started in MIDI and can be contacted by the following means:
E-mail: mcowgill@scoremac.demon.co.uk
The Score Machine Home Page:
<http://www.scoremac.demon.co.uk>
Tel: (01777) 701669

Model	Function	Transmitted	Recognised	Remarks	Date Version
Basic	Default				
Channel	Changed				
Mode	Default Messages Altered				
Note					
Number :	True Voice				
Velocity	Note ON Note OFF				
After	Key				
Touch	Channel				
Pitch Bend					
	0,32				
	1				
	6,38				
Control	7				
	10				
Change	11				
	64				
	84				
	100,101				
	120				
	121				
Prog					
Change :	True #				
System Exclusive					
System	Song Pos Song Sel				
Common	Tune				
System	Clock				
Real Time	Commands				
Aux	Local ON/OFF All notes OFF				
Messages	Active Sense Reset				
Notes					
	Mode 1	Omni On, Poly	Mode 2	Omni Mono	0 Yes
	Mode 3	Omni Off, Poly	Mode 4	Omni Mono	x No

Late Night Opening
Wednesday & Thursday
till 7.30pm

Open Sunday
11am to 4pm

**All prices quoted
Include VAT**

**FIRST
COMPUTER CENTRE**

HOWTO ORDER

Order by telephone quoting your credit card number. If paying by cheque please make payable to: "FIRST COMPUTER CENTRE". In any correspondence please quote a Phone Number, Post Code & Dept. Allow 5 working days for cheque clearance.

SHOWROOM ADDRESS:
DEPT. ACU, UNIT 3, ARMLEY
PARK COURT, STANNINGLEY
RD, LEEDS, LS12 2AE.

LOW COST DELIVERY

- 2-4 Week Days £3.99
- Next Week Day £5.99
- Saturday delivery £20.00

Delivery subject to stock availability
All prices include VAT @ 17.5%
• Large showroom with parking
• Multi-million pound company
• Overseas orders welcome
• Educational purchase orders welcome

OPEN 7 DAYS A WEEK
Lombard Finance available

Prices are correct at the time of going to press. Please check our latest prices before ordering. All sales are subject to our standard terms & conditions (copy available upon request). E&OE.

Telephone 0113 2319444

24 HR MAIL ORDER SERVICE FAX: 0113 231-9191
NEW! BBS Sales & Technical line TEL: 0113 231-1422
E-Mail sales@firstcom.demon.co.uk
www.demon.co.uk/firstcom

AUTHORISED REPAIR CENTRE

We offer a FREE quotation on your Acorn or any peripheral (monitors, printers etc.). A delivery tariff of just £5.00 is charged alternatively you can visit our showroom. We can also arrange a courier pickup at an additional cost of £11.00.

Hardware

Acorn Risc PC's

PC700

- 5Mb HD540 & AKF60 £1538.99
- 5Mb HD540/CD & AKF60 £1638.99
- 5Mb HD540 & AKF90 £1914.99
- 5Mb HD540/CD & AKF90 £2014.99
- 10Mb HD1.0G & AKF60 £1789.99
- 10Mb HD1.0G/CD & AKF60 £1889.99
- 10Mb HD1.0G & AKF90 £2164.99
- 10Mb HD1.0G/CD & AKF90 £2264.99

PC600

- 4Mb HD540 & AKF60 £1289.99
- 4Mb HD540/CD & AKF60 £1414.99
- 4Mb HD540 & AKF90 £1664.99
- 4Mb HD540/CD & AKF90 £1789.99

Dual Speed CD drives from £26.99
Six Speed CD drives from £54.99
16 Bit Sound Card £68.99
Extra Slice Case £115.99

Acorn A7000 Systems

0% Finance Acorn 20/20 Finance
Interest Free Credit
20% Deposit 20 Monthly Payments

PC Cards With Risc PC Separately

- SX-33 £115.99 £233.99
- DX2-66 £174.99 £292.99
- DX4-100 £233.99 £350.99
- 5x86 £350.99 £585.99

A7000 4Mb HD540 & AKF60 £1021.99
A7000 4Mb HD540CD & AKF60 £1139.99

Microvitec I438 Monitor
.28 dp, Multi-Sync
Only £264.99

Software

Delivery £1.50 per title or £3.99 for 4+

Entertainment Software	Title	£83.99	Bookshelf 96	£40.99
Alone in the Dark £25.99	Touch Typing £34.99	Dinosaurs £26.99	Encarta 96 £39.99	
Black Angel £26.99	Turbo Driver/B/Eps/HP Educational Software £42.99	MSDOS 6.22 & Windows Works V3 for Windows £67.99	Golf £26.99	
Cannon Fodder £22.99	Badger Trails £42.99	Reference Chambers Dictionary £35.99		
Cobalt Seed £22.99	Chrystal Rain Forest £42.99	Grolier Encyclopedia £15.99		
Cyber Chess £26.99	French Learning Series £19.99	Red Shift Astronomy II £39.99		
Darkwood £26.99	Noddy's Playtime £19.99	Dorling Kindersley Titles		
Fire & Ice £21.99	Oxford R/Tree Stage2 £39.99	Encyclopedia of Science £27.99		
Fist Lore £21.99	Oxford R/Tree More £39.99	Encyclopedia of Nature £27.99		
FTT Formula 2000 £23.99	Oxford R/Tree Stage3 £39.99	History of the World £27.99		
Global Effect £29.99	Rosie & Jim (Sneezes) £11.99	My 1st Incred. Dictionary £21.99		
High Rise Racing £21.99	Rosie & Jim (Duck) £11.99	PB Birthday Party £23.99		
Lemmings/More RiscPC £23.99	Talking Anim. Alphabet £11.99	Stowaway £24.99		
Rick Dangerous £14.99	10/10 Dinosaurs £13.99	The Way Things Work £27.99		
Saloon Cars Deluxe £26.99	10/10 Driving Test £13.99	The Ult. Human Body £27.99		
SimCity 2000 (A5000) £32.99	10/10 Early Essentials £13.99	The Ultimate Sex Guide £23.99		
SimCity 2000 (RiscPC) £32.99	10/10 Essential Maths £13.99	Virtual Reality Bird £23.99		
Simon the Sorcerer £34.99	10/10 Essential Science £13.99	Virtual Reality Cat £23.99		
Star Fighter 2000 £26.99	10/10 English £13.99	Top sellers on CD-ROM		
The Real McCoy 2,3 or 4 £16.99	10/10 French £13.99	Mortal Combat £31.99		
Time Machine £24.99	10/10 German £13.99	Will, Shatters TEK Wars £26.99		
Virtual Golf £19.99	10/10 Junior Essentials £13.99	Monopoly £27.99		
Wolfenstein 3D £25.99	10/10 Maths Algebra £13.99	Command & Conquer £32.99		
Application Software	10/10 Maths Geometry £13.99	Panic in the Park £29.99		
Arc Cadem 2 £53.99	10/10 Maths Numbers £13.99	Encarta 96 £33.99		
Arc Fax I.12 £37.99	10/10 Maths Statistics £13.99	Actua Soccer £28.99		
ArcTerm7 £65.99	10/10 Spelling £13.99	Rebel Assault £32.99		
Artworks 1.54 £115.99		PGA Golf 96 £33.99		
Hearsay II £75.99		Worms £27.99		
Home Accounts £31.99				
Copernicus Astronomy £29.99				
Impression Style £72.99				
Impression Publisher £117.99				
Sibelius 6 Version 3 £174.99				
Sibelius 7 Student ver3 £544.99				
Sibelius 7 Version 3 £999.99				

10/10 Education series
Any 2 for £25.99

PC CD ROM Software

- Schubert £37.99
- Strauss £26.99
- Stravinsky £37.99
- Ancient Lands £26.99

Windows 95

Microsoft Windows 95
From only **£90.99**

Win 95 CD £76.99
Win 95 upgrade CD £80.99

Acorn Spares

Acorn Mouse (Original) £29.99
A5000/A4000 Disk Drive £81.99
A3020 Disk Drive £100.99
A3010 Disk Drive £100.99
A3000 Disk Drive £81.99
RiscOS 3.11 Full Upgrade £86.99
RiscOS 3.11 No Manuals £43.99
MIDI Max (RiscPC & A5000) £80.99
MIDI User (A30x0 & A4000) £22.99
MIDI Cables (2x3m) £9.99

Repair & Fitting Service Available

2.5" H/Drives

CONNER Fujitsu Seagate

- 80Mb 2.5" IDE £84.99
- 130Mb 2.5" IDE £99.99
- 170Mb 2.5" IDE £104.99
- 250Mb 2.5" IDE £119.99
- 340Mb 2.5" IDE £129.99
- 540Mb 2.5" IDE £169.99
- A3010/3000 IDE Card* £69.99

*When Bought With Drive

3.5" H/Drives

Quantum TOSHIBA Seagate

- 540Mb 3.5" IDE £117.99
- 1.0Gig 3.5" IDE £152.99
- 540Mb 3.5" SCSI £151.99
- 1.0Gig 3.5" SCSI £235.99
- 2.0Gig 3.5" SCSI £345.99
- A3/A400 IDE Card £80.99
- A5000 2nd H/Drive Kit £19.99

Memory Modules

RiscPC/A7000 4Mb £22.99
RiscPC/A7000 8Mb £42.99
RiscPC/A7000 16Mb £96.99
RiscPC/A7000 32Mb £170.99

RiscPC VRAM 2Mb £169.99
With 1Mb Trade In £122.99

A3000 1Mb to 2Mb £65.99
A3010 1Mb to 2Mb £44.99
A3010 1Mb to 4Mb £99.99
A3020/A4000 2-4Mb £81.99
A5000 2Mb to 4Mb £72.99

Part X, your old Memory Call....

Printers

Canon

- Canon BJ30 £138.99
- Canon BJC70Colour £187.99
- Canon BJ210 £143.99
- Canon BJC4100Colour £222.99
- Canon BJC610 Colour £344.99
- Canon LPB 460 £279.95

EPSON

- Epson Stylus 500 £282.99
- Epson Stylus Colour IIs £166.99
- Epson Stylus 820 £132.99

CITIZEN

ABC Colour printer £129.99

star MICRONICS

- Star LC909 pin mono £79.99
- Star LC240 24 pin mono £93.99
- Star LC240C 24 pin Colour £108.99
- Star SJ144Colour £183.99

Accessories

Printer Switch Box 2 way £12.99
Printer Switch Box 3 way £17.99
Printer Stands (Universal) £4.99

1.8 Metre printer cable £4.99
3 Metre printer cable £6.99
5 Metre printer cable £8.99
10 Metre printer cable £12.99
SCSI Internal Cable £8.99
SCSI Cable 25D-50Cent £9.99

MULTI COLOUR
Disk labels
500 £6.99
1000 £9.99

Re-Mark-It disk labels x10 £1.99
10 Capacity box £0.99
50 Capacity lockable box £3.99
100 Capacity lockable box £5.49
*90 Capacity Banx box £11.99
*150 Capacity Posso box £20.99
100 Capacity CD holder £4.99

*add £3.00 delivery if purchasing just one Posso or Banx Box. Normal delivery when purchased with other product or when buying 2 or more.

Multi Media/CD ROM

RiscPC's (RISCOS 3.6 only) £79.99
8x Goldstar R580B £79.99
6x Goldstar R560B £64.99
4x Goldstar R542B £46.99

RiscPC's (RISCOS 3.5 only) £93.99
8x Optics Stingray £54.99
6x BTC CD drive £54.99

Comes with software driver disk
Dual IDE cable £9.99

CUMANA

Indigo CAA340i Quad Speed CD Drive £170.95
Indigo CAA340ia Quad Speed CD Drive £229.99
Indigo CAA300i Dual Speed CD Drive £134.99
Oscar (Parallel) 4 Speed CD Drive £222.99

Acorn CD Software

- APDL Clipart DTP 1 £18.99
- APDL Clipart DTP 2 £18.99
- Artworks £129.99
- Artworks Clipart 1/2 £20.99
- Cars-Maths in Motion £58.99
- Childrens Micropedia £87.99
- Creepy Crawlies £55.99
- Dune II £41.99
- Goldlocks £45.99
- Grannys Garden £34.99
- Hutchinsons Encyclopedia £31.99
- Oxford Reading Tree £39.99
- PDCE1 (Datafile) £24.99
- PDCE2 (Datafile) £24.99
- PDCE3 (Datafile) £24.99
- PDCE2 (APDL) £14.99
- Simon the Sorcerer £41.99
- Photobase Landscapes £55.99
- Understanding the Body £50.49

SupraFAX Modem

Sportster Vi

- Class 1 Fax
- Personal Voice Mail
- Fax on Demand
- Call Discrimination

BABT Approved

- 14,400 Data/14,400 Fax £98.99
- 33,600 Data/14,400 Fax £161.99

SupraFAX Modem 33.6

- Up to 115,200bps (v42bis)
- Silent & Adaptive Answer
- V34 Standard
- Class 1 & 2 Fax
- Unique LCD Display
- Flash ROM
- 5 Year Warranty

only £188.99

COMPUTER SHOPPER BEST BUY

SupraExpress 288

Only £153.99

- Up to 115,200bps (v42bis)
- LED Display
- V34 Standard
- NCom Software
- Class 1 Fax
- 5 Year Warranty

Supra modems are not BABT approved, however they perform as well & often out perform BABT approved modems. Supra Modems have a 5 year limited warranty.

Consumables

Ribbons

- Citizen Swift/ABC mono £3.99
- Citizen Swift/ABC colour £12.99
- Star LC90 mono ribbon £4.99
- Star LC101/100 mono £3.69
- Star LC101/100 colour £7.99
- Star LC240c colour £13.99
- Star LC240c mono £8.99
- Star LC240 mono £5.99
- Star LC24-10/200/300 Colour £13.99

Re-ink Spray for mono ribbons £11.99

Ink Cartridges

- Canon BJ10/Star SJ48 £17.99
- Canon BJ200/230 £18.99
- Canon BJ30 (3 pack) £12.99
- Canon BJC70 mono (3 pack) £10.99
- Canon BJC70 colour (3 pack) £17.99
- Canon BJC4000 colour (single) £16.99
- Canon BJC4000 mono (single) £6.99
- Canon BJC4000 mono high cap. £28.99
- Canon BJC600 mono high cap. £8.49
- Canon BJC600 colour £7.99
- Citizen Printiva Std. colours £6.49
- Citizen Printiva Metallic colours £16.49
- HP.Deskjet 500/550 Mono £22.99
- HP.Deskjet 500/550 Colour £24.99
- HP.Deskjet 660 double mono £23.99
- HP.Deskjet 660 colour £25.99
- Epson Stylus mono £27.99
- Epson Stylus colour £27.99
- Epson Stylus Col. II/S/820 Mono £17.99
- Epson Stylus Col. II/S/820 Colour £24.99
- Star SJ144 mono/colour (single) £8.99

Disks

- Bulk DSDD**
- 10 x £3.49 100 x £26.99
- 30 x £9.99 200 x £49.99
- 50 x £14.99 500 x £114.99
- Branded DSDD**
- 10 x £4.99 100 x £41.99
- 30 x £13.99 200 x £76.99
- 50 x £21.99 500 x £175.99
- Bulk DSHD**
- 10 x £3.99 100 x £29.99
- 30 x £10.99 200 x £55.99
- 50 x £16.99 500 x £129.99
- Branded DSHD**
- 10 x £5.99 100 x £44.99
- 30 x £15.99 200 x £82.99
- 50 x £23.99 500 x £189.99
- Disk labels x1000 £6.99**
- Disk labels x1000 £9.99**

Supra Price/Performance

PRIMA V34 Fax Modem

28,800 Baud Rate, BABT Approved
Connecting cable and Comms Software Provided.

Only £114.99

Supra Price/Performance

PRIMA V34 Fax Modem

28,800 Baud Rate, BABT Approved
Connecting cable and Comms Software Provided.

Only £114.99

Printer repair specialists call for quote

Save a fortune in running costs with your ink/bubble jet. Compatible with the HP Deskjet series, Canon BJ10/20/30/40/50/60/70/80/90/100/110/120/130/200/300/310. Star SJ48, Citizen Project and many others. Full range of colours available.

Most other makes available

Premier-ink Cartridge Refills

- Single refills (22ml) £6.99
- Twin refills (44ml) £12.99
- Three colour kit (66ml) £19.99
- Full colour kit (88ml) £24.99
- Bulk refills (125ml) £24.99

Printer repair specialists call for quote

Save a fortune in running costs with your ink/bubble jet. Compatible with the HP Deskjet series, Canon BJ10/20/30/40/50/60/70/80/90/100/110/120/130/200/300/310. Star SJ48, Citizen Project and many others. Full range of colours available.

Most other makes available

Premier-ink Cartridge Refills

- Single refills (22ml) £6.99
- Twin refills (44ml) £12.99
- Three colour kit (66ml) £19.99
- Full colour kit (88ml) £24.99
- Bulk refills (125ml) £24.99

Nursery Land

Geoff Preston looks at a new software package which takes traditional nursery rhymes, links them together and turns them into a soap opera

revisited

Question: What is the name of the sister of the candlestick maker in the nursery rhyme Rub-a-dub-dub? According to software house RESOURCE, the candlestick maker's name is Tom Wax, and his sister is Ruby (who is also the lady who rides

her horse to Banbury Cross)! RESOURCE are just about to launch a CD-ROM which not only tells the story of all the nursery rhyme characters so familiar to most of us, but also fills in some of the previously unknown background details. Not

the official background, but a plausible (in most cases) background never the less.

To research this article, I chose to visit RESOURCE rather than to simply receive a trial copy of the software to use at home. What immediately struck me when I arrived at RESOURCE's premises in Kegworth, Leicestershire was the enthusiasm from the team. The writers, artists and programmers have spent untold hours on this project over the last two years, and yet they were still full of excitement when describing it. When my three children sat at the computer to have a go, they were watched very closely to see if there was any way of improving the software to make it easier to use. Such is their commitment to produce the very best possible program.

The initial idea

Conscious of the need to put something back into the community, RESOURCE MD Brian Stevenson approached a nearby children's hospice and suggested producing a CD-ROM

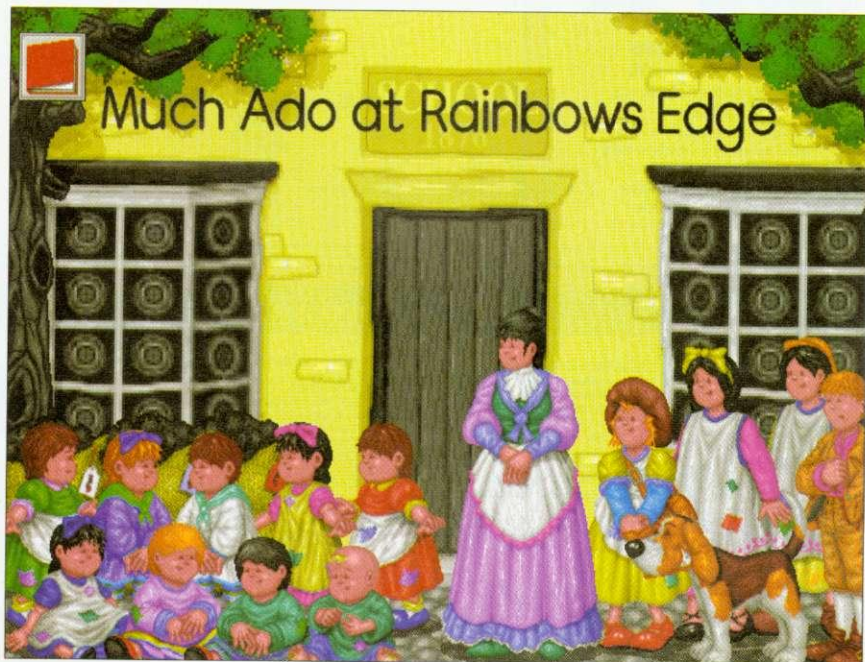

Outside the School at Rainbow's Edge

List of PSE topics covered in *Much Ado at Rainbow's Edge*

Ambition	Deception	Gender issues	Keeping calm	Name calling	Selfishness
Boasting	Dependability	Gossip	Keeping up	Predator and Prey	Shame
Boredom	Disability	Greed	appearances	Problems of parenting	Showing off
Bravery	Dissatisfaction	Growing older	Kindness to animals	Relationships (teacher/child)	Snootiness
Brotherly Love	Domination	Guilt	Laziness	Relationships (brother/sister)	Strangers
Bullying	Emergencies	Hatred	Loneliness	Revenge	Temptation
Caring for others	Encouragement	Helplessness	Love (Romance)	Routine	The big wide world
Chattering	Envy	Heroism	Love (Security)	Rudeness	The Truth
Cleanliness	Esteem	Honesty	Loyalty	Searching for knowledge	Theft
Conceit	Fear	Hunger	Lying	Self destruction	Vegetarianism
Confusion	Feelings	Identity	Madness	Self image	Worry
Conscience	Food chain	Inferiority	Mischief		
Courage	Forgetfulness	Initiation	Missing Out		
Cruelty	Forgiveness	Irresponsibility	Mothering		
Daring	Frustration	Justice			

with the view that some of the profits could be channelled into the hospice to provide some sort of regular income

for them. As the name of the hospice is The Rainbow, the town at the centre of the stories is called Rainbow's Edge. There will eventually be four CD-ROMs in the series, the first, *Much Ado at Rainbow's Edge*, will be followed by *Stories from Rainbow's Edge* by Christmas, with two further titles next year.

Aimed at Key Stage 1-2, *Much Ado at Rainbow's Edge* is primarily designed to help develop reading, but it goes a lot further. It's difficult to know quite where to start reviewing this software because there is just so much of it, with no obvious beginning or end. The final release will just about fill a CD-ROM, and that is only after a considerable amount of pruning.

At one point programmer Paul Jackson calmly announced that the 650Mbyte CD-ROM wasn't really big enough, and they are eagerly awaiting the next generation mass storage device. The reason for the need for huge quantities of disc space is that apart from the extraordinarily high quality graphics including animations, there are over 55,000 words of digitally recorded text. The recordings are by professional actors and actresses who really bring the characters to life.

The software opens with a scene inside a classroom beautifully drawn in the style that seems almost synonymous with nursery rhymes. The art work by Tod is superb. Each image, a work of art in its own right,

Inside the Classroom. Clicking on the map, the teacher, the desk or the cards will take the user to a story or activity.



has been carefully hand drawn, then-scanned, re-touched, and anti-aliased to help remove the effects of the square pixels on the curves.

Most of the objects within the classroom can be selected to take the user to the various activities. Clicking on the map on the wall zooms in to show the town of Rainbow's Edge, dominated by the Castle, which houses Old King Cole together with his fiddlers three, as well as all the King's horses and all the King's men. In the village you'll find the High Street with the butchers, the bakers and the candlestick makers. Out in the countryside is the crooked man's crooked house as well as the three little pig's house under construction. The grand old Duke of York is busy marching his 10,000 men up and

down the hill while in the woods Cock Robin's story unfolds.

All of the 120 characters and their families live in and around the village and moving the mouse pointer over the buildings shows who lives where. Clicking on a house will take the user to the story about the characters who lives there. The clever part here is that not only are the stories of the main characters included, but many stories have been created which links other members of the family to other nursery rhyme characters which have their own family. Tim Piper (the father of Tom as in Tom, Tom the Piper's son) is a kindly man who helps Mary rescue her lamb.

The nursery theme continues with countless interesting extensions to

It just isn't fair, thought the Great Owl as he perched on a sign.
 'No Owls ... it's discrimination, that's what it is... whatever that means.'
 They just didn't care two hoots about Owls and Pussy Cats.
 'We'll just have to swim to an island,' he said. 'Get married by a turkey.'

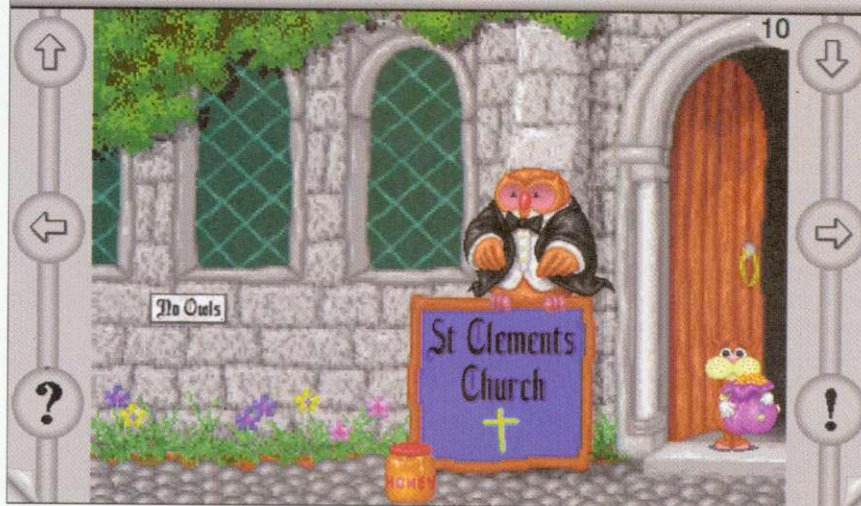

The stories are not just re-hashed rhymes but are new stories on the original theme. Some of the writing is very clever and very funny.

map offers the user one of eight activities. These range from questions about some of the events in the stories to Personal and Social Education activities.

To answer the questions one must first read the story and unless the story has been read, the relevant questions cannot be chosen. Teachers will be especially keen on the PSE activities, I'm sure. When chosen, a list of PSE topics is given, and clicking on a topic displays a list of stories which feature that topic. For example, if Bullying is chosen, the list of stories includes Georgie Porgie who, for those of us who recall, kissed the girls and made them cry.

Once again, back in the classroom, clicking on the teacher will display a pictorial database of all the characters in Rainbow's Edge. Clicking on a character will take the user to the appropriate story.

Whichever simple phrase is dreamt up to describe *Much Ado at Rainbow's Edge*, 'talking book' does not paint the full picture, although a large part of it can be used in this way. Apart from developing reading, associated activities include map work, databases, PSE topics and comprehension.

Also included on the disc will be several worksheets as Drawfiles which can be printed out, as and when they're required.

some of the stories. One amusing tale is about how Humpty Dumpty actually came to fall off the wall and precisely why all the King's horses and all the King's men couldn't put Humpty together again.

A novel twist on the talking story idea is that unlike most other talking books, these stories are not necessarily linear. In other words, you don't have to start at the beginning and work through to the end. When

another character appears in one of the scenes, the user can move the mouse pointer onto that character, select it and continue reading the story about that character. Later, while reading that story, another character may appear and that one can be selected so that that story may be followed.

All of the stories and characters are inter-linked in this way which greatly adds to the interest. Back in the classroom, clicking on the letters under the

Cast list of Much Ado at Rainbow's Edge

Five Current Buns	Jane Asher
Three Blind Mice	Peter Meakin
Little Jack Horner	Ian McMillan
Peter & Paul (Two little Dickie Birds)	Judy Browne
Proper Little Duck (looking for water)	Nannette Newman
Humpty Dumpty	Alan Bennett
Ride a Cock Horse	Pete Meakin
The Witch & The Broom	Karen Ascoe
There was an old woman	Julian Bleach
The Owl & the Pussycat	Graham Langley
The Beanstalk	Brian Patten
The Little Cat	Julian Bleach
Georgie Porgie	Anthony Andrews
Tom Tom the Piper's son	Ben Elton
Olde King Cole	Anthony Andrews
I wrote a letter to my love	Maggie Buck
The Old lady who lived in a shoe	Melee Hutton
Little Miss Muffet	Melee Hutton

Cast List of Stories from Rainbow's Edge

Little Bo Peep	Anneka Rice
Goldilocks(Three Bears)	June Whitfield
Crooked man	Jimmy Nail
Jack & Jill	Gary Lineker
Dr Foster	Judy Browne
Ding Dong Bell	Isla StClair
Rub a Dub Dub (Three Men in a Tub)	Mike Harding
Bobby Shaftoe	Victoria Wood
Billy Goats Gruff	Karen Ascoe
5 little Ducks	Nannette Newman
Farmer in his Dell	Derek West
12345 (once I caught a fish alive)	Rusty Lee
I Had a Little Nut Tree	Graham Langley
Mary Had a Little Lamb	Roddy Stuart
Sing a Song of Sixpence	Wendy Cope
Old Mother Hubbard	Julie Walters

Talking books

Unlike *Much Ado at Rainbow's Edge*, the second CD-ROM in the series, *Stories from Rainbow's Edge*, is a collection of talking books based on the original rhymes featured in the first CD-ROM. The texts for the stories, however, are not the original rhymes regurgitated for this program, but have been re-written and slightly expanded upon, although still following the original storyline quite closely.

The program opens with a scene in the library. The user moves to one of the thirty or so books on the bookshelf and having chosen the story, the user can either read it from the screen or have it read to them by the computer. The voices used to tell the stories are almost all of famous personalities who have given their time in the knowledge that some of the profits will go to the Rainbow Hospice.

Celebrities include Gary Lineker and Anthony Andrews, (both of whom are patrons of the Rainbow Children's Hospice), Jimmy Nail, Victoria Wood, Aneka Rice and Mike Harding to name but a few. Each of the readers have been perfectly matched to the story so that their regional accent enhances the text. Irish actor Derek West is wonderfully over the top as he reads the story of 'The Farmer in his Dell'. Animations add to the interest as well as to the humour which varies between subtle and groan-inducing.

In use

The software features switch control as well as keyboard control so that it can be used by most people regardless of age or physical impairment. I've said this before, but I think it's worth another airing. Although this is aimed primarily at school, parents will doubtless buy it for their children to use at home. To get the very best from this material, I feel very strongly that the parents should sit down with their children to work through the software. It is wholly inappropriate to buy material like this and give it to your child to keep them quiet while you pursue some other activity. You'll both get so much more from it going through it together.

Conclusion

It's hard to criticise this software. Even the unfinished pre-release ver-

sion I saw is so polished. The graphics are as good as any I've seen and the whole presentation has clearly been very carefully thought out. The digitised speech is crystal clear and read with real feeling. The storyline is varied and will not only appeal to youngsters, I'm sure parents will equally enjoy the 'off-the-wall' explanations of the some of the events.

The reading content goes well into Key Stage 2, which is intended to be up to 10 to 11 years of age. My only concern (and this is not a criticism) is the suitability of the nursery rhyme characters for children of this age.

My seven year old twins are just about past nursery rhymes. Simon in particular was not over-keen to spend too much time with the program, even though his reading would certainly have improved quite considerably by the sustained use of this material. Sally, on the other hand, was motivated by the characters and continues to gain a great deal from the program. Younger children, I feel, will be more comfortable with the material and indeed there are some exercises aimed at Key Stage 1 and pre-school. Once at that difficult age where street credibility becomes increasingly important, this software, sadly, is likely to have less appeal.

Of all the CDROMs I've reviewed, this rates as one of the best both in terms of original concept as well as

The talking books in *Stories from Rainbow's Edge* are read by some very well know personalities brilliantly matched to the character. One might even say, type-cast. (No offence Jimmy.)

The Rainbow Hospice

The Rainbow Hospice receives patients up to the age of 18 years. It is a self-run organisation which receives no funding whatsoever but relies solely on voluntary contributions. The value of the work they do for terminally ill children cannot be measured. If you would like to make a contribution please send it to Vanessa Cox, The Rainbow Children's Hospice, The Cope Children's Trust, COPE House, 6 Tower Street, Leicester LE1 6WS.

the way the project has been executed. The question is not 'Will it win an award?', but 'How many awards will it win?'.

The cost

Much Ado at Rainbow's Edge will cost £49.95 plus VAT whilst *Stories from Rainbow's Edge* will be £39.95 plus VAT, with a percentage of sales going to the Rainbow Hospice. In addition to the main products, there is to be a resource pack of photocopiable worksheets and a disc of high quality Drawfiles of all of the characters featured in the stories. The worksheets will be similar to those on the CD-ROM, but are being offered in this format primarily for people who do not have access to high quality printing. The cost of the resource pack has yet to be finalised but is likely to be about £12, with a similar percentage of the profits going to the Rainbow Hospice.

By the way, the reason Humpty couldn't be put back together again was..... No, you'll have to buy it to find out. **AU**

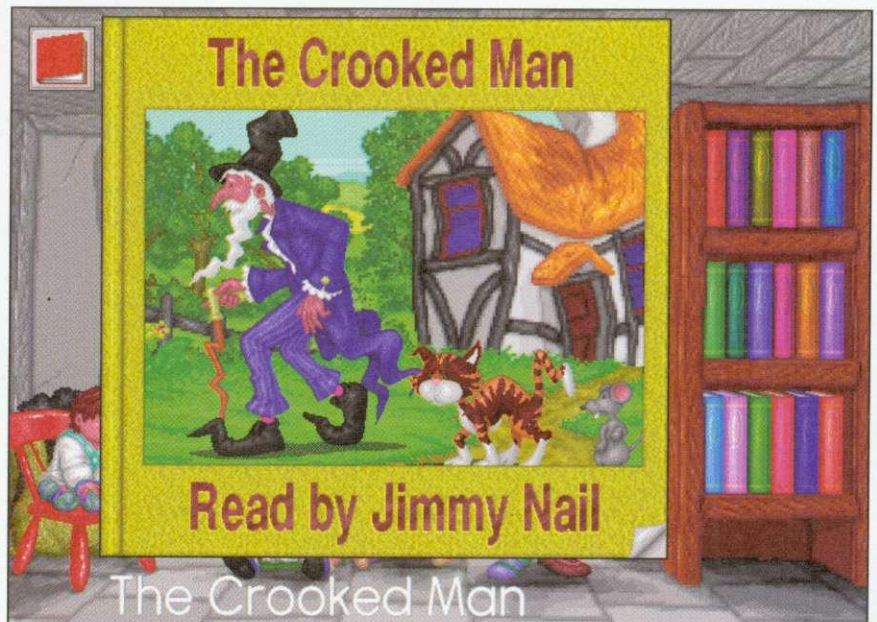



Kimberley Computers Ltd.
Dept ACU10, 73 Chapel Street, Leigh,
Lancashire, WN7 2DA UK.

Tel +44 (01942) 677777
Fax +44 (01942) 672300

Email Sales@kcsprem.demon.co.uk
or info@kcsprem.demon.co.uk

10x CD ROM Players

Suitable for Risc PC 600/700/A7000



Enhance your computer by adding a Super Fast 10 Speed CD ROM.

No extra hardware required, simply fits on to the existing IDE interface in your computer. 10 minutes to install, Acorn & PC drivers and audio lead supplied.

Supports CD-I, Mpeg, Kodak, etc 1500Kb/Sec <190Msec, 256Kb Cache, Quick Play Button, Multi Session.

CD ROM 10x £95.00 e £111.62

250Mb 2.5" Hard Drives

Suitable for A3000/A3010/A3020/A4/IBM Portables



Enhance your computer by adding a Fast 270Mb Hard Drive.

Allows the Acorn to run faster. Stores the equivalent of 312 full 800K Diskettes. Easy to fit, Instructions, Screws & Cable provided. Should take no more than 10 minutes. Requires Risc OS v3 or above.

Note: A3010/A3000 also require an IDE Interface

250Mb 2.5" IDE £99.00 d £116.32

RPC Upgrades

1Mb Vram upgradable	Ex Vat	Inc Vat
2Mb Vram	£55.00	£64.62 b
	£120.00	£141.00 b

4Mb 72 Pin Simm	£25.00	£29.37 c
8Mb 72 Pin Simm	£35.00	£41.12 c
16Mb 72 Pin Simm	£65.00	£76.37 c
32Mb 72 Pin Simm	£125.00	£146.87 c

540Mb IDE Hard Drive	£125.00	£146.87 d
850Mb IDE Hard Drive	£135.00	£158.62 d
1Gb IDE Hard Drive	£149.00	£175.07 d
1.2Gb IDE Hard Drive	£165.00	£193.87 d
1.6Gb IDE Hard Drive	£185.00	£217.37 e
2Gb IDE Hard Drive	£215.00	£252.62 e
540Mb SCSI Hard Drive	£135.00	£158.63 d
1Gb SCSI Hard Drive	£189.00	£222.07 e
2Gb SCSI Hard Drive	£245.00	£290.37 f
4Gb SCSI Hard Drive	£680.00	£799.00 f

PC Card SXL-33	£199.00	£233.82 e
PC Card DX2-66	£249.00	£292.57 e
PC Card DX4-100	£299.00	£351.32 e
PC Card 586-100	£499.00	£586.32 e

CPU FAN COOLER £8.50 £9.99 b

Did You Know that the chances of your ARM processor failing are much higher if you have a PC Card fitted. The PC Card raises the operating temperature of the ARM Card, to combat this, you will need a PC CPU Cooler. Highly Recommended

Hex (6x) CD Rom IDE	£75.00	£88.12 e
Oct (8x) CD Rom IDE	£75.00	£91.65 e
Quad (4x) CD Rom SCSI	£75.00	£88.12 e
Oct (8x) CD Rom SCSI	£185.00	£217.37 e

Arm 710 Upgrade	£125.00	£146.87 c
2nd Slice (inc PSU)	£99.00	£116.33 c
2 Slot Backplane	£30.00	£35.25 b
16 Bit Sound Upgrade	£59.00	£69.32 c
MIDI Port Module	£45.00	£52.87 c
User Port Analogue/MIDI	£99.00	£116.33 c
AKA32 Acorn SCSI Card	£125.00	£146.87 c
Std SCSI Card	£99.00	£116.33 c
Ethernet Card	£110.00	£129.25 c
Ethernet Card & Access+	£122.00	£143.35 c
RPC Technical Ref Man.	£50.00	£50.00 d

Heavy Duty Keyboard	£25.00	£29.37 e
RPC Std Keyboard	£25.00	£29.37 e
Keyboard Ext. Cable 2M	£6.50	£7.64 b
KCS Replacement Mouse	£10.00	£11.75 b
Acorn Mouse	£20.00	£23.50 b
Mouse Ext. Cable 2M	£6.50	£7.64 b
Monitor Ext. Cable 2M	£6.50	£7.64 b

14.4k Ext. Fax/Modem	£79.00	£92.82 e
28.8k Ext. Fax/Modem	£115.00	£135.12 e
14.4k Fax/Modem BAPT	£99.00	£116.33 c
28.8k Fax/Modem BAPT	£125.00	£146.87 c

15" FST Monitor 0.28dp	£225.00	£264.37 f
17" Monitor 0.28dp	£480.00	£564.00 f
17" Monitor 0.26dp	£535.00	£628.62 f
21" Monitor 0.26dp	£ Call	£ Call f

A5000 Upgrades

2-4Mb Mem Upgrade	Ex Vat	Inc Vat
4-8Mb Mem Upgrade	£89.00	£104.57 b
	£229.00	£269.07 d

540Mb IDE Hard Drive	£125.00	£146.87 d
540Mb SCSI Hard Drive	£135.00	£158.63 d
1Gb SCSI Hard Drive	£189.00	£222.07 e
2Gb SCSI Hard Drive	£545.00	£640.38 f
4Gb SCSI Hard Drive	£680.00	£799.00 f

All CD Roms are External
Twin (2x) CD Rom Par. £175.00 £205.63 e
Quad (4x) CD Rom scsi £175.00 £205.63 e
Oct (8x) CD Rom SCSI £245.00 £287.87 e

14.4k Ext. Fax/Modem	£79.00	£92.83 e
28.8k Ext. Fax/Modem	£115.00	£135.12 e
14.4k Fax/Modem BAPT	£99.00	£116.33 c
28.8k Fax/Modem BAPT	£125.00	£146.87 e

Keyboard Ext. Cable 2M	£6.50	£7.64 b
KCS Replacement Mouse	£10.00	£11.75 b
Acorn Mouse	£20.00	£23.50 b
Mouse Ext. Cable 2M	£6.50	£7.64 b
Monitor Ext. Cable 2M	£6.50	£7.64 b

Risc OS 3.1 Chipset	£29.00	£34.07 b
Risc OS 3.1 Full Kit	£50.00	£58.75 e
Risc OS 3.1 10 Pack	£290.00	£340.75 e
AKA32 Acorn scsi Card	£125.00	£146.87 c
Std SCSI Card	£99.00	£116.33 c
Ethernet Card	£110.00	£129.25 c
Ethernet Card & Access+	£122.00	£143.35 c
Float. Point Accelerator	£115.00	£135.12 e
User Port Analogue/MIDI	£95.00	£64.62 c

A4000 Upgrades

2-4Mb Mem Upgrade	£83.00	£97.52 b
-------------------	--------	----------

540Mb IDE Hard Drive	£125.00	£146.87 d
540Mb SCSI Hard Drive	£135.00	£158.62 d
1Gb SCSI Hard Drive	£189.00	£222.07 e

Keyboard Ext. Cable 2M	£6.50	£7.64 b
KCS Replacement Mouse	£10.00	£11.75 b
Acorn Mouse	£20.00	£23.50 b
Mouse Ext. Cable 2M	£6.50	£7.64 b
Monitor Ext. Cable 2M	£6.50	£7.64 b

AKA32 Acorn SCSI Card	£125.00	£146.87 c
Std SCSI Card	£99.00	£116.33 c
Ethernet Card	£110.00	£129.25 c
Ethernet Card & Access+	£122.00	£143.35 c

All CD Roms are External
Twin (2x) CD Rom Par. £175.00 £205.63 e
Quad (4x) CD Rom scsi £175.00 £205.63 e
Oct (8x) CD Rom SCSI £245.00 £287.87 e

14.4k Ext. Fax/Modem	£79.00	£92.82 e
28.8k Ext. Fax/Modem	£115.00	£135.12 e
14.4k Fax/Modem BAPT	£99.00	£116.33 c
28.8k Fax/Modem BAPT	£125.00	£146.87 e

A3010 Upgrades

1-2Mb Mem Upgrade	Ex Vat	Inc Vat
2-4Mb Mem Upgrade	£39.00	£45.82 b
1-4Mb Mem Upgrade	£79.00	£104.57 b
	£125.00	£146.87 c

IDE Interface for 2.5"	£55.00	£64.62 c
------------------------	--------	----------

170Mb IDE Hard Drive	£69.00	£104.57 d
270Mb IDE Hard Drive	£99.00	£116.32 d
540Mb IDE Hard Drive	£160.00	£188.00 d

Ext. Par. CD ROM 2x £175.00 £205.62 e

14.4k External Modem	£79.00	£92.83 e
28.8k External Modem	£115.00	£135.12 e
14.4k Fax/Modem BAPT	£99.00	£116.33 c
28.8k Fax/Modem BAPT	£125.00	£146.87 e

Ethernet Card	£110.00	£129.25 c
Ethernet Card & Access+	£122.00	£143.35 c
KCS Replacement Mouse	£10.00	£11.75 b
Acorn Mouse	£20.00	£23.50 b
Mouse Extension Cable	£6.50	£7.64 b
Monitor Extension Cable	£6.50	£7.64 b
Scart TV Lead	£8.50	£9.99 b
Microvitec 14" Monitor	£225.00	£264.37 e

A3000 Upgrades

1-2 Mem Upg Non Exp.	£25.00	£29.37 b
1-2 Mem Upgrade Exp.	£55.00	£64.62 b
2-4 Mem Upgrade Chips	£79.00	£92.82 b
1-4 Mem Upgrade	£114.00	£133.95 b

Serial Port upgrade	£19.00	£22.32 b
---------------------	--------	----------

IDE Interface for 2.5"	£55.00	£64.62 b
------------------------	--------	----------

170Mb IDE Hard Drive	£69.00	£104.57 d
270Mb IDE Hard Drive	£99.00	£116.32 d
540Mb IDE Hard Drive	£160.00	£188.00 d

14.4k External Modem	£79.00	£92.82 e
28.8k External Modem	£115.00	£135.12 e
14.4k Fax/Modem BAPT	£99.00	£116.33 c
28.8k Fax/Modem BAPT	£125.00	£146.87 e

Ethernet Card	£110.00	£129.25 c
Ethernet Card & Access+	£122.00	£143.35 c
KCS Replacement Mouse	£10.00	£11.75 b
Acorn Mouse	£20.00	£23.50 b
Mouse Extension Cable	£6.50	£7.64 b
Monitor Extension Cable	£6.50	£7.64 b
Scart TV Lead	£8.50	£9.99 b

Risc OS 3.1 Chipset	£29.00	£34.07 b
Risc OS 3.1 Full Kit	£50.00	£58.75 e
Risc OS 3.1 10 Pack	£290.00	£340.75 e
AKA32 Acorn SCSI Card	£125.00	£146.87 c
Std SCSI Card	£99.00	£116.33 c
Podule Caseing	£20.00	£23.50 b
PFM Interface	£15.00	£17.62 b
User Port Analogue/MIDI	£55.00	£64.62 c
800K Floppy Disk Drives	£38.00	£44.65 c

- 800K In Stock (dealer Enquires Welcome)

Syquest

Internal Drives	Ex Vat	Inc Vat
105Mb SCSI	£99.00	£116.32 e
EZ 135Mb SCSI	£89.00	£104.57 d
270Mb SCSI	£150.00	£176.25 e
270Mb IDE	£150.00	£176.25 e

External Drives & PSU	Ex Vat	Inc Vat
105Mb SCSI	£99.00	£116.32 e
270Mb SCSI	£160.00	£188.00 e

Cartridges	Ex Vat	Inc Vat
200Mb	£52.00	£61.10 b
270Mb	£36.00	£44.65 b
135Mb	£15.00	£17.63 b
40Mb	£37.00	£43.47 b

Scanners



Scanlight 256	£129.00	£151.57 e
Scanlight 256 Video	£189.00	£222.07 e

Flatbed A4 Colour	£270.00	£317.25 e
Mustek SP2400dpi scsi	£379.00	£445.32 e
Epson GT 5000 scsi	£429.00	£504.07 e
Epson GT 9000 scsi	£529.00	£621.57 f
HP Scanjet 4c scsi	£645.00	£757.87 f

Vision 24 Digitiser	£65.00	£76.37 e
Hi-Vision Digitiser A5k	£90.00	£105.75 e
ImageMaster & Twain	£25.00	£29.37 b

Speakers



80w Speakers & Amp	£25.00	£29.37 e
240w Speakers & Amp	£38.00	£44.65 e
300w 3D Speakers	£65.00	£76.37 e
Microphone	£7.00	£8.22 b
Clip On Microphone	£6.50	£7.64 b

Stylus 820



720 dpi Monochrome Inkjet Printer
Upgradeable to Colour - 3 Year Warranty
Epson Stylus 820 £155.00 £182.12 e

Stylus Colour IIs



720 dpi Colour & Black Inkjet Printer
3 Year Warranty, Interchangeable Cartridge
Epson Stylus Colour IIs £175.00 £205.82 e

Stylus Colour 500



720 dpi Photo Real Colour Inkjet Printer
- 3 Year Warranty, Double Density Black.
Prints on Plain, Coated & Glossy Paper & OHP's. Requires Bi Directional Ptr Port.

Supplied with Acorn Drivers on request.
Stunning Output - Turbo Driver Available
Stylus Colour 500 £230.00 £270.25 e

CLEARANCE

New	Inc Vat
Risc OS 3 PRM	£90.00 d
Scanlight 256 A3k/4k	£135.00 e
Pocket Book II 256k	£150.00 d
Pocket Book - Plotter	£10.00 b
Pocket Book - Schedule	£10.00 b
512k SSD Flash Disk	£50.00 b
256k SSD Flash Disk	£35.00 b
P Book Printer Adapter	£40.00 b
P Book Mains Adapter	£5.00 b
Joystick Int. A3020/4k/5k	£5.00 b
Welcome Guide A4000	£5.00 d
Risc PC Keyboard - Orig	£20.00 e
Panasonic KP444 1Mb u/g	£55.00 d
Printed Mouse Mats	£5.00 a
Safe N Tidy Plug Cover	£2.00 a
40/80 Trk 5.25 Disk Drive	£30.00 d

www.kimberley.com

The Kimberley Computers Web Site. Full of information about Acorn related products. Easy to use, fast loading graphics, email ordering, well laid out. A "Must Visit" site for all Acorn owners with Internet access.

Latest Prices are always to be found on the Web pages. Its updated on a weekly basis. Full Acorn Spares & Upgrades list, Cables, Printers, Consumables, Special Offers & Clearance items (www only).

If you don't have a modem and Internet access, check out our NEW LOW modem prices on the page opposite. We can help get you started. See you on the .Net!

<http://www.kimberley.com>

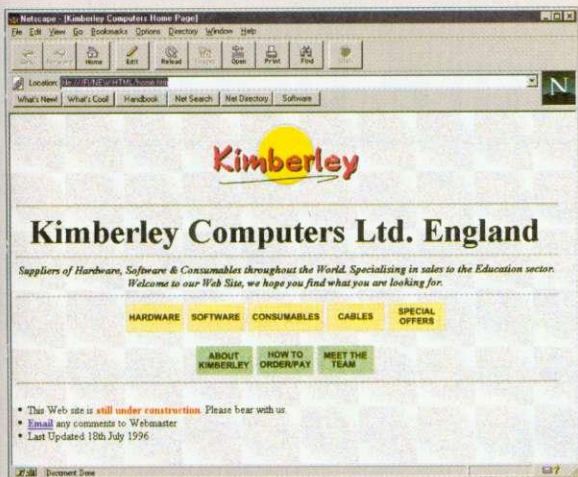

Extension Cables	Ex Vat	Inc Vat	Switch Boxes	Ex Vat	Inc Vat
5 Pin Din Ext. 2M	£6.50	£7.64 b	2 - 1 Printer (Centronics)	£11.75	£13.81 b
PS2/Keyboard Ext. 2M	£6.50	£7.64 b	4 - 1 Printer (Centronics)	£15.75	£18.51 b
15 Pin D vga/svga Ext. 2M	£6.50	£7.64 b	2 - 1 Printer (Serial 25 Pin)	£11.75	£13.81 b
9 Pin D Serial Ext. 2M	£6.50	£7.64 b	4 - 1 Printer (Serial 25 Pin)	£15.75	£18.51 b
25 Pin D Serial Ext. 2M	£6.50	£7.64 b	4 Comp. - Mon/PS2 Keyb	£15.75	£18.51 b
Acorn Mouse Ext. 2M	£6.50	£7.64 b	4 Comp. - Mon/5 Pin Keyb	£15.75	£18.51 b
Hot/Cold Mains Lead 2M	£5.00	£5.88 b	2 - 1 Serial Switch 25 Pin	£11.75	£13.81 b
			4 - 1 Serial Switch 25 Pin	£15.75	£18.51 b
			2 - 1 Scart Switch Box	£11.75	£13.81 b
			4 - 1 Scart Switch Box	£15.75	£18.51 b
			2 - 1 BNC Make b4 Break	£11.75	£13.81 b
			4 - 1 Printer Auto Sharer	£46.00	£54.05 b
Comms Cables			Dust Covers		
9/25 Pin - 9/25 Pin Laplink	£8.50	£9.99 b	Acorn A5000	£7.00	£8.22 b
BI Directional Data 25 Pin D	£11.00	£12.93 b	Acorn A4000	£7.00	£8.22 b
25 Pin D M-F RS232 2M	£6.50	£7.64 b	Acorn A3010/A3020	£4.50	£5.29 b
9 Pin D M-F RS232 2M	£6.50	£7.64 b	Canon BJ10 (Not with ASF)	£4.50	£5.29 b
9 Pin D - 25 Pin M Modem	£6.50	£7.64 b	Canon BJ200/4000	£4.50	£5.29 b
Archimedes Modem Cab 2M	£8.50	£9.99 b	Canon BJ600/610	£4.50	£5.29 b
			HP Deskjet 500 series	£4.50	£5.29 b
			HP Deskjet 600 Series & 850	£4.50	£5.29 b
Printer Cables			Inkjet Cartridges		
BI Directional 2M	£2.55	£3.00 b	Canon BC01	£14.00	£16.45 b
BI Directional 3M	£5.00	£5.88 b	Canon BC02	£15.00	£17.63 b
BI Directional 5M	£7.00	£8.22 b	Canon BJC4000 - Black Tank	£7.00	£8.22 b
BI Directional 10M	£12.00	£14.10 b	Canon BJC4000 - Col Tank	£12.00	£14.10 b
Serial Printer Cable 2M	£6.50	£7.64 b	Canon BJC4000 - Col/Bk. H	£21.00	£24.68 b
BBC Printer Cable	£6.50	£7.64 b	Canon BJC600 - Black Hcap	£8.00	£9.40 b
Centronics 36w-36w 2M	£6.50	£7.64 b	Canon BJC600 - Cyan	£6.20	£7.29 b
Centronics 36w-36w 2M	£8.50	£9.99 b	Canon BJC600 - Magenta	£6.20	£7.29 b
			Canon BJC600 - Yellow	£6.20	£7.29 b
			Canon BJC600 - Black	£13.50	£15.86 b
			Canon BJC800 - C/M or Y	£17.00	£19.98 b
			Canon BJ3070 - Black 3 Pk	£10.50	£12.34 b
			Canon BJ70 - Colour Tank	£14.50	£17.04 b
			Canon BJ300/330 - Black	£11.50	£13.51 b
			Integrex 132 - Black	£10.02	£11.77 b
			Integrex 132 - Colour	£18.00	£21.15 b
			Epson Stylus Col - Black	£12.00	£14.10 b
			Epson Stylus Col - Colour	£22.00	£25.85 b
			Epson Stylus Col II - Black	£12.00	£14.10 b
			Epson Stylus Col II - Colour	£22.00	£25.85 b
			Epson Stylus 800/1000 Black	£8.00	£9.40 b
			HP 310/Portable High Cap	£16.00	£18.80 b
			HP Deskjet 500 - Black	£16.00	£18.80 b
			HP Deskjet 500 - Tri Colour	£20.00	£23.50 b
			HP Deskjet 600 - Black	£19.25	£22.62 b
			HP Deskjet 600 - Tri Colour	£22.00	£25.85 b
			HP Deskjet 850 - Black	£19.25	£22.62 b
			HP Deskjet 850 - Tri Colour	£22.00	£25.85 b
			Olivetti JP150 - Black	£15.25	£17.92 b
			Olivetti JP150ws - Black Ref.	£32.00	£37.60 b
			Olivetti JP350/450 - Tri Col	£28.00	£32.90 b
Networking Cable/Accs					
BNC Cable/Plugs 2M	£5.00	£5.88 b			
BNC Cable/Plugs 3M	£6.00	£7.05 b			
BNC Cable/Plugs 5M	£8.00	£9.40 b			
BNC Cable/Plugs 10M	£13.00	£15.28 b			
BNC HQ Cable Reel 100M	£60.00	£70.50 b			
BNC Terminator	£2.00	£2.35 b			
BNC Solderless Crimp Plug	£1.25	£1.47 b			
BNC Strain Relief Boot	£0.50	£0.58 b			
BNC In Line Connector	£2.00	£2.35 b			
BNC T Piece	£1.50	£1.75 b			
BNC Wall Plate	£7.00	£8.22 b			
Internal Cables					
4cm IDE Cable 2.5"	£5.00	£5.88 b			
6cm IDE Cable 2.5" (Acorn)	£6.50	£7.64 b			
Twin Floppy Cable (PC)	£2.55	£3.00 b			
Single IDE Cable 18"	£2.00	£2.35 b			
Twin IDE Cable 18"	£2.55	£3.00 b			
Custom IDE Cable	ASK	ASK b			
3.5" Power Splitter	£2.55	£3.00 b			
5.25" Power Splitter	£2.55	£3.00 b			
CD Audio Cable Generic	£2.55	£3.00 b			
Acorn to Monitor					
A300/3000 - CM8833 Mk2	£8.50	£9.99 b			
A300/3000 - CM8833 Mk1	£8.50	£9.99 b			
A300/3000 - CM8833 Scart	£8.50	£9.99 b			
A300/3000 - Amstrad CPC	£8.50	£9.99 b			
A300/3000 - AKF30	£8.50	£9.99 b			
A300/3000 - AKF50/Msync	£8.50	£9.99 b			
A3010/4k/5k - CM8833 Mk2	£8.50	£9.99 b			
A3010/4k/5k - CM8833 Mk1	£8.50	£9.99 b			
A3010/4k/5k - CM8833 Scart	£8.50	£9.99 b			

CASIO QV-10A

LCD Digital Camera with TFT Active Colour Display.

£390.00 £458.25 E

Picture (right), taken by the Camera

Portable Camera, capable of storing 96 images, on 16 Mbit Flash Disk. Each picture can be downloaded to your PC / ACORN or MACINTOSH (specify)

Pictures taken in True Colour mode. Excellent results.

Full tilt n view lens, zoom facility, brightness control, automatic variable shutter speed

Built in Timer, instant playback.

Ideal for taking Product Photo Shots, Photos of groups, Field trips, Estate Agents, capturing experiments, etc.

No Film purchases or duplication costs at all. Simply press the button, and save to your PC /MACINTOSH (Acorn software - extra)

Video Output to TV screen. Remarkable peice of Hardware.

New Product -- * -- New Product

ALL FONTS CD

The best collection of fonts for Acorn/PC/Mac produced yet!

Over 1800 Acorn Fonts, over 2000 PC fonts, over 2000 Mac fonts. All on one CD Rom. A Must for any DTP enthusiast

Exclusive to Kimberley Computers

All Fonts CD **£39.00 b £45.82**

All Fonts CD & Font Posters **£49.00 e £57.57**

"Better Value than the PC Card"

Thinking of buying a 5x86 PC card for your Risc PC?

Think Again....

Why not buy a complete 5x86 or Pentium PC - Here's How:

Buy a Complete system with a monitor & keyboard switch box. This gives you complete compatability & it runs a lot faster than the PC card will. Has its own 8Mb RAM, a fast 8x CD ROM, Large Hard drive, fully expandable system. This system will outperform a Pentium P90!

Leasing for Schools can be arranged!

Other Higher Spec systems available, Call.

ONLY £499 & Vat

16Mb Option, add £35 & Vat.

Kimberley Computers Ltd

We can accept orders for goods in a variety of different ways:

By Telephone: Have your Credit/Debit card ready, our staff will take the necessary details to ensure your order reaches you As Soon as Possible, usually Next Day.

By Post: Kimberley Computers Ltd, 73 Chapel Street, Leigh, Lancashire, WN7 2DA

Post your order, giving FULL details, and most importantly, your phone number during the day. If paying by Credit card, we will need the full card number and Expiry date. If paying by cheque we will also need the Issue number, if paying by cheque, please make cheques payable to "Kimberley Computers Ltd."

By Email: sales@kcsprem.demon.co.uk

By Official Order Post or Fax the order to: 01942 672300

Terms: Goods Not Sold on a Trial basis. Prices & specs subject to change without prior notification. Goods are subject to availability. We reserve the right to charge a 30% Re-stocking Fee for Non Faulty goods returned. In the case of returns, phone before sending. We will not be liable for goods sent without proper Returns Authorization. We will do our best to help, but make sure you know what you are asking for and its suitability for use with your hardware configuration. E & OE.

FREE PARKING & Disabled Access

Tel: 01942 677777

8 Lines

Credit Cards are not debited until goods are ready for despatch. We are registered under the Data Protection Act, for your safety

"...excellent...strongly recommended."
 Archive May 1996

Over 600 Risc OS 3 Fonts

Half Price £26.50 inclusive



- | | | |
|--|---|---|
| ALBERSC
ALBERSC.OBLIQUE
ALPHR
ALPHR.OBLIQUE
ANCLOT
ANCLOT.BOLD
ANCLOT.BOLD.OBLIQUE
ANCLOT.OBLIQUE
Archeo
Archeo.Oblique
Arno
Arno.Oblique
ArtDeco
ArtDeco.Oblique
Balstrade
Balstrade.Oblique
BlackFace
BlackFace.Bold
BlackFace.Bold.Oblique
BlackFace.Oblique
Blacksmith
Blacksmith. Italic
BLOCSHIFP
BLOCSHIFP.OBLIQUE
BoutArt
BoutArt.Ext
BoutArt.Ext.Oblique
BoutArt.Oblique
BROADBIE
BROADBIE.OBLIQUE
BroadSheet
BroadSheet.Bold
BroadSheet.Bold.Ext.Oblq
BroadSheet.Bold.Oblique
BroadSheet.Oblique
CELESCA
CELESCA.BOLD
CELESCA.BOLD.OBLIQUE
CELESCA.OBLIQUE
Charley
Charley.Oblique
CIBARIOE | CIBARIOE.OBLIQUE
CIBARIOE
CIBARIOE.BOLD
CIBARIOE.BOLD.OBLIQUE
CIBARIOE.OBLIQUE
Clarence
Clarence.Bold
Clarence.Bold.Italic
Clarence.Italic
Collegum
Collegum.Bold
Collegum.Bold.Oblique
Collegum.Oblique
Confident
Confident.Bold
Confident.Bold.Oblique
Confident.Oblique
COPPER
COPPER.BOLD
COPPER.BOLD.OBLIQUE
COPPER.OBLIQUE
Designer
Designer.Bold
Designer.Bold.Oblique
Designer.Oblique
Distress
Distress.Bold
Distress.Bold.Oblique
Distress.Oblique
Dominic
Dominic.Bold
Dominic.Bold.Oblique
Dominic.Oblique
EastWood
EastWood.Bold
EastWood.Bold.Oblique
EastWood.Oblique
Embankment
Embankment.Oblique
EMERIC
EMERIC.OBLIQUE
Essential.Oblique
Foppik
Foppik.Oblique
Gothic.Modern
Gothic.Modern.Bold
Gothic.Modern.Bold.Ext.Oblq
Gothic.Modern.Bold.Oblique
Gothic.Modern.Oblique
Hayley
Hayley.Bold
Hayley.Bold.Oblique
Hayley.Oblique
Heraldew
Heraldew.Black
Heraldew.Black.Oblique
Heraldew.Bold
Heraldew.Bold.Oblique
Heraldew.Oblique
holman
holman.Bold
holman.Bold.Oblique
holman.Oblique
LWPR
LWPR.Bold
LWPR.Bold.Oblique
LWPR.Oblique
INQUIRY
INQUIRY.BOLD
INQUIRY.BOLD.OBLIQUE
INQUIRY.OBLIQUE
ISV.BoloniA
ISV.BoloniA.Italic
LW.DIARY
LW.DIARY.Oblique
ISV.Junior
ISV.Junior.Bold
ISV.Junior.Oblique
iSFLetter
iSFLetter.Oblique
iSFLetterA
iSFLetterA.Oblique
ISVSans
ISVSans.Bold
ISVSans.Bold.Oblique
ISVSans.Oblique
Hoonig
Hoonig.Oblique
Letapres
Letapres.Bold
Letapres.Bold.Oblique
Letapres.Oblique
Lofhorzian
Lofhorzian.Oblique
MACKINTOSH
MACKINTOSH.OBLIQUE
MARQUAND
MARQUAND.Bold
MARQUAND.Bold.Oblique
MARQUAND.Oblique
MILLERIA
MILLERIA.OBLIQUE
MODERNIZE
MODERNIZE.BOLD
MODERNIZE.BOLD.OBLIQUE
MODERNIZE.OBLIQUE
Ocarina
Ocarina.Bold
Ocarina.Bold.Oblique
Ocarina.Oblique
OldLegal
OldLegal.Oblique
OpenSerif
OpenSerif.Oblique
REJOICE | REJOICE.OBLIQUE
REVISION
REVISION.Bold
REVISION.Bold.Oblique
REVISION.Oblique
ROMAN.ENGRAVED
ROMAN.ENGRAVED.OBLIQUE
Rounderif
Rounderif.Oblique
Saloon
Saloon.Oblique
Savonius
Savonius.Cursive
Savonius.Oblique
SerifScrip
SerifScrip.Bold
SerifScrip.Bold.Ext.Oblq
SerifScrip.Bold.Oblique
SerifScrip.Oblique
Signage
Signage.Oblique
Shimline
Shimline.Oblique
Stapleton
Stapleton.Oblique
StyMartin
StyMartin.Oblique
StyMary
StyMary.Bold
StyMary.Bold.Oblique
StyMary.Oblique
StyMary
StyMary.Oblique
SuperSans
SuperSans.Bold
SuperSans.Bold.Oblique
SuperSans.Oblique
Swinley
Swinley.Bold
Swinley.Bold.Oblique
Swinley.Oblique |
|--|---|---|

- Full latin 1 character sets including Welsh
- Fully Scaffolded with kerning pairs
- Installer for EasyFont, FontDIR & IFonts
- Serif, SansSerif, Script, Decorative & Gothic
- Risc OS 3.1 or later & Hard Disk required
- Full samples available in our catalogue
- Compatible with any other Outline fonts
- 75 families - 13Mb hard drive space required
- Supplied on 800K floppy disks for all machines
- Suitable for Danish, Dutch, English, Faroese, French, German, Icelandic, Irish, Italian, Norwegian, Portuguese, Spanish, Swedish and Welsh.
- Can be used with ANY application that uses outline fonts
- Includes accented letters, symbols, ligatures, diphongs etc
- A complete high quality font library
- Available for immediate dispatch

iSV Products All prices include UK carriage
 86 Turnberry, Home Farm **Overseas orders please add £2.00**
 Bracknell, Berks, RG12 8ZH
 Tel 01344 55769
 All details are correct at the time of going to press E&OE. All Trademarks are acknowledged
 Discounts are based upon prices exc p&p

picture book 2

6 high-quality programs specially designed to help pre-school, primary school and special needs children with Reading, Spelling and Counting - enjoyably and very effectively!

- **AlphaBook** • **Snap** • **WordMatch**
- **Count em** • **Spell It** • **FlashCard**



Each program uses Alphabet files with professionally drawn graphics, sound effects and spoken words and offers many setting choices to suit each child's ability. For RISC OS 3.1 or later. **£35.00**
 Site licence: £105.

Draggie

The Professional Application Launcher

For easy on-screen access to your most frequently used files and applications **Draggie** is the professional answer. Cut out constant clicking with these easy to install pull-down menus. The best way yet to organise your computer screen, your files and your time. **£12.00**

Notice Board

"..for rolling presentations Notice Board excels."
 Acorn User

Using Draw and Artworks files **Notice Board** enables you to create multi-page, poster-like presentations to run unattended in any location. Widely used in schools, **Notice Board** provides a colourful, constantly changing information point that is also ideal for information/sales messages at conferences and exhibitions, libraries, reception areas, etc. **£35.00**
 For use with RISC OS 3.1 or later.

Montage

Creative Fractal Art

"...decidedly the most original and unusual package I have seen for a very long time.....once you've digested what the instructions say, Montage is a fascinating and enthralling program."
 RISC User

Create your own stunning fractal art pictures quickly and easily with Montage. Working in interactive mode Montage builds the images as you work. Requires RISC OS 3.1 minimum 2mb, 4mb for hi-res pictures. **£45.00**

MultiLink

Transfers data effortlessly between 8-bit BBC and all RISC OS 32-bit computers. Easy to use click and drag operation. *With serial cable* **£29.95**

The Really Good Software Company
 39 Carisbrooke Road, Harpenden, Herts. UK AL5 5QS
 Tel/Fax: 01582 761 395 Email: rgsc@turnbull.compulink.co.uk
 No VAT or post/packing. Cheques, with order please, made payable to the company. Official orders welcomed.

Making movies

Leo Telling looks at Videodesk and the future of desktop video

I've seen the future of desktop video and it works... well nearly. *Videodesk*, the long awaited video digitiser/compressor/editor package from Irlam Instruments is nearing completion, and a fully working, although not fully featured, version should be on display at Acorn World.

Solid base

Jim Irlam and his team have rather sensibly opted to build up the features in *Videodesk* from a solid base, rather than show something that does everything but has more crashes than the M25 in the fog. By the time Acorn World comes round *Videodesk* should be offering full drag and drop video editing at a quality previously unseen in the Acorn market.

Consisting of three basic ingredients *Videodesk* is much more than the sum of its parts. The card itself is the heart of the system, a professional quality video digitiser and compressor which uses Irlam's own moving JPEG compressor engine.

The Risc TV overlay card backs up the digitising side by allowing moving video to be mapped directly on to the screen, without sacrificing any precious processor bandwidth. Finally, the editing software ties the bundle of goodies together by presenting a powerful, yet simple to use, editor with the now standard time-line style interface.

Something special?

But why care about *Videodesk* when *Eidoscope* and *CineWorks* do pretty much everything? Well, when you see what it can do you may well shed a few real tears as you throw your old video editing kit in the bin.

Videodesk not only promises to deliver real non-linear editing at better than VHS quality, it actually does it. And the cost of this mini-marvel? Less than the cost of two edit spec VHS machines, but a little more than a decent camcorder – the final price

is likely to be around £1,200. However, when used with a conventional camcorder (Hi8, Video 8, VHS, or even one of the new digital formats) it will most likely be the camcorder that limits the quality of your work – not *Videodesk*.

What can it do?

Videodesk can record and compress, full frame, 24-bit video direct to disc in real time. Not the tiny 160 by 128 pixels of a standard replay file, but

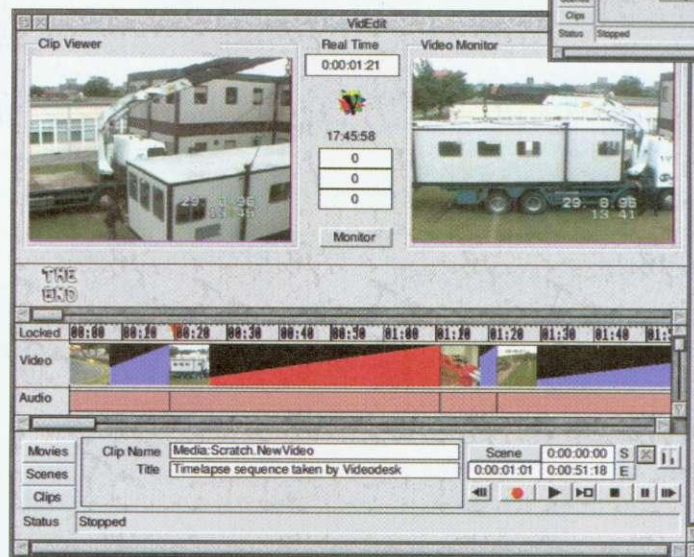

monstrous 768 by 576 pictures. When played back through a second external monitor (a domestic TV will do) the resulting pictures are stunning.

Add to that the facility to make audio and video edits, fiddle with the sound, add captions and video effects, and I can only conclude that affordable desk top video has finally arrived. *Videodesk* might not be in the price range of the casual dabbler, but anyone who takes home movies seriously, or has an interest in the world of professional video will be more than interested.

Speed and image quality

The pre-release version I saw was pretty solid, and although it didn't offer all the bells and whistles of *Eidoscope* or *CineWorks* it blew both of them away as

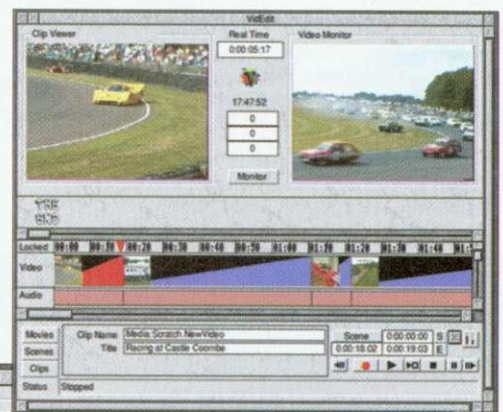

far as speed and image quality are concerned. By using its proprietary moving JPEG compression codec and a special overlay card Irlam has bypassed the bottleneck of the Risc PC bus, allowing full screen compression and playback – without the aid of a StrongARM.

In order to demonstrate the power of *Videodesk*, Irlam is currently producing a short video which, as well as showing off the features of both hardware and software, has also being completely produced using *Videodesk*.

Again it is hoped this will be ready in time for Acorn World. Irlam seems committed to developing the project to compete with the big players in the game, and at this stage the signs are that Acorn is also betting on the system becoming a winner. Watch this space... AU

Contact details

Irlam Instruments
Brunel Institute of Bioengineering
Brunel University
Uxbridge
Middlesex
UB8 3PH
Tel/fax: (01895) 811401
E-mail: info@irlam.co.uk

One Stop Storage



Hard Drives

	Exc. VAT	Inc. VAT
A3000 120Mb IDE + User Port. Internal	£145	£163
A3000 170Mb IDE + User Port. Internal	£159	£187
A3000 250Mb IDE + User Port. Internal	£179	£210
A3000 410Mb IDE + User Port. Internal	£259	£304
A3010 120Mb IDE. Internal	£135	£159
A3010 170Mb IDE. Internal	£149	£175
A3010 250Mb IDE. Internal	£169	£199
A3010 410Mb IDE. Internal	£249	£293
A3020 120Mb IDE. Internal	£85	£100
A3020 170Mb IDE. Internal	£99	£116
A3020 250Mb IDE. Internal	£119	£140
A3020 410Mb IDE. Internal	£199	£234
A300/400/5000/A7000/RISC PC		
512Mb IDE Drive. Internal	£112	£132
850Mb IDE Drive. Internal	£129	£152
1.2 Gb IDE Drive. Internal	£139	£163
1.6 Gb IDE Drive. Internal	£189	£222
2.5 Gb IDE Drive. Internal	£209	£246
SCSI DRIVES (INTERNAL)		
540Mb SCSI Drive. Internal	£125	£147
850Mb SCSI Drive. Internal	£139	£163
1.2 Gb SCSI Drive. Internal	£199	£234
2.0 Gb SCSI Drive. Internal	£329	£387
4.0 Gb SCSI Drive. Internal	£call	£call
SCSI DRIVES (EXTERNAL)		
540Mb SCSI Drive. External	£165	£194
850Mb SCSI Drive. External	£179	£210
1.2 Gb SCSI Drive. External	£239	£281
2.0 Gb SCSI Drive. External	£369	£434
4.0 Gb SCSI Drive. External	£call	£call

Syquest Drives

	Exc. VAT	Inc. VAT
270Mb IDE Drive. Internal	£179	£210
270Mb SCSI Drive. Internal	£179	£210
270Mb SCSI Drive. External	£319	£375
270Mb Syquest Cartridge	£38	£45

Optical Drives

	Exc. VAT	Inc. VAT
230Mb SCSI Drive. Internal	£325	£382
230Mb SCSI Drive. External	£365	£429
640Mb SCSI Drive. Internal	£call	£call
640Mb SCSI Drive. External	£call	£call
230Mb Optical Cartridge	£12	£14
640Mb Optical Cartridge	£call	£call

Memory

	Exc. VAT	Inc. VAT
A3000 1-2Mb	£39	£46
A3000 1-4Mb	£39	£116
A3010 1-2Mb	£38	£45
A3010 1-4Mb	£39	£116
A3020 2-4Mb	£74	£87
A4000 2-4Mb	£74	£87
A5000 2-4Mb	£69	£81
A5000 4-8Mb	£199	£234
RISC PC 4Mb	£35	£41
RISC PC 8Mb	£53	£62
RISC PC 16Mb	£93	£109
RISC PC 32Mb	£235	£276

Scanners

Epson GT-5000 300x300 dpi	£365	£429
Epson GT-9000 600x600 dpi	£599	£704
UMAX S6E 300 x 600 dpi	£299	£351

Upgrades

	Exc. VAT	Inc. VAT
A300/400 IDE Card + User Port	£69	£81
A3000 IDE Card + User Port	£69	£81

A3010 IDE Card	£57	£67
SCSI Card (All Acorn Computers)	£85	£85
RISC OS 3 (Chips Only)	£32	£38
RISC OS 3 (Chips, Software & Manual)	£59	£69
SCSI 25 to 50 Way 1 Metre	£10	£12
SCSI 50 to 50 Way 1 Metre	£10	£12
SCSI Terminator	£10	£12
SCSI 3 Connector Ribbon Cable 1 Metre	£10	£12
SCSI 4 Connector Ribbon Cable 1 Metre	£12	£14
IDE 3 Connector Ribbon Cable 1 Metre	£8	£9

Multiple SCSI Storage Solutions by DATA CHASER
Any combination of 2 to 8 SCSI Devices in one Professional SCSI Enclosure



Payment Cards Welcome



CD-ROM Drives

QUAD SPEED CD SPECIAL £45.00

	Exc. VAT	Inc. VAT
BARE INTERNAL CD-ROM DRIVES FOR RISC PC & A7000		
RISC PC/A7000 x4 Speed Internal IDE	£45	£53
RISC PC/A7000 x8 Speed Internal IDE	£call	£call
RISC PC/A7000 x4 Speed Internal SCSI	£105	£124
RISC PC/A7000 x8 Speed Internal SCSI	£call	£call
INTERNAL SCSI CD-ROM KITS FOR RISC PC & A7000		
RISC PC/A7000 x4 Speed Internal with SCSI Card	£189	£222
RISC PC/A7000 x8 Speed Internal with SCSI Card	£call	£call
EXTERNAL SCSI CD-ROM KITS SUITABLE FOR ALL ACORN COMPUTERS INCLUDING SCSI CARD		
x4 Speed External (Complete Kit)	£249	£293
x8 Speed External (Complete Kit)	£call	£call
CD-ROM TOWERS (SCSI)		
x4 Speed SCSI 2 Drive Tower System	£289	£340
x8 Speed SCSI 2 Drive Tower System	£call	£call
x4 Speed SCSI 4 Drive Tower System	£540	£635
x8 Speed SCSI 4 Drive Tower System	£call	£call
x4 Speed SCSI 6 Drive Tower System	£799	£939
x8 Speed SCSI 6 Drive Tower System	£call	£call

i-Cubed Network Cards

Etherlan 102 for A3000/3010/3020/4000 (Podule Slot Combo)	£119	£140
Etherlan 210 for A3020/A4000 (Network Slot 10Base 2)	£125	£147
Etherlan 211 for A3020/A4000 (Network Slot 10Base T)	£126	£148
Etherlan 512 for A5000 & A400/300 (Podule Slot Combo)	£119	£140
Etherlan 513 Fibre Optic Adaptor for A5000 & A400/300	£389	£457
Etherlan 522 for RISC PC with DMA for improved Performance	£145	£170
Etherlan 523 Fibre Optic Adaptor for RISC PC 600/700 & A7000	£289	£316
Etherlan 602 for RISC PC & A7000 (Podule Slot Combo)	£99	£116
Etherlan 102/A+ for A3000 with FLASH ROM (Acorn Access +)	£139	£163
Etherlan 211/A+ TenBase2 A3020/A4000 FLASH ROM (Acorn Access +)	£145	£170
Etherlan 211/A+ TenBaseT A3020/A4000 FLASH ROM (Acorn Access +)	£145	£170
Etherlan 512/A+ Combo for A5000 FLASH ROM (Acorn Access +)	£139	£163
Etherlan 602/A+ for RISC PC FLASH ROM (Acorn Access +)	£115	£135
AVIGNON ETHERNET BRIDGE PRODUCTS		
E102B A3000 Avignon Bridge Card	£169	£199
E200B TenBase2 A3020 Avignon Bridge Card	£179	£210
E201B TenBaseT A3020 Avignon Bridge Card	£179	£210
E512B A5000 Avignon Bridge Card	£169	£199
E602B RISC PC & A7000 Avignon Bridge Card	£149	£175
Etherlan/B Avignon Software Upgrade for any above Etherlan Card	£49	£58

Technology Matrix supply a full range of i-Cubed Network products. Please call for prices

Equipment, prices and backup that make Technology Matrix the preferred supplier

Technology Matrix Hot Line 0161 320 0000
89a Stockport Road, Denton Manchester M34 6DD. Fax: 0161 320 3210

Full INTERNET Access

Zy-Base

Own email address
Full, unlimited access to the World Wide Web
No on-line charges, local call rates,
FREE Acorn start-up software, FREE tech support
Usually **£20** set-up & **£120** per annum

But we are also including **500K of web space FREE**

(for non-commercial use)

Special Offer

6 Months **Only £60** + VAT

1 Full Year **Only £99** + VAT

Call us now on: 01392 209500

Why choose Zynet?

- Recently voted **No 2** in the Industry standard Netmarque Tests
- Quality reliable service
- Customer responsive policy
- 10 years of Acorn experience
- FREE Acorn compatible start-up pack
- FREE, friendly technical support
- Range of services for home users
- Business solutions
- School and college service
- Easily upgraded accounts



The Quality Internet Provider

Zynet Limited ● Minerva House ● Baring Crescent ● Exeter ● EX1 1TL
Fax: 01392 421762 ● Email: sales@zynet.net ● WWW: http://www.zynet.co.uk/

So far, most of the HTML I've described has been standard, normal HTML. It will work on all browsers, you need to have a good grounding in it to write HTML, but it's unlikely to win you any awards for artistic merit. It gives you very little control over how your HTML will look – decisions of that sort are all taken by the browser, and you trust it to make sensible choices.

There's absolutely nothing wrong with HTML of this sort, and there are thousands of commonly-read pages on the Web that use it. But, if you want to, there are plenty of ways to change how your HTML appears. They're not standard, and they won't work on all browsers, but usually the worst that happens is that they're ignored by older browsers. Therefore, provided that you don't rely completely on them, there's no harm in using them.

Alignment

In standard HTML, paragraphs, headings and so on aren't tied to any particular alignment. Paragraphs are usually aligned left, with some headings being aligned centrally. However, you can add an **align** attribute to paragraph and heading tags which on many browsers will change the alignment. They can be aligned "left", "center" (sic) or "right" – note that all HTML is spelt the American way.

Older versions of *Netscape Navigator* (a non-Acorn browser) didn't support this, but invented a `<center></center>` tag pair to perform the same job – most browsers support this as well, but it's generally better style to write:

```
<p align="center"> ... </p>
```

than:

```
<center><p> ... </p></center>
```

The corresponding `<right></right>` tag

Colourful pages

Extensions to standard HTML are discussed in this issue's HTML tutorial by David Matthewman

pair exists, but is rarer. The use of **align="left"** and **align="right"** with the `` tag is subtly different. With images, the image is aligned either to the left or the right of the screen, and text flowed round it – rather as it would be in a frame in a DTP package.

Unfortunately, none of the current Acorn browsers supports this attractive effect, although the next release of the *ANT Internet Suite* will.

Colours in HTML

When specifying a colour in HTML, it is given as a three-byte hex number "#rrggbb", where rr is the red intensity, gg the green and bb the blue. This means that #000000 is black, #ffffff white, #ff0000 red, #ff9900 orange and so on (the colours

aren't case-sensitive). The individual bytes can take any value, so that in theory you can specify the full 24-bit range, although in practice the display will be limited by whatever screen mode you are in, with a judicious allowance for dithering on some browsers.

The hash sign '#' in front of the number is compulsory, and it is safer to enclose them within double quotes. Colours on RISC OS are commonly specified as three-byte numbers, so this system should be reasonably easy to learn, provided that you know your hexadecimal. There is a move to have 16 standard 'named' colours in HTML, but until more browsers support them it's probably not a good idea to use them. In any case, the proposed colours are based on the Windows standard palette colours, so they should probably be boycotted on principle.

So, now you know *how* to specify colours in HTML, the next question is *where*. The most common place that colours are used in HTML is in the `<body>` tag, to set the background and text colours. Before discussing this, I need to mention another use of the `<body>` tag – to set a background image.

Body tagging

In standard HTML, the `<body></body>` tag pair marks off the HTML to be displayed, and has no other function. However, most browsers now allow you to specify a background image for the page in the tag by using the **background** attribute. If you write:

```
<body background="image.gif">
```

then the file *image.gif* will be used as the background to the page. If the file is smaller than the page (it usually is) then it is tiled to fit – there is no option in HTML to scale or centre it as there is with tiles on the Desktop.

Obviously, if you use a dark image, your text may not show up very well against it if it is rendered in the default black. For this reason, if you use a background image, you should always set the five other attributes that set the text colour as follows:

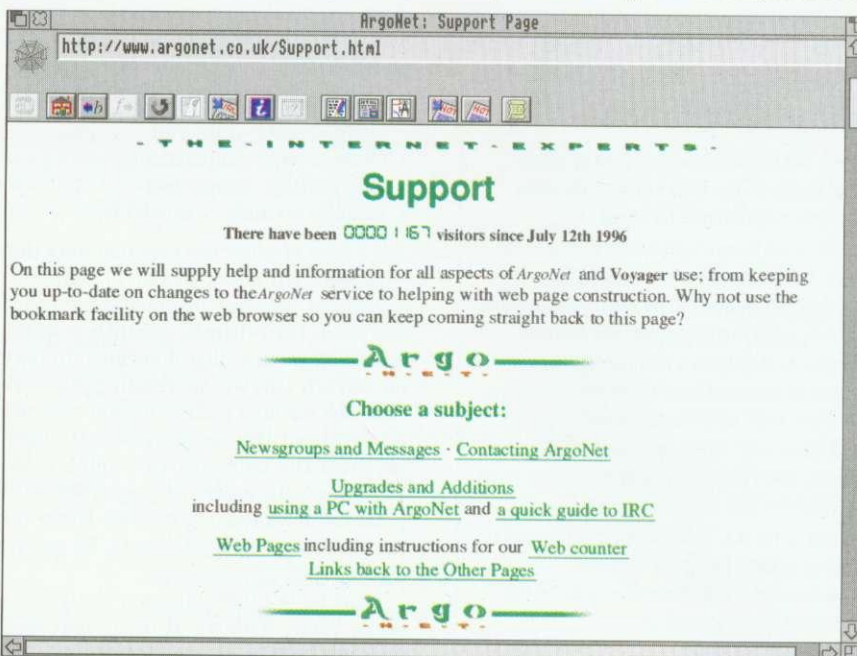

The ArgoNet site makes good use of colour and central alignment of text and images

HTML explained

- `text="#rrggbb"` - text foreground colour.
- `bgcolor="#rrggbb"` - background colour, and the colour that the text will anti-alias to, if you're lucky enough to be browsing using RISC OS. Again, notice the American spelling - it won't work if you write 'bgcolour'.
- `link="#rrggbb"` - link colour, the colour text in an anchor tag will appear (see August for anchor tags).
- `vlink="#rrggbb"` - visited link colour, the colour that a link will be if it's a link to a page that you've already visited.
- `alink="#rrggbb"` - 'active' link colour. A link may flash this colour when clicked upon, although a few browsers also consider links to named tokens within the same page to be 'active'.

The reason that you should set all of these is that it is perfectly possible for someone's browser to be configured by default to show white text on a black background, or indeed any combination of colours that the person using the browser happens to like.

If you impose a background image on them, then you should also suggest a combination of colours that goes well with that image. I came across one page where the background was a blue fractal pattern, but where the designer had forgotten to change the link colour, so that on most default browser settings the links were invisible. Not helpful.

The font tag

As well as setting colours globally, you can set them locally with the ``/`` tag pair. This non-standard tag takes a number of possible attributes, one of which is **color**, specified in the same way as above. Therefore:

```
This is some <font color="#0000ff">
blue</font> text
```

Setting the standards

When I write of 'standard' HTML, I am in fact referring to the HTML 2.0 standard published by the World Wide Web Consortium (W3C) in late 1994. This is a convenient reference point, as most browsers support at least this standard (even text-only browsers support it as best they can). We've covered most of the HTML 2.0 standard in the issues before this one; only forms and some of the header tags have been left out.

There have been many extensions to this standard, with new tags being added by a number of parties. The most significant (and most of the ones mentioned in this issue) were added by Netscape Communications Corporation for its browser *Navigator*. Since *Netscape Navigator* has been for some time the most popular browser on the Web, it has

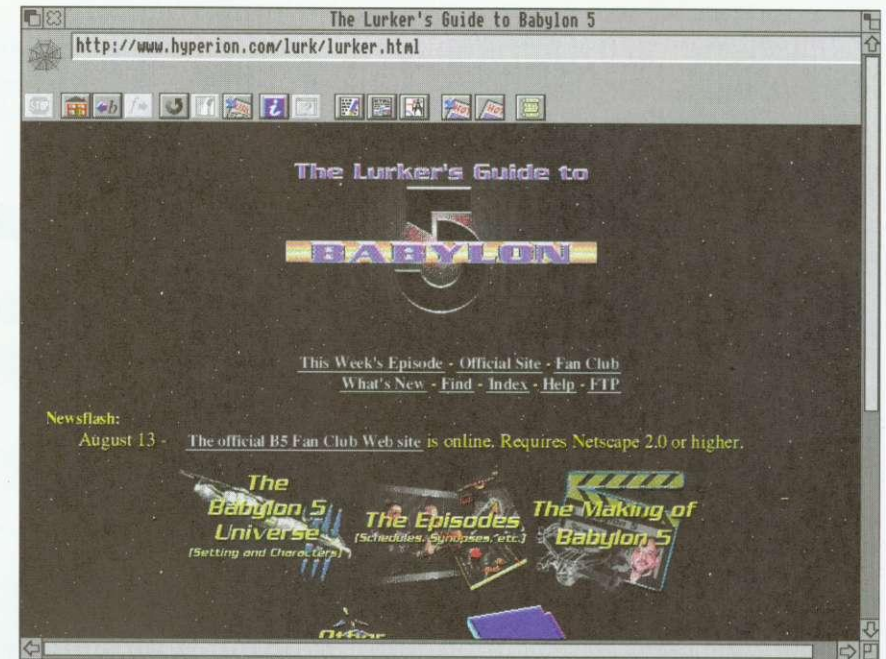

A gratuitous Babylon 5 screenshot, illustrating a tiled background and very non-standard colouring

will colour the word 'blue' blue (at least on browsers that understand this tag).

The `` tag can do more than change colour - it can also be used to change the size of the display font as well. This uses the **size** attribute to specify either a particular font size, or a change in size from the current font. Therefore, you can have either:

```
<font size=6>This is some large
text</font>
```

or

```
<font size=+2>This is two sizes
larger than before</font>
```

Font sizes are in arbitrary units on a scale of one to seven - it's up to the

browser to map these to actual point sizes. The base font size on most browsers is three, so one and two are smaller fonts than normal, and four to seven are larger than normal.

I have rarely, if ever, seen changes in font size used well. After all, it's not a very common practice in standard typography for a good reason - it tends to look messy. If you decide your pages lack the extreme avant-garde look then by all means use it, but you didn't hear it from me, OK?

Other tags

There are a few other tags and extensions to tags in reasonably common usage that extend the HTML standard. Last issue I introduced the bold and italic tags - there are also:

- `<u>`/`</u>` - underlined text
- `_{`/`}` - subscript
- `^{`/`}` - superscript
- `<big>`/`</big>` - larger text
- `<small>`/`</small>` - smaller text

and a host of other less common ones that I haven't got room to list ... with one exception. Netscape invented a tag called the blink tag (`<blink>`/`</blink>`) which caused all the text that it enclosed to flash on and off. This was so irritating that even Netscape relented eventually and now disapproves of the tag (besides, it's now invented the animated GIF which is the blink tag with orders of magnitude more potential for annoying people). Never use the blink tag; you'll get flamed. By me, for a start.

Next issue I'll be taking a short break while Stuart Halliday of the Cybervillage describes how to get the best from your images.

A3000 upgrades

Memory

1-4Mb	£85 (99.87)
1-2Mb	£39 (45.82)
(See also the "2nd user" section)	
1-2Mb (upgradable to 4Mb)	£54 (63.45)
2-4Mb upgrade pack	£45 (52.87)
4-8Mb	£175 (205.62)

The above upgrades are all constructed on four-layer boards, as recommended by Acorn. Gold plated connectors are used for reliable contact with the A3000 main board. There are no clips or wires, and no soldering is required (except 8Mb). Full instructions supplied. Some older types of 2Mb board cannot be upgraded to 4Mb, but we offer a trade-in allowance. Please phone for details.

Hard drives

A range of internal hard disc upgrades is available. The upgrades simply plug into the internal expansion slot. Also suitable for the A3010.

120Mb	£135 (158.62)
170Mb	£145 (170.37)
240Mb	£169 (198.57)
RISC OS 3	
ARM3 (25MHz)	£39 (45.82)
	£129 (151.57)
(Dealer fitting recommended for the ARM3)	

A3000 4Mb RAM £85 (99.87)

RISC PC 16Mb SIMM £69 (81.07)

A5000

Memory

2-4Mb	£69 (81.07)
4-8Mb	£175 (205.62)
Dealer fitting for the 8Mb upgrade is recommended for the 25MHz A5000.	

A3020/A4000

Memory

2-4Mb	£74 (86.95)
Hard drives	
120Mb	£75 (88.12)
170Mb	£89 (104.57)

A400/1

Memory

Per Mb (up to 4Mb)	£30 (35.25)
4-8Mb	£175 (205.62)
RISC OS 3	£39 (45.82)
ARM3 (25MHz)	£129 (151.57)

Hard drives. For prices, refer to the A310 section.

Various

Alsystems SCSI 2	£170 (199.75)
ARM3	£129 (151.57)
RISC OS 3	£39 (45.82)
MEMC1a	£39 (45.82)
MEMC1a (2nd User)	£20 (23.50)
Hard disc cradle	£6 (7.05)
Fan filters (pack of 5)	£3 (3.52)
RISC OS manuals, no vat	£22
Dongle dangle	£6 (7.05)
Chip extractor tool	£4 (4.70)
(for eg MEMC, ARM2)	
CDFS upgrade for Oak SCSI card	£25 (29.37)
The following item is reduced to clear. Please phone to check availability.	
Wordworks	£23 (27.02)

How to order: The VAT inclusive amount is shown in brackets. Cheques made payable to IFEL. Most Credit cards accepted, and Switch. Official orders welcome.

Educational and quantity discount available. Dealer enquiries welcome.

IFEL

21, Glenfield Road, Glenholt, Plymouth PL6 7LL. Tel (01752) 777106. Fax (01752) 777830

A3010 upgrades

Memory

1-4Mb	£89 (104.57)
1-2Mb	£38 (44.65)
2-4Mb	£75 (88.12)

The 4Mb upgrade is constructed on a compact four-layer board. No soldering is required. Full instructions supplied.

Hard drives

A range of internal hard disc upgrades is available. The upgrades simply plug into the internal expansion slot. For prices, refer to the A3000 section.

RISC PC

SIMMs...

4Mb	£20 (23.50)
8Mb	£39 (45.82)
16Mb	£69 (81.07)
32Mb	£139 (163.32)

**16Mb SIMM to 32Mb upgrade
£82 (96.35)**

(By upgrading your 16Mb SIMM to 32Mb you don't lose a SIMM socket. The original 16Mb SIMM must be returned to IFEL and the type must be suitable - most are. Please phone to check first or ask for our free leaflet.)

RAM packs for upgradable SIMMs

4Mb-8Mb	£29 (34.07)
16Mb-32Mb	£77.50 (91.06)

Each pack consists of 8 chips which simply plug into empty sockets. Instructions supplied, no soldering needed.

VRAM modules...

1Mb	£59 (69.32)
2Mb	£99 (116.32)
1Mb-2Mb upgrade	£65 (76.37)

A310

Memory

2Mb	£59 (69.32)
4Mb	£89 (104.57)

Backplane (4-slot, four-layer)

	£49 (57.57)
Fan for above	£8 (9.40)
RISC OS 3	£39 (45.82)
RISC OS carrier board	£17 (19.97)
ARM3 25MHz	£129 (151.57)
MEMC1a	£39 (45.82)

Hard drives

850Mb IDE	£125 (146.87)
1Gb IDE	£135 (158.62)
IDE controller	£65 (76.37)
SCSI discs also available.	

2nd User

Please phone to check availability.

A3000 1-2Mb	£20 (23.50)
A3000 RAM board	£5 (5.87)
(ie bare board, no chips)	
A5000 2-4Mb	£38 (44.65)

Spares/Repairs

We carry stocks of most replacement chips for the Acorn range. (MEMC, VIDC, IOC and most memory devices). We can also fit any upgrades and offer a computer repair service.

All products (except some marked "2nd User") are fully guaranteed for 12 months. All items normally carried in stock have a 14-day money-back guarantee. Please note that the cost of memory products varies - please phone for the latest pricing.



A meeting of the minds

During the last couple of years, two companies in particular have been responsible for producing some excellent datafiles for most areas of the curriculum. Between them, Anglia and Longman have a huge catalogue of datafiles, many of which contain so much support material that they could be regarded as 'off-the-shelf' teaching modules. The problem is that if you want to use them, you need to use the appropriate proprietary database program.

Unless you have enough capitation to buy both, whichever database program you choose will deny access to the datafiles of the other. (Longman's *Pinpoint* files won't run with Anglia's *KeyPlus* and vice versa). If, like me, you use another database you won't have access to any of the datafiles which really is a shame. (Unless you can afford all three in which case that really will confuse everyone.)

Call me biased, but for me, Iota's *Datapower* is the database for Acorn computers. Apparently, (and I didn't know this until

recently) *KeyPlus* files have limited compatibility with *Datapower* in so far as *Datapower* will read the text from a *KeyPlus* datafile and create a *Datapower* datafile. There will be no graphics and the layout will be rather basic, but it does work.

Anglia have been talking to Iota and have created improved compatibility between *Datapower* and *KeyPlus* files so that graphics will be imported. In addition to the developments made to *Datapower* itself, Iota and Anglia are working together to ensure that files load into *Datapower's* display appropriately. Anglia will gradually be upgrading their datafiles to include a layout module which *Datapower* will automatically recognise.

Even without automatic layout, this I believe, is a very significant advance in data compatibility. Are you listening, Longman?

Anglia: (01603) 615151.

Iota: (01223) 566789.

Longman: (01223) 425558.

Aerial photos

Geography departments will be interested in some new products and a new service from Photoair (who produce the CD-ROM *London from the Air* - reviewed January 1996). PhotoAir now have collections of aerial photographs taken along UK rivers. Most rivers in the UK are covered and each pack contains 10 high quality digitised aerial photographs taken along the river's length.

The 10 pictures include the source and mouth and eight shots along the river showing important features such as islands, meanders etc. An accompanying text file gives location and map reference. Select two UK rivers for £40 the pair.

PhotoAir will also provide aerial photos of your school site and the surrounding area. The *School Locality Pack*, as it's known, costs £64.50 for three photos: the school campus and two nearby locations. (There is heavy emphasis on the word 'nearby' - Dorset schools, for example, may not choose a site in the Midlands)

Although this may seem a little pricey, it costs real money to fly an aeroplane and most of the price is for this. Once the pictures have been taken, you can choose from A4 colour prints, and/or have the pictures digitised. The cost of digitised pictures includes

an unlimited site licence plus the right to use the image in a school brochure and place it on the Internet.

PhotoAir: (01733) 241850 or fax (01733) 242964.

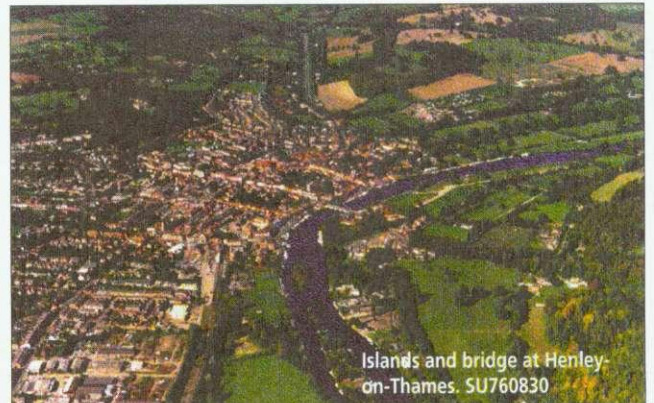

No Hodge Podge for Acorn

"Visit 'Hodge Podge House' with Sherston as they go online with AOL the world's largest and fastest growing Internet provider", says the press release. It continues, "Sherston is launching *Hodge Podge House*, a new interactive experience to be found within the AOL's Kids section. This unique area is full of fun and meaningful activities for children between the age of 5 and 13 years."

Looks good doesn't it. Unfortunately if you use an Acorn computer, you can't access this software. At the time of writing, there are no plans to produce an Acorn compatible version. It's a great shame that Sherston, a company synonymous with Acorn software are involved in a venture that excludes Acorn users. Perhaps someone might reconsider.

Touching a raw nerve

After my comments about the Lindis Touch Screen in the September issue, Resource felt that I had implied Lindis had made a major technological breakthrough in producing a touch screen which is compatible with all existing software. They pointed out that their Touch Windows has been around for some time, as has another by SEMERC, both of which may be regarded as alternatives to the existing mouse.

Contacting me

You can contact the Education page by writing to me, Geoff Preston at Acorn User, IDG Media, Media House, Adlington Park, Macclesfield SK10 4NP or by e-mail to: aueduc@idg.co.uk

HIGH SPEED INTERNET ACCESS

New Dual High Speed Serial Interface Expansion Card

Provides two additional RS232 compatible serial interfaces

Baud rates from 50 to 230400 including 9600, 19200, 38400, 57600 and 115200

Software supplied supports ANT Internet Suite, Terminate, Voyager, Internet Starter Pak, ARCfax, Hearsay II, ARCterm 7, etc

Can be fitted in A310, A440, A410/1, A420/1, A440/1, A540, A5000, A7000 and Risc PC (StrongARM compatible)

Requires RISC OS 3.1 or later

Modem, cable, card and communication software bundles available

Other products include SCSI Interfaces, Discs, CD-ROM's and Tape Drives, IEEE488 Interface Cards, 8 and 16 Bit Parallel I/O Interface Cards, 12 Bit ADC Cards, ARINC429 Interface Cards, STEbus Interface Cards, FORTRAN 77 Compiler, complete computer systems, etc

Contact the Sales Office for further details

Intelligent Interfaces Ltd, P O Box 80, Eastleigh, Hants, SO53 2YX
Tel: 01703 261514 Fax: 01703 267904
Email: andy@intint.demon.co.uk

 **INTELLIGENT
INTERFACES**

Now, 3 times the choice, 3 times the  **Impact**

 **Impact Junior**

£65.00
+ VAT

This new low cost database is aimed at junior school pupils and home users with simple requirements and low budgets. It incorporates all the easy to use features of the current Impact² database, but without the relational facilities.

 **Impact²**

This has now been greatly enhanced, featuring easier to use field selections card design, and exporting facilities.

£95.00
+ VAT

 **Impact Professional**

SEE THEM AT

Stand 50
Olympia
1-3 November

Acorn 
WORLD

This new version includes all the easy to use relational database facilities of Impact², but also features user programmable action buttons. Impact Professional is much more than just a database.

£125.00
+ VAT



Or PHONE, WRITE, or EMAIL for sales or details to -

P.O. Box 36
BODMIN
PL30 4YY 01208 850790

sales@circlesw.demon.co.uk



The easy choice

To make use of the Global Positioning System, you need a GPS receiver. Hand-held, self-contained GPS receivers are about the size of a mobile phone having a small keypad and a LCD screen to show your location. Many, but not all, have a port into which can be connected a computer – presumably a portable computer – where the data can be processed further. However, connecting a Pocket Book to one of these seems like a duplication of hardware (you'll have two screens and two keyboards where only one of each is required).

The hardware

Positioning International Ltd can supply a GPS receiver which has no keyboard or screen, just a cable with a plug on the end. Manufactured by Garmin, it connects either into a specially designed cradle which fits into a car or boat and powered from the cigarette lighter, or directly into the Pocket Book via the A-Link.

The cradle is a very cleverly designed product which securely holds the Pocket Book and automatically taps into the serial port and external power socket. The cradle comes with a variety of hardware in the form of brackets and screws and is designed to be fixed to a suitable place in the car. However, as I had to return the unit to Positioning, I chose to fix it to the dashboard with copious quantities of blu-tack.

The software: FindIt

FindIt is available on either SSD or floppy disc. If purchasing the floppy disc version, you'll probably need to buy a fairly meaty SSD to hold all the files and the main programs, but if you have a serial link and can run *Windows*, this is by far the best option. Transferring from disc to Pocket Book has been made as simple as it's possible to be and you have the option of transferring the files and programs to any

combination of main memory, drive A or drive B.

Once installed, the program is launched in the usual way, by highlighting the icon and pressing enter. If a GPS receiver is not present or there is a weak signal, the software offers a test mode or demo mode. The manual suggests trying the software without the GPS receiver connected so that you may become familiar with the software.

This, I discovered, is a very good idea as the program includes an enormous number of keyboard shortcuts to access the different modes, including a real time compass.

FindIt in use

FindIt is supplied with databases of UK place names, road junctions, fast food outlets and petrol stations. The program, therefore, is most suitable for use in the UK. When you start a journey, enter your destination and *FindIt* will more or less take you there. The display is clear and simple and provides up-to-date info which you can glance at from time to time. If used in this way, you

Finding your way

Continuing from last month's introduction to GPS, Geoff Preston takes a more detailed look at two solutions for touring the country

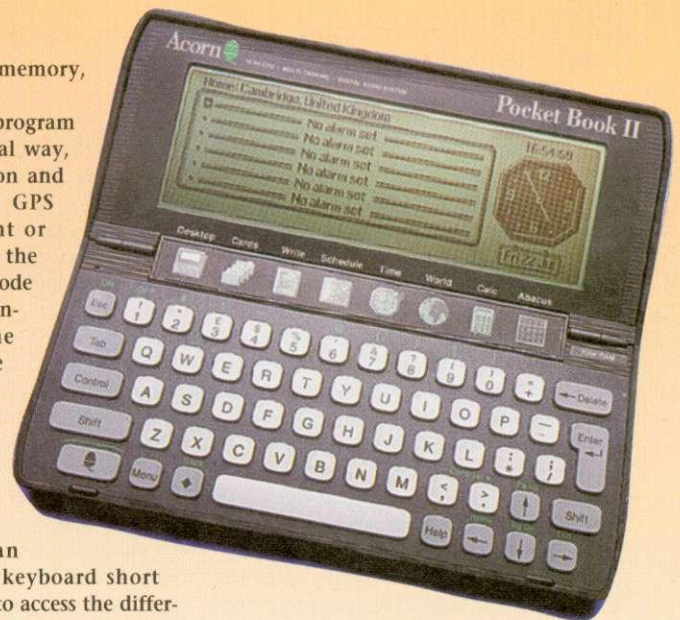

←	Distance:	Speed:	UK Towns	
	52.7 m	57 mph	↑ 0.6	TRING
Positioning	E.T.E: Moving Away		→ 3.1	IVINGHOE
			↙ 4.3	BERKHAMSTED
			↘ 4.9	LEE CLUMP
Display		Destination		
Comp		Prev Next		

Shows current distance from destination and four nearest places from location

↖	Distance:	Speed:	NGR: SN47	
	19.8 m	38 mph	W	
Molenheide	E.T.E: 0 Hr(s), 30 Min(s)		S	
			S	

Useful in Europe, FindIt shows you the way back and displays a compass

just use the display; it shouldn't cause any problems. Don't attempt to use the computer (such as entering place names into the database) while on the move:

As you're driving, the direction arrow constantly changes direction, as do the arrows for the four nearest places, road junctions, fast food outlets or petrol stations, depending on which database you're currently accessing. Along with this information is the estimated journey time remaining and the current speed. The journey time is not very reliable for several reasons, not least of which is the fact that the distance is calculated 'as the crow flies' and consequently less than the actual road distance. I also found the speed was consistently 5 to 7 per cent below the actual road speed which is way outside the

AutoGPS Press ESC to switch to AutoRoute Express		
GPS Receiver		AutoRoute
Getting GPS fixes: Yes		Running: Yes
Lat/Lon WGS84	OS Grid reference	Under Control: Yes
	TL 05760 06520	Cursor Grid Ref.
Mileometer: 0.00 miles		TL 05760 06520

Adds a moving map display to AutoRoute Express

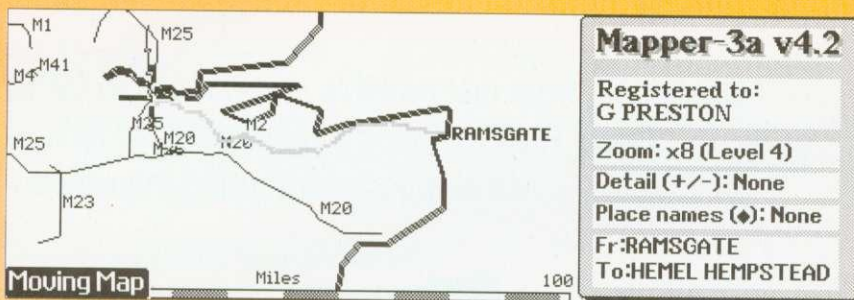

Plotting the path (in grey)

expected inaccuracy from the car's standard speedometer.

Although *FindIt* (or rather the data currently distributed with it) is intended for use in the UK, there is one feature which makes this package suitable for use on the continent. *FindIt* can offer the opportunity to enter the name of the current location and will automatically take the current NGR and add both items to the current database. (NGR is the National Grid Reference which takes the form of XXEEENNN eg TQ175302 which is Horsham.)

Developing that idea, you can enter points along the route and compile a log of the journey which will enable *FindIt* to provide a more accurate route for the return journey. While on holiday in Europe, I entered the name of the camp at which I was staying, and while touring, entered strategic points along the way which enabled me to tour the country at leisure and use *FindIt* to get me back to the camp.

Alternative software: Mapper3a

Once you have a GPS receiver, you can use the latest version of *Mapper3a* to decode the information. *Mapper3a* can be downloaded from Steve Litchfield's 3Lib PD and Shareware library. Remarkably, it is shareware and will cost £14 to register. Apart from the ethical point of view, registering does unlock several features of the software making it slightly more friendly or usable in certain areas.

Mapper has been covered in *Acorn User*

before. It's a very powerful geographical information system which has the ability to use GPS data, provided a suitable GPS receiver is connected. I used the same receiver with *Mapper* as was supplied with *FindIt* and in general, it worked very well.

There were a couple of slight glitches, however. The first is that it seems to need a much stronger GPS signal than *FindIt*. The second hiccup was when returning home - the system stopped working while travelling on the M25. Perhaps that says more for the road than the software, but it meant the moving map display had to be 're-engaged' which was not a problem other than it lost the trace. (One of the few options available in the moving map display is the facility to leave a trail showing where you've been.)

Other software

AutoGPS adds a moving map to Psion's *AutoRoute Express*. If you've got *AutoRoute*, this is a worthwhile extension, even if you don't have a GPS receiver as, among other things, it displays the cursor position grid reference on the *AutoRoute* screen. *AutoGPS* is available from 3Lib.

Conclusion

If you get a buzz from people gathering around your car with their mouths open, and then having to answer lots of questions about a gadget they've probably never heard of, let alone seen, this is probably the best piece of kit around.

If you do a lot of touring, *FindIt* is probably a worthwhile investment, although it

will be a better proposition with European data. However, if European data was provided to the same detail as UK data, you'll need a really large SSD or split the data into countries. Unlike *FindIt*, *Mapper3a* really only works on UK mainland as the only GPS data output is the moving map, and at present that is only UK and Ireland.

For use 'on the road' (as opposed to 'at sea'), I wouldn't care to say that GPS is any better than a traditional map for the purpose of touring, largely because of the limited amount of information you can get on a screen and the fact that signposts around the country are really very good. But this is certainly a great deal more fun.

As for the driver using either of these programs in a moving car, it sounds too dangerous to contemplate. I suppose one could argue that they are no more or less distracting than the average in-car sound system. Positioning Ltd claim that their system is totally automatic and just provides information for the driver to read like any of the other instruments in the car. Indeed, the system was designed for sole travellers. Even so, I would still prefer to leave it to the navigator. **AU**

Product details

Product: *Mapper* (£14 to register) and *AutoGPS* (Remember to send a PC formatted disc, return postage and £1.50 handling)

Supplier: 3-Lib

Address: 22 Grays Crescent, Woodley, Berkshire, RG5 3EN

Tel: (01734) 265081

Mapper can be downloaded from <http://ourworld.compuserve.com/homepages/slitchfield/gpsnotes.htm>

Product: *FindIt* costs £99 + VAT on disc, the GPS receiver used cost £199 + VAT and the In Car Cradle cost £120 + VAT with serial link or £99 + VAT without

Supplier: Positioning International Ltd

Address: 54 Queen Street, Horsham, West Sussex, RH13 5AD

Tel: (01403) 276811

SsS = ?

The answer....

Sibelius Software SPECIALISTS!

The best music processing software in the world, bar none! And the best place for a demonstration?

DON'T DEAL IN THE DARK! COME AND SEE THE LIGHT AT

THE DATA STORE

6 CHATTERTON ROAD, BROMLEY, KENT, BR2 9QN

Tel: 0181-460 8991 Fax: 0181-313 0400

Email: sales@datstore.demon.co.uk

If you're fed up with warehouse stores that don't know anything about what they sell, or shops that let you look but not touch, try us for a change! Come in and take advantage of our expertise and considered advice before you buy, and after you've made your purchase, we won't leave you in the lurch if you hit problems - our service is renowned around the world!

ACORN CENTRE OF TECHNOLOGY

P.S. If you want a full demonstration of Sibelius, ring us first for an appointment - you'll need to reserve at least an hour!

Part Exchange to RisePC

Risc PC600	£ 1105.00
Risc PC700 5M	£ 1318.00
Risc PC700 10M	£ 1531.00
Eight speed CDROM add	£ 85.00
17" Monitor add	£ 300.00
StrongArm upgrade for £99.00 available with all new RisePCs until December 31st	

SIMMs for RisePC

additional 8Mb	- £40.00
additional 16Mb	- £75.00
additional 32Mb	- £145.00
trade-in allowances:	
4Mb	- £15.00
8Mb	- £25.00
16Mb	- £45.00

Typical Trade in Allowances

A310	£ 125
A3000	£ 125
A440/1	£ 200
A4000	£ 250
A5000	£ 400

Acorns 0% Finance Scheme available on exchanges



A7000 Special Package

- 4Mb RAM
- 540Mb Hard drive
- Eight Speed CDROM
- Microvitec SVGA Monitor

£845.00

Eight Speed CDROMs for A7000 and PC700

£85.00

AJS Computers

Millstone House
51 Heath Drive
Chelmsford Essex CM2 9HE
tel 01245 345263
fax 01245 345233
email sales@ajscomps.demon.co.uk
all prices plus vat and carriage

Hard Disk Exchanges

For A5000 and A4000
40 or 80Mb to 210 Mb - £ 79.00
40 or 80Mb to 540 Mb - £ 119.00
for RiscPC600
210Mb to 540Mb - £ 99.00
for RiscPC700
425 or 540Mb to 850Mb - £ 79.00
425 or 540Mb to 16Gb - £169.00
850 to 16Gb - £129.00
Software transferred free.

Second Hand

Acorn A4000 4Mb/210Mb
+ AKF50 Multiscan monitor
£ 475.00

Second Hand Equipment

A3000 - £125.00
Master 128 - £35.00
Canon BJC600 - £175.00

easy Font

PROFESSIONAL

Packed with a dazzling array of features, many never before seen on the Acorn platform.

F

AutoFont

Automatic recognition of fonts in files - no need for file scanning

F

Flexible Display

Our powerful and innovative WYSIWYG display lets you see everything you need to

F

Drag 'n' Drop

Drag a font to an application to change highlighted text to that font

F

Grouping

With our fast, effective grouping system finding the right font for a job is easy

F

Space Saving

By storing fonts in a clever way you save on disc space whilst retaining fast access

F

Remote Access

Fonts can be left on other drives including CDs, Syquests, Opticals, Floppies etc

F

Create Styles

At the click of a button you can give old fonts new life, add an oblique or an extended or even define your own styles

F

Easy Setup

We've made setting up EasyFont Professional quick and easy, you can simply let it scan your drive and set itself up

F

Export

Save out lists of fonts as drawfiles to create a hard copy of your font collection

F

Smart Buttons

User definable button bar

With the high numbers of low cost fonts available these days it's so easy to run into problems managing them all.

EasyFont Professional is the ultimate tool giving you the control and flexibility you need to get the most from your font collection.

And as the title suggests, it's so easy to use.

RRP £59.95

Special launch price at Acorn World

(see stand 132)

EasyFont3 users can upgrade for a limited period at a special price of just £15 and the return of your original EasyFont3 disc.

Bring your disc to Acorn World '96



Fabis Computing

E & OE

Comparisons

contrasts

The *Exploring a Contrasting UK Locality: Glasson* software package was devised to meet the need to integrate IT into Geography teaching and learning in the primary classroom. The Geography National Curriculum Orders state that children in Key Stages 1 and 2 should be taught to use IT to 'gain access to additional information sources and to assist in handling, classifying and presenting evidence'.

Why Glasson Dock?

Glasson is a village and small port on the Lancashire coast. A combination of geographical features make it ideal as a contrasting location. Although it is a small community, it has an industrial base, a range of transport features and it has adapted to many changes over time. Overall, because of its rich mix of settlement functions, Glasson can be contrasted with many other UK localities.

I decided to assemble a package on Glasson which enabled children to acquire and process information using IT. I would use authoring software alongside datafiles with information about local children and their lifestyles. The latter would be meaningful and also a vehicle for developing information-handling skills. I wanted the package to be professional in appearance, but simple enough to inspire children to produce something similar about their own locality.

Choosing the software

I decided to use *Genesis II* as the authoring software because of its potential to produce an attractive package in very little disc space, making it usable on all Acorn machines. I was very conscious that, although many schools use Acorn systems, most do not have state-of-the-art machines - in fact, the A3000 is a familiar sight in many of the classrooms I visit.

The insertion of photographs of the locality into *Genesis* was achieved by the use of Photo CD. I visited Glasson and took photographs of the key geographical features, including the Dock and the canal basin. I was lucky in that a ship was being

unloaded and so I was able to take photographs of its cargo on the quayside and the mobile crane that is part of the port's facilities. The film was processed and a week later I had the Photo CD ready for use.

Having experimented with presentation software before, I was aware that the application needed to have a simple and uncluttered interface if it was to be successful. I chose a white background and included no more than two photographs or text frames on each *Genesis* page - 'frame' is the program's jargon for the rectangular boxes, containing text or graphics, that can be created on each page by clicking and dragging the mouse's left button.

Navigating and linking

I decided on two methods of navigation through the package - the user could either go to relevant pages by clicking on the labels on a sketch map of the village or could move from page to page by double-clicking on right and left pointing arrows.

Making links from page to page was relatively easy as *Genesis* allows links to be made from any frame on any page. When the mouse pointer is over a frame, pressing the middle menu button on the mouse produces a menu with 'Link to' as an option. Sliding off this option reveals a set of possible linking actions which can be dragged and dropped on to the linked page.

I used *PhotoView* to process the Photo

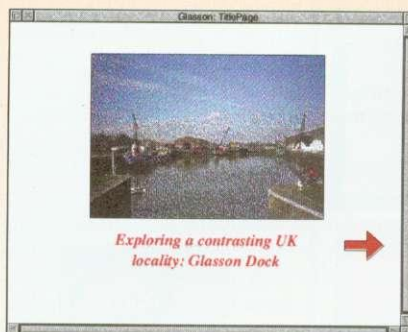

The Glasson application title page

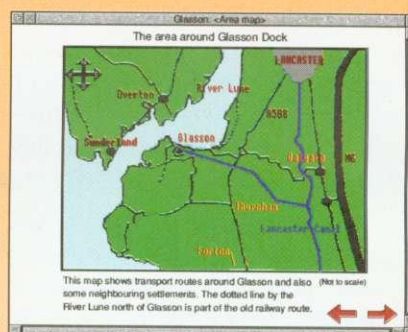

A Paint file map of Glasson in a Genesis frame

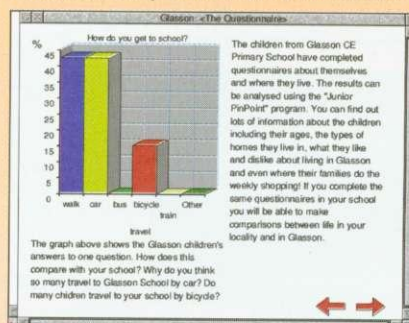

A link to the datafiles

CD images at a quarter of the base size and then transferred them to the frames I had created on the *Genesis* pages. Some image quality was lost, but I was able to squeeze over 20 colour photographs into the application! To save time I typed my text into *Edit* and then dragged and dropped the text into frames on each page. The finishing touches were added using *Draw* and *Paint* files.

The most laborious part of the process was the establishing of links between the sketch map and the relevant information pages. Frames with red text were created over parts of the map and then links to information pages added by the process described above. By the time the page was finished it contained 16 links and was placing severe strain on the memory of my A3020.

Needless to say, the machine crashed at this point and I was forced to re-create the page again almost from scratch. In the completed application, the village map

textease

Simply the Best
Word Processor and
Desktop Publisher

Just click anywhere
and start to type

NEW Windows Version

This award winning software is now available in Windows format. Standard and Talking versions available. Fully compatible with Acorn format files.

NEW Multimedia Version

The Acorn version now allows you to add video, animation and sound. Whether for fun, for learning or for communication, it will bring your documents to life.

Price includes
Primary Site Licence for education customers
Secondary Site £99 + VAT and £130 + VAT

Softase Limited, Tel 01332 204911
The Old Courthouse,
St Peters Church Yard,
Derby, DE1 1NN

For Windows 3.11 and '95 or Acorn RISC OS3.1

Standard
£49 + VAT (£57.58)

Talking
£65 + VAT (£76.38)

Produced on textease

THE

ARM CLUB

The ARM Club

Dept. AUM

FREEPOST ND6573

London

N12 0BR

Email info@armclub.org.uk

http://www.armclub.org.uk/

See us at Acorn World '96, 1st-3rd November

The ARM Club will be fronting the Club area on Stand 386, just at the top of the stairs. Come along and meet representatives from a number of local groups as well as The ARM Club.

The Show will also see the launch of the latest addition to the Club's product range - a must for all those buying a StrongARM card. StrongGuard! will enable a number of games and desktop applications to run on a StrongARM that would otherwise not.

ONLY £25.00
FULLY INCLUSIVE
Upgrades from Game On!
available

Quality in affordable software!

Please make cheques payable to "The ARM Club". For more details, write or send £2.00 for a comprehensive information pack including sample magazine and disc.

Affiliated to The British Association of Computer Clubs

Archimedes Public Domain Library



Public Domain, Shareware and other low cost software for Acorn computers

APDL PD CD-1 now only £14.95

APDL PD CD-2 now only £14.95

A huge collection of P.D. and Shareware at a realistic price.

Buy both PD CDs for just £27.50

APDL Clip Art CD-1 now only £19.95

APDL Clip Art CD-2 now only £19.95

Each contains around 500Mb, all in Acorn format (Sprite, Drawfile and Artworks). Ideal for schools.

Buy both Clip Art CDs for just £37.50

Hard discs

Low cost IDE and SCSI drives and interfaces for all models

A310/A400 IDE

210Mb - £149, 512Mb - £199, 850Mb - £219, 1Gb - £235, 1.6Gb - £265

A3010/A3000 IDE

80Mb - £135, 170Mb - £165, 340Mb - £209, 512Mb - £239, 810Mb - £329

A310/A400/A5000/Risc PC SCSI

Drives: 540Mb - £149, 1Gb - £239, Complete: 540Mb £259, 1Gb - £349

Prices include cables, brackets and fittings. Lots of others available.

Syquest 135 & 270Mb removable, SCSI or IDE, internal or external
Solve your backup and security problems - from £99, discs from £17

Plus

Risc PC RAM upgrades, the famous APDL part-exchange scheme if you need a bigger hard disc (eg. 210Mb to 512Mb for only £115) and more!

For a catalogue please send 50p or two 1st class stamps to
APDL, 39 Knighton Park Road, Sydenham, London SE26 5RN

Phone: 0181 778 2659 Fax: 0181 488 0487



All prices include VAT and carriage



ACORN USER

ADVERTISERS INDEX

1st Computer Centre.....	59	H.S. Software.....	93
4 Mation.....	93	I.C.S. (Ian Copestake Ltd).....	6, 7
4th Dimension.....	85	IFEL.....	53
5 Star Marketing.....	93	Intelligent Interfaces.....	74
AJS Computers Ltd.....	77	Irlam Instruments.....	8
Akalat Publishing.....	88	ISV Products.....	66
Alsystems.....	12, 38, 39, 53	Kimberley Computer Ser.....	64, 65
Anglia Media TV.....	31	Kudlian Soft.....	93
Ant.....	0BC	Liquid Silicon.....	54
APDL.....	80	Mauden Sales.....	95
Apricote Studios.....	45	Minerva.....	68
Armtech UK.....	95	Modus Software.....	95
Beebug.....	11, 33, 87	Pineapple Software.....	IBC
C.J.E. Micros.....	48	Print Maker.....	95
C.S.S.....	98	Quantum Software.....	95
Calancraft.....	98	Resource.....	72
Care Electronics.....	87	Selective Computer Serv.....	93
Colton Software.....	20	Sherston Software.....	17
Castle Technology.....	15	Sibelius S/ware.....	23
Circle Software.....	74	Simtec Electronics.....	42
Computer Concepts.....	IFC, 3	Snap Computer Supplies.....	87
Cumana.....	26	Soft Rock Software.....	95
Curriculum Training Ass.....	72	Softcentre.....	95
Daco Systems.....	98	Softase.....	80
Dalriada Data.....	54	Spacetech.....	56
Davyn Computer Services.....	28, 98	Technology Matrix.....	68
Desktop Projects.....	18	The Arm Club.....	80
Dixon & Dixon.....	95	The Datastore.....	77
Doggysoft.....	88	The Really Good S/W Co.....	66
DSL Supplies.....	95	Topologika.....	93
Eesox.....	88	Tower Electronics Ltd.....	93
Electronic Font Foundary.....	87	Uniqueway.....	98
Explan UK Ltd.....	88	V.T.I.....	24
Fabis Computing.....	77	Xavier Educational.....	95
Generation Design.....	95	Yellowstone.....	56

GAME SHOW

A gauntlet has been thrown down to any Acorn games programmers stalwart enough to attempt the challenge. Shaun Hollingworth of Krisalis Software has announced to the Internet at large that the company is willing to allow the release of *Soccer Kid* as a shareware title – providing an individual or a team of programmers steps forward and offers to code it. Shaun explains that Krisalis is performing this gesture as a sign of good will in return for the support that the Acorn community has given in the

past. This is an excellent opportunity for any budding coders out there to get into the scene – the source code is available for both the Amiga and 3DO versions of the game, and perhaps most attractive of all for first-time programmers, you don't have to think of a storyline.

For those who haven't seen the game before, it revolves around a youth with exceptional ball control as he attempts to rescue shards of the World Cup trophy.

What makes this platform game that bit different is the fact that Soccer Kid can use his

football to great effect – either in disposing of enemies or as a useful trampoline to reach higher levels. I was immediately attracted to its gameplay the first time I played, so the thought that it might be released for the Acorn platform comes as something of a dream come true.

The details are a little sketchy as I write, so if you're interested (and I urge you all to think about this seriously) drop me a line or write to Shaun directly at shaun@moatlane.demon.co.uk. A lot of people have been bemoaning the lack of activity in the Acorn games market; here's your chance to help turn things around – even if you don't know your registers from your SWIs, please give your support to this venture and let us know what you think.

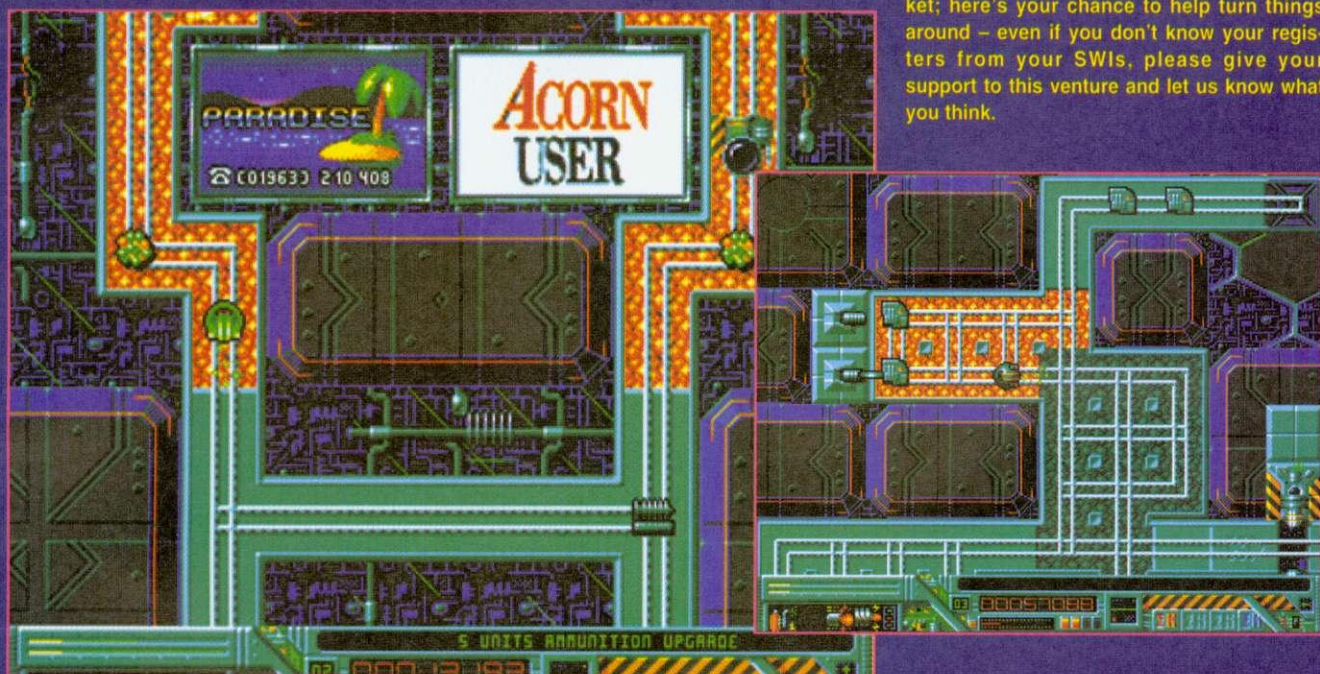

Highly flammable

I'm happy to announce that Paradise has done its bit to relieve the somewhat persistent games drought that's been afflicting the Acorn world for the past few months. With the release of *Inferno*, the team has launched its own budget software range, and I hope it will be adding more games in the near future.

Paradise can be contacted at 12 Kings Close, Longburton, Nr. Sherborne, Dorset, DT9 5PW. They're wired up to the Internet, and you can drop a line by e-mail at info@paradise1.com or pulink.co.uk. *Inferno* costs £9.99, and cheques should be made payable to David Flynn.

As hard as a fluffy thing

Several months ago, I mentioned a game-in-progress by Mike Goatly, beguilingly named *Rock Hard Fluffy Thing*. Best described

as an arcade-style puzzle game, *RHFT* follows the exploits of something akin to a furball on legs as he, she or it races round tortuous routes to collect diamonds. There are many traps to trick the unwary, such as slippery ice sheets and electrified tiles, and 35 levels to enjoy.

The game's finally complete, and it's available for £7 from Mike Goatly at 20 Ely Road, St. Albans, Herts, AL1 5NA – cheques should be made payable to M. Goatly. I hope to review the full game soon, but if you've got Internet access, you may want to wander over to the Acorn games section of ftp.uni-stuttgart.de, as Mike's told me he's uploading a demo there.

Cheats occasionally prosper

Richard Chiswell of Beebware has written to me to announce his latest games-related utility – a cheat database boasting '142

cheats for a wide range of Acorn games'. Requiring RISC OS 3 or above to function, Richard's program sits on the icon bar and gives access to a range of information snippets accessible at the click of an icon.

The range covered is sizeable, including some popular PD titles and a few Infocom adventures – quite a brew of different styles. The content of the tips varies, but generally speaking you'll get a list of passwords for a game, some hints to improve your gameplay or even a cheat mode or two. The material is all very useful, barring the odd spelling error here and there. You might find you recognise some of it; I couldn't say for certain, but a few of the tips seem particularly familiar – perhaps they originated in the pages of one of the Acorn magazines?

The utility also provides a few other functions, including a screensaver, a clock and an

hourly time signal. It's a bit of a mystery why these have been included, for although they might be useful they certainly wouldn't entice me to spend any extra money on the product; there's a lot of good-quality public domain software out there that give this functionality and more.

If you're desperate for a cheat compendium, *Acorn Cheat* might be worth a look – however, it's rather expensive for what it is, especially if you can download one of the Acorn games pages on the Web or you've got stacks of back issues lying around. It costs £7.50 for a single user copy and Beebware, its supplier, can be contacted at 83 Forest Road, Huncote, Leicester, LE9 3BH.

Coming soon

I'm afraid I've no idea what Andrew Docking is going to call the title he's currently working on, so *Futuristic 3D Racing Game* will have to do for now. I

New games

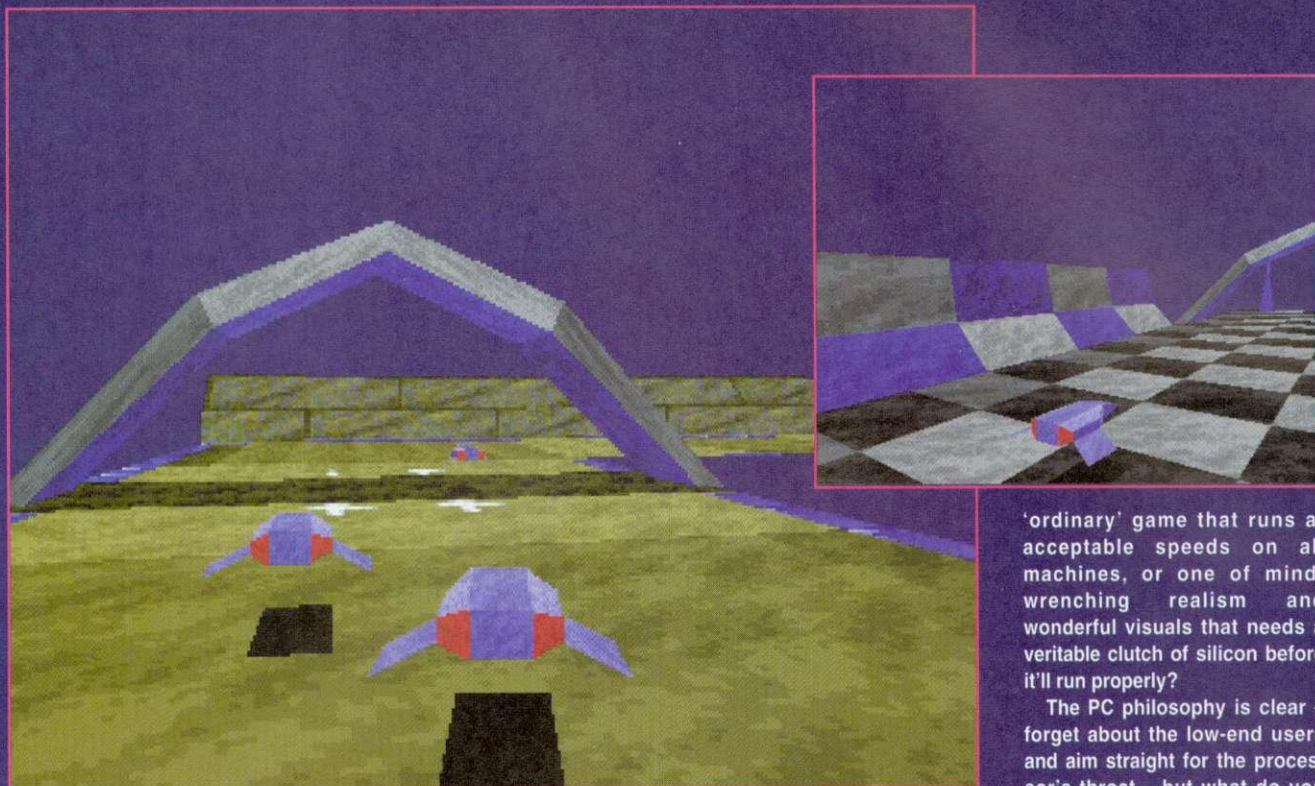

don't think I need to expand on the product's theme – which is fortuitous, as at this stage I know very little concerning the game's plot. However, Andrew's briefed me more fully on the technical nature of the game – texture mapping will be used throughout, although slower machines will be catered for with a *detail* option. The screenshots shown here are from an early stage in the development, and Andrew promises that the graphics will be much improved on in the final version.

With five craft to choose from, each with its own handling style, Andrew's game will allow you to scream round a wide array of tracks in tournament and practice modes, time trials or chase modes. He's currently working on an artificial intelligence routine to give the computer players a little more life, either making them nervous if you drive on their tail, or imbuing them with the silicon equivalent of road rage. I'll keep you posted with any developments.

I've just got time to mention a new strategy game in development by Chris Davis. Named *Age of War*, it's already visually impressive and the brief flick through the prototype manual leads me to believe that if it reaches completion, it'll be a most absorbing product indeed. I hope to receive some more information in the near future – if you've got any particular fea-

tures that you'd want to see in the ideal strategy game, why not write in and I'll pass your suggestions on.

And finally

Let's have a quick straw poll. Rob Templeman was last spotted mulling over an idea to convert the engine of his game *Destiny* so that it would run on multiple processors on the Hydra. It goes without saying

that this would affect the launch date, and it might even alter the gameplay too. After all, with oodles of processing power available, how many cuts to the game would be necessary before it would be playable on a low-end machine? Then again, I must admit that such a game running at full pelt on an Acorn dream machine causes me to salivate.

What would you prefer? An

'ordinary' game that runs at acceptable speeds on all machines, or one of mind-wrenching realism and wonderful visuals that needs a veritable clutch of silicon before it'll run properly?

The PC philosophy is clear – forget about the low-end users and aim straight for the processor's throat – but what do you think? Drop me a line at Game Show, *Acorn User*, IDG Media, Media House, Adlington Park, Macclesfield SK10 4NP or augames@idg.co.uk and let me know.

That's all space will allow for this month, but please join us again next time for more details of Shaun's *Soccer Kid* offer and updates on the progress of all of the major games-to-be. See you then.



Meet Hugo and GTAC

As our competition revealed, plenty of people write adventure games 'by hand', using no special language or tool. The Internet adventure community (see the newsgroup 'rec.arts.int-fiction') are pretty unanimous that one needs a design system though, and the question 'which system is best?', sparks off regular and infinitely tedious wars of invective.

Actually the options boil down to one: use the Brand X compiler to turn an X-file into some kind of program for an imaginary X-machine, and then use an X-interpreter to play this game program on any computer of your choice.

The idea goes back to 1979, when a group of students left MIT and founded Infocom. They wanted to move their famous mainframe game *Zork* to micro-computers. But it took a whole megabyte to run, at a time when a 16K Tandy was a mean machine by home standards. And until the late '80s, there were never less than a dozen home computer models in use, housing four or five different microprocessors: 6502, Z80, 68000 and so on. The individual markets were small and the challenge was to find a product to sell to all of them.

So Joel Berez and Marc Blank designed the 'Z-machine', a virtual computer using virtual memory. (In this they were far ahead of their time - 17 years later and the Java bytecode machine may soon be in every phone and television set.) Infocom then wrote 'interpreters' enabling individual computers to pretend to be Z-machines, and so to play the Z-code games. (Kevin Bracey's Zip2000 turns RISC OS into the Z-machine even today.)

Graham Nelson reviews two designs for design

The new Brand X?

From Advsys to ZIL, adventure design languages are legion, though they vary widely in quality. Brand X, whichever is the current favourite, comes and goes; Brand Z, alas, is long gone, in that Infocom's own design language ZIL ('Zork Implementation Language') no longer exists. Infocom compiles a language of its own to the Z-machine, but Infocom's compiler ZILCH is missing, believed deleted.

Up to about 1994, the popular choice was *TADS* ('Text Adventure Design System'), a ground-breaking compiler by Mike Roberts; since then, *Inform* seems to have taken the lead, so to speak, and *Hugo* is tipped by some to be next. *Inform* was so called because it forms Infocom files (sorry), but why 'Hugo', I've no idea. 'Hugo was a madman who believed he was Hugo,' as Cocteau put it, and that will have to do.

Hugo was begun by Kent Tessman only last year, and it has further to go, but people are starting to use it. It is extremely similar in design and syntax to *Inform*; whereas *TADS* is fairly different, and it may be worth a moment to say why.

Making sense of sense

All adventure languages agree on the basics. The world is modelled by 'objects' which may be places, people or tangible things such as a lantern: each will have

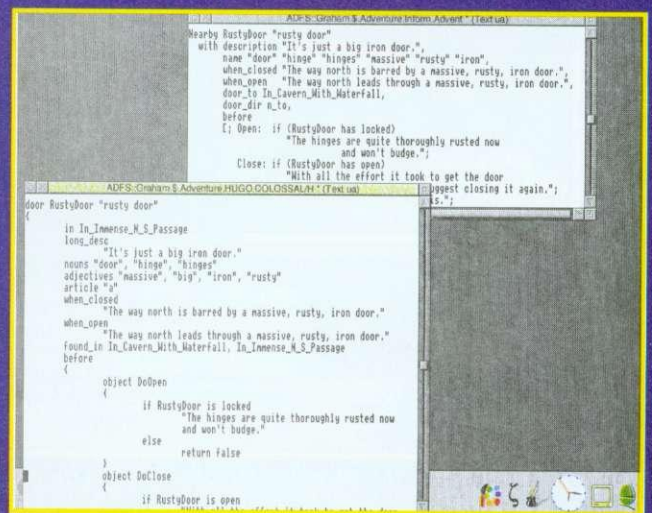

Parallel lines: the same program in Inform (above) and Hugo (below)

some data attached, such as a name and a description, and perhaps some programming as well. The lantern has to respond to being rubbed or being switched off, and it's sensible to keep those parts of the program glued to the lantern's definition.

TADS, *Inform* (and *Hugo*) agree, also, that the best way to specify the world is just to specify the unusual things in it - the exceptions to what would normally happen. Thus, a grenade is much like any other lump of metal, so the game designer should only have to describe what happens when its pin is pulled.

Since unusual things are going to happen, it can be hard for a game to decide whether a player's command is reasonable ('look under the carpet') or insane ('look under the sky'). *TADS* and *Inform* differ on this. Under *TADS*, objects provide routines to 'verify' that verbs are sensible for them (for instance, 'eat' would not be verified by a brass bell, and 'ring' wouldn't by

a banana). This information feeds back into the parser, which uses it to decide what the player intended. If the player typed 'eat bell', while holding a brass bell and a chocolate bell from a Christmas tree, the parser would be able to infer which was intended.

Inform, on the other hand, lets all grammatically correct commands through and relies on the objects themselves to sort out what is sensible, by giving rules that apply 'before' and 'after' what is suggested should happen. It's usually more concise, but maybe less elegant: the more I think about this, the less convinced I am that the right solution has been found.

The Hugo engine and compiler

Hugo has a compiler, for translating game descriptions into games, and an 'engine' for playing them: these are called 'hc' and 'he'. The standard distribution also comes with a concise and cleanly-written manual, and

Adventure games

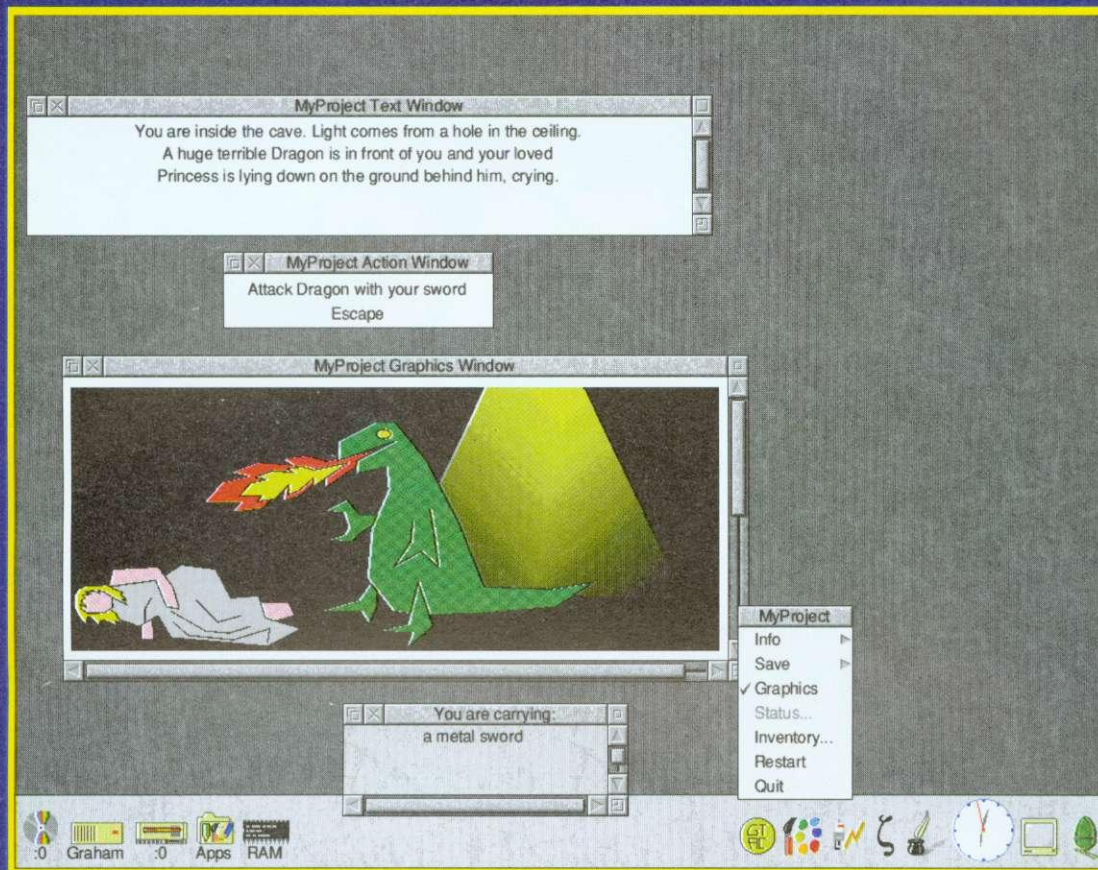

Suzanne Vega, complete with brief sound sample, threatened by silent dragon

two example games: *Colossal*, the obligatory translation of the original mainframe adventure, and a *Sample*.

Hugo's syntax is so very close to *Inform's* that they are almost machine translatable. I see this as a compliment, and Mr Tesson is entirely open about it. It is a smaller and tidier language, which is a good thing, but with defects: C programmers will not be pleased that the '.' operator is right associative, so that 'lilypad.frog.tongue' does not mean 'the tongue of the frog on the lilypad', i.e., '(lilypad.frog).tongue', but is instead meaningless. Likewise, bracing with 'if' and 'for' statements is not quite right, and 'switch' evaluates the quantity being tested more than once, which is questionable. But these are niggling criticisms and will probably be seen to in future.

Hugo is not without innovation: it has an interesting idea of 'events' programmed to happen in various circumstances, and of 'scripts'. Most games have characters who wander around, picking things up and generally

making a nuisance of themselves. If they are to behave mostly predictably, a Hugo 'script' is a neat way to program them.

The compiler 'hc' is in good working order but reports errors erratically or, in a few cases, not at all. On my Risc PC it runs rapidly and without memory trouble; for comparison, *Inform 6* compiles *Advent* in 10 seconds, and *Hugo 2.2* compiles *Colossal* – a direct port of

Product details

Product: Hugo 2.2
 Author: Kent Tesson; RISC OS port by Colin Turnbull
 FTP: ftp.gmd.de, under 'if-archive/programming/hugo'
 Price: Free

Pros: Clean design • Good manual • Full scale language

Cons: Compiler slightly primitive • Perhaps too like *Inform* to be much alternative

Advent – in 39; but both are much faster per source line than (say) Acorn C/C++, and speed will not be a problem in practice.

The *Hugo* 'engine' design has similar limitations and virtues to the Z-machine: no graphics or dramatically lavish text, but good portability across a range of machines. The RISC OS port of 'he' is single-tasking, playing games in a chunky text mode with the system font, but is rapid and works perfectly. It will play, monochrome, in a desktop TaskWindow, but even under *Zap* on a Risc PC this is slow.

For all my reservations, *Hugo* is one of the handful of design systems to seriously address a complex problem: if it can be kept clean and neat as it develops, it'll go far.

And now, GTAC

GTAC (Graphic Text Adventure Creator), by Andrea Gallo, has different ambitions. It's a desktop editor for creating simple point and click games, with just a short menu of options for the player at each point. *GTAC* makes the most of this very lim-

ited idea of 'adventure game' by allowing graphics (Draw files) and sound samples to be added.

Animation and more flexible control over graphics are not available, which is a shame (it would be nice to be able to run short BASIC programs); and it's impossible to ask the player any kind of question which isn't multiple-choice, a pity as *GTAC's* best use might lie in writing educational games.

On the plus side, *GTAC* has variables and a built-in 'combat system' in the style of a role-playing game. The registered version comes with a nicely-typeset 25 page manual, easily readable at a sitting; and the desktop interface is

straightforward. There is one, very small, worked example game; Mr Gallo rightly says it is quick to construct; then again the average player will finish it in about 20 seconds.

'Interactive game books', so called, mazes of numbered paragraphs to read through and make choices between, used to be quite popular. *GTAC* is how you might computerise them, though I rather think the computer is what made them obsolete.

Product details

Product: GTAC
 Author: Andrea Gallo
 Address: 237, Viale Cortina
 d'Ampezzo, 00135 Roma,
 Italy

Telephone: +39 6 35 50 60 14
 Price: £7 (or 15000 lira)

Pros: Simple • Well desktopped
 • Nice manual

Cons: Limited range of possible games

NOT ONE BUT TWO NEW RELEASES FROM THE FOURTH DIMENSION

! Logic Mania

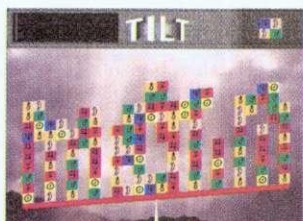
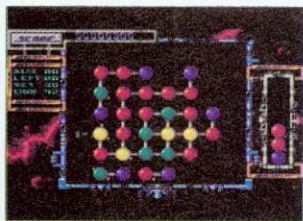

Presenting value for money in the extreme!
FOUR brand new titles in **ONE** package.
Challenging your powers of memory, observation, dexterity, reasoning, logistics and of course, sheer common sense- LOGIC. This compilation takes puzzle solving to new boundaries and stretches the player(s) to the point of frustration.

PACK INCLUDES:

- Atomix.** Calculate molecular construction in this IBM conversion.
- Tilt.** 1 or 2 player mounting block game - on a see-saw!
- Gloop.** Drain-pipe construction against the clock.
- Blindfold.** A game of memory, negotiate the maze - Blindfold!

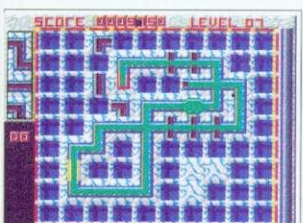

Logic Mania is available from all leading stockists of Acorn games. PRICE £ 34.95

The Real McCoy 5



ANTI GRAV

This is a brand new game on a popular theme, from the latest team of Acorn dedicated programmers. You must guide your craft around dozens of mazes & caverns.

CHOPPER FORCE

Superb 3D graphics, stunning sound effects and riveting game-play combine in this futuristic helicopter simulation. Combat the modern terrorist in style! Previous RRP £ 34.95.



DEMONS LAIR

This is a great game for all the family, yet it will challenge the adventure enthusiast, with lots of tricky but logical puzzles and some great arcade action. Previous RRP £ 25.95.



PANDORAS BOX

Now regarded as a classic, this game has an intriguing blend of puzzles and full blooded arcade action. 200 screens of stunning artwork and quality game-play. Previous RRP £ 25.95.



The Real McCoy Vol 5 is on sale from November
1996 PRICE £ 34.95

4D hope to launch SIX new releases in 1996 and early 1997, including compilations, PC conversions and original titles. RISC PC versions of all our most recent games are now available. We have an extensive range of BBC/ELECTRON games. We will shortly be opening a new head office on the Isle of Man.

We are happy to negotiate discount for schools or home users, buying 2 or more games.



Birds of War £ 34.95



Stunt Racer 2000 £ 34.95



Virtual Golf £ 34.95

To order simply send us a letter, or give us a call, stating the software you would like, your computer model, your name & address and payment by cheque, postal order or Access/Visa. All prices include VAT & UK P&P is FREE. This advert shows only a small selection of our games. A free catalogue is available on request.



The Dungeonr £ 34.95



E-Type 2 £ 34.95



Time Machine £ 34.95



THE FOURTH DIMENSION

1 Percy Street, SHEFFIELD S3 8AU. TEL: 0114 276 9950 FAX: 0114 278 1091



Free Ads

- A5000, 4Mb RAM, 160Mb HD, AKF18 monitor, RISC OS 3.1, Pipedream 4, PC Emulator, games, 115 magazine discs, boxed, manuals. £650. Tel: Mark (01252) 629338.
- Risc PC 486 DX4 100 second processor card. Boxed, as new with software. £175 ono. Call Alan after 6pm on Glos (01452) 614298.
- A310, 1Meg, RISC OS 2, £75. Tel: Simon on (01768) 881486, evenings.
- CC Professional flat bed mono scanner, £250. Acorn PC card, £50. All manuals and software, all fully serviceable. Tel: (01452) 714017 (Glos).
- Wanted: Impression Publisher or Impression Style package for Risc PC, reasonable offer accepted. Contact via e-mail: rpayne@argonet.co.uk or tel: (01420) 610076. May collect within Glos.
- Wanted: High density floppy drive for A3000, cheap? or will swap for IBM 286 PC + monitor and keyboard. Tel: (01484) 841687.
- For sale: Risc PC card and DOS discs. Manuals included, £95. Tel: (0786) 451 773.
- Acorn A5000, 2Mb RAM, 40Mb hard disc, RISC OS 3.11, Multiscan monitor, Learning Curve software, PC Emulator, Klik Trolley, extra software, games. £600. Tel: (01487) 710377.
- A3000, 2Mb High Resolution graphics system, 14in Multiscan colour monitor, £250. Tel: Middx 0181-967 3048.
- A310, 4Mb RAM, RGB monitor, RISC OS 3.1, ARM3, Backplane, SCSI interface, 100Mb disc, MEMCIA, PC emulator, £495. Computer workstation, £50. Tel: (Bristol) 0117-986 4671.
- Aleph One PC card 486/50MHz, 4Mb RAM, £350. Teletext, £140, PCem, £70, Equasor, £30, colour card gold, £110, Logistix, £70. Tel: (01934) 838118.
- RiscPC, 4Mb and 2Mb VRAM, Acorn 17in monitor and loads of software. ArtWorks, Ovation, Eureka, Complete Animator, Magpie, Genesis, Topographer, PC card. £1300. Tel: (01246) 239317.
- A4 laptop, 4Mb RAM, 60Mb HD. Home office and games software. Manual, mouse, charger and soft case. Light home use only. £675 ono. Tel: Somerset (01458) 443421.
- Acorn A3010 with colour monitor, various software, literature and Learning Curve. Excellent condition. £500. Tel: (01482) 708727.
- Software: Eureka v3 (boxed), £60. Touch Type, £10. 10/10 Maths, £7.50, English, £7.50. Programmable Joy Pad (unused), £9.50. Tel: Reading (01189) 426843.
- A3000 LC + monitor, £150. A3000 external IDE 330Mb Hard drive, £150. Econet sampler not RPC, £40. A3000 High Density Drive, £120. P&P inc. Tel: (01642) 787808.
- Risc PC 600, 4Mb, 515Mb, AKF60, RISC OS 3.6, £600 or possible p/x for small PC. Tel: 0113-226 0195.
- A310, 1Mb, RISC OS2, monitor, external drive interface, Watford Electronics 5.25in twin 40/80 drive, 50x5.25in blank discs, Beebug DFS reader. All boxed/instru/manuals. £350 ono. Tel: (01225) 472982 (work).
- A3000, RISC OS 3.1, 4Mb RAM, ARM3, 20Mb Hard disc, PC Emulator, monitor, £225 ono. Tel: 0181-904 2722.
- Acorn Risc PC, 5Mb, AKF60, 14in Multi scan monitor and Cumana CD-ROM drive. £800 ono. Tel: (01642) 887894.
- BBC Master, 5.25in disc drive, Philips monitor, manuals, various ROMs and software, £100. ROM Blower and software for BBC computer, £10. Tel: (01922) 409454.
- Wanted: BASIC WIMP programming book by Alan Senior and a programmers ref. manual. Tel: (01484) 642152 (ask for Azhar).
- Games! Saloon cars, £15, Sim City 2000 RPC, £20, Simon the Sorcerer, £25, Crystal Maze, £15, Wolfenstein, £15, Lotus Turbo, £10, Trivial Pursuit, £5, Lemmings Tribes, £15, Sensible Soccer, £10, Heimdall, £10, Speedball 2, £10, Cannon Fodder, £10. Tel: N Yorks (01423) 564718 (evenings).
- Wanted: Acorn A4, any version, any condition. Write full info to: iccub@treknet.is
- Cumana Indigo CD-ROM drive 300i with IDE interface, vgc, £100. Acorn JP150 Inkjet printer, great quality, £90. PowerPads 2 player, unused, £25. Tel: Evenings (01423) 564718 (N Yorks).
- Some of the best Acorn PD and shareware around. Send three first class stamps to Ross PD, 14 Lawrence Ave, Mill Hill, London, NW7 for catalogue.
- RiscPC 600, 12Mb RAM + 2Mb VRAM. 420Mb HD + DX2 PC card. Software galore incl DOS, Windows. £1300 ono. Tel: (01733) 342822 after 8pm. Quick sale needed.
- RiscPC, ARM610, 16Mb DRAM, 2Mb VRAM, 406Mb and 162Mb HD's, 486SX25 card, AKF60 monitor, PRM's, some software including Almanac, £1000. Tel: (01483) 571669.
- WANTED: Harddisk for BBC Master series. All reasonable offers considered. E-mail: paul.jagger@uk.ibm.com or call 0171-202 3309.
- Games for sale: Lemmings, Ballarena, Nevryon, Saloon Cars, Apocalypse, Chocks Away, Elite, Manchester United, E-Type, Arcade Soccer. £5 each. Also Investigator 2, £10. Tel: (01509) 263248.
- A3000 (The Learning Curve) complete with over £500 worth of educational and games software. Excellent condition, £400. Tel: (01883) 622057 (Surrey).
- BBC Master computer bought Dec 1986 & Cumana CS100 disc drive. Free to a good home. Tel: (01707) 323619 (Herts). To be collected.
- A5000 RISC OS 3.1, 425Mb HD, Multiscan monitor, PC Emulator, Genesis Plus, Desktop Database, PD software, £550. Tel: (01234) 721032.
- For sale: Burn Out, £15, Acorn Replay, £6, Simon the Sorcerer (CD-ROM), £25, Acorn User CD-ROM (offers or free with any purchase over £10). All boxed with instructions, good condition (the lot for £40 ono). Tel: (01438) 718507. Ask for Dave.
- Wanted: reasonably priced Psion or Z88 portable for young writer. Tel: (01883) 342085.
- Caligraph A4/1200 direct drive laser printer. New Mk 3 expansion card. Recent consumables. Used only for proofs. Very good condition. £600 ovno. Tel: Mike Berry on (01484) 453137.
- For sale: High Risc Racing, Dune 2, £10 each. Premier Manager, Diggers, Speedball 2, Sim City, Sensible Soccer, 2001, Saloon Cars Deluxe, £5 each. Tel: (01652) 654274.
- BBC Master 125, printer and paper, dual drive and games discs, user manuals, IBase, IWord, many extras, offers. Tel: (01268) 710119.
- A5000 with AKF18 monitor, OS 3.11, 41Mb disc, 4Mb RAM. Complete Learning Curve, Pipedream etc etc. Tel: (01494) 765155.
- RiscPC 486DX-66 PC card. Unwanted gift, £150 ono and 4Mb SIMM, £20. Tel: 0181-319 4492. Weekday evenings only please and ask for Mr T San.
- PC486 SX33 card for sale, £140 ovno. 16Mb SIMM, £90. Tel: 0181-940 1313.
- RiscPC 600, 16Mb RAM, 1Mb VRAM, 420Mb HD, CD-ROM, RapIDE card, 486 second processor, 14in AKF60 monitor, Acorn C/C++ Programmers Reference Manuals, Artworks, manuals and lots more, £1250 ono. Tel: (01932) 820785 soon!
- A3000, colour monitor, 4Mb RISC OS 3, DOS, colour printer, Learning Curve package, manuals. Educational, games, loads of software. Acorn User magazines, £325 ono. Tel: (01920) 420863.
- Windows 3.0 wanted for Acorn PC emulator. Need discs and manual please. Ring 0116-274 1633 after 6pm.
- For sale: Two Master Compacts, colour monitor, software, mags, peripherals. Also: eight speed Atapi CD-ROM drive. All offers considered. Tel: Peter on (01753) 554570.
- Risc PC 600, 20Mb, 2nd slice, 2Mb VRAM, quad CD-ROM, 540Mb HD, 210Mb HD, 17in Iiyama monitor, PC486 card, RapIDE 32 card, Publisher etc, Scanlight scanner, £1300 ono. Tel: (01453) 884560.
- For sale: Games Creator, £25, Lemmings, £10, Cannon Fodder, £12, Almanac, £8, Simon the Sorcerer, £17, Crystal Maze, £12. Tel: (01983) 863293 after 4pm (week-days).
- Canon BJC 600 colour printer, new printhead, 3 months on-site warranty plus TurboDrivers v4.04 with cable. £145. Tel: 0115-960 5718.
- RiscPC 486 card SX33 with all manuals. Hardly used, sensible offers accepted. Tel: (01706) 817570.
- Startwrite, £10, cost £35. Games: Zool, £10 ono. air Supremacy, The Last Ninja, £5 each. Some boxed, as new. Will swap. Phone Mark (01782) 523733.
- Acorn A4000, 4Mb RAM, 80Mb Hard drive, Taxan 770 Plus LR Multiscan monitor, and Acorn 486 4Mb PC card, Price includes software, manuals and original packaging £595. 500Mb hard drive, £100. Parallel port, double speed, Essex Bronze CD-ROM drive, £100. Tel: Medway (01634) 868122.
- For Sale every issue of: Beebug, Archive, Risc User, Acorn User, (BBC) Micro User/Acorn Computing, Beebon (the two only issues ever published!) and every issue of A & B Computing/Archimedes World except about 18 in the mid-1980s. Many with original binders. Phone offers to Mark Sealey (01844) 344808 or marksealey@aol.com
- WANTED for A3000: Arm 3 card, 1-4Mb Memory upgrade, HD+Interface, also RiscPC 16bit sound card wanted. Call Paul 0171-202 3309.
- Software: Eureka spreadsheet v3 (boxed), £65. 10/10 Maths, £5, English, £5. Programmable Joypad (boxed), £10. 500 Fonts, £5. Tel: Reading (01189) 426843.
- For sale: Impression Publisher and Eureka v3. Both boxed. Offers. Tel: (01223) 892891.
- A5000, 2Mb RAM, 41Mb/HD in Learning Curve package, games included with AKF 18 monitor. Star LC-24 200 colour printer, all boxed, as new, excellent condition. £650 ono. Call Paresh on 0181-675 8648.
- Wanted: Software for BBC Compact Master (3.5in disc), especially educational games, Pixel Perfect and Typing. Also like to contact other users. Tel: Bernard Baverstock on (01797) 260416.
- Risc PC 600, 9Mb RAM, 210Mb HD, 486SX33 card, AKF 60 monitor, software, 12 months on site warranty. Quick sale, £750 ovno. Tel: (01904) 414289.

Acorn User Free Ads Service

Why not take advantage of our free reader ad service? Fill in your details on this coupon (25 words maximum, one word per box below) and send it to Free Ads, Acorn User, IDG Media Ltd, Media House, Adlington Park, Macclesfield SK10 4NP. Only one ad per reader, please. Although we try to publish every ad we receive, we can make no guarantees; publication is entirely dependent on space and time constraints. We may also publish free ads on the cover disc if magazine space is short. Please fill in your name and telephone number below: these will not be published, but they enable us to contact you in case of any queries.

Your name: Telephone no:

PREMIUM BULK 3.5" DISKS

	DS/DD	DS/HD
50	12.49	15.86
100	22.49	29.38
200	44.49	56.40
250	54.99	64.63
500	107.49	117.50
1000	199.75	223.25

All Disks are certified and come with our replacement or money back guarantee. Disk Labels are included with 50, 100, 200 and 250 quantities but are extra on quantities of 500 & 1000 - 500 Labels £3.53, 1000 Labels £6.46

ACCESSORIES

3 1/2" x 100 Disk Box	£3.99
3 1/2" x 200 Disk Drawer	£9.99
Mouse Mat	£1.99
Mouse Holder	£1.99
3 1/2" Disk Cleaner	£1.99
HP/Canon Twin Inkjet Refill	£7.99

All products are subject to availability. All prices include VAT. Delivery charges:- 4 days £3.95, 48 hours £4.50, 24 hours £5.00. E&OE



SNAP COMPUTER SUPPLIES LTD

HOTLINE

01 703

457111

SNAP COMPUTER SUPPLIES LTD. Fax: 01 703 457222

Unit 12, The Sidings, Hound Road, Netley Abbey, Southampton SO31 5QA



BEEBUG

Staff Vacancy

Beebug have been established since 1982 and are leaders in the Acorn Marketplace. We are extending our range of products and services and as a result have a position available in Acorn sales and support. We can offer a busy and stimulating environment working with young and professional teams. Beebug are a small company and there are opportunities to get involved in other interesting aspects such as RISC User magazine, software, hardware, and repair operations.

Technical Support/Sales Assistant

Our technical/sales team deals with a wide range of enquiries, providing service on the phone, by letter, as well as in our showroom. We now have a vacancy for someone with a good knowledge of Acorn computers to join the team. This is a varied and interesting position and will also include opportunities to get involved in a wide range of other activities, such as representing BEEBUG at external events and shows, training to install and support networks, upgrading computers, testing new software products, and advising on the suitability of new products.

This is an excellent opportunity for someone with an interest in computing and the desire to make it their profession. Applicants should possess an Acorn computer themselves and be very familiar with its use. Knowledge of DOS and Windows would be an advantage.

Salary to £12,000 depending upon age and experience.

Applications in writing (with a CV please), to:
The Personnel Manager, BEEBUG Limited,
117 Hatfield Road, St. Albans, Herts. AL1 4JS

STAND NO
18

ACORN WORLD '96 SPECIAL

ELECTRONIC

font FOUNDRY

- Over 1,100 Latin typefaces
- Fonts for over 50 languages (Indic, Hebrew, Braille, etc...)
- Symbolic & scientific fonts
- Special educational fonts

NEW! New at Acorn World '96:

NEW! Grafitti Collection



NEW! Modern typefaces & more modern typefaces

NEW! Pick'n'Mix selection
A cost-effective way to buy high quality fonts.

Please visit our stand to see to try to buy or just to chat

For a Catalogue and Price List please contact:

The Electronic Font Foundry
11 Silwood Road • Ascot • SL5 0PY
tel 01344 875201 • fax 01344 875202
e-mail sales@effonts.demon.co.uk

CARE QUALITY & SERVICE

QUALITY INK JET & BUBBLE JET REFILLS

Our refills use only top quality inks. You buy direct from us hence our superb quality at sensible prices. Black refills for HP Deskjet 500, 510, 550, 500C, 550C, 560C, 660C, 850C CANON BC-01, BJ10E/EX/SX, BC-02, BJ200, BJ130, BJ300, BJ330 EPSON STYLUS 800, 1000, CITIZEN PROJ. OLIVETTI JP150, 250, 350. 6 refill (3 on high capacity cartridges) kit 120ml pure black. £16.99 CANON BJC600, BJC4000/4100 20 refills pure black 120ml. £16.99 EPSON STYLUS 4 refills 120ml pure black. £16.99

TRICOLOUR REFILL KITS:

HP Deskjet range 10 refills of Yellow, Magenta & Cyan 180ml £24.99 CANON BJC600, 4000/4100 10 refills of Yellow, Magenta & Cyan 180ml £24.99 EPSON STYLUS Colour/II/Is of Yellow, Magenta & Cyan 180ml £24.99

"Print Head Recovery Fluid" for unblocking nozzles £6.99 new larger size, new lower price all kits come with full instructions. Other refills available. Important: Please state type when ordering

Colour Printer Ribbons & Reloads

	Complete	One ribbon	Five reloads
Citizen Swift/ABC/240 etc.	£11.95	£6.99	£29.95
Panasonic KXP2123/2124/2180	£9.99	£6.99	£29.95
Panasonic KXP2135	£9.99	£6.99	£29.95
Star LC200 9 pin	£9.99	£5.99	£29.95
Star LC24-10/20/200	£9.99	£6.99	£29.95
Star LC24-30/LC240	£8.99	£4.95	£19.99
Seikosha SL95	£14.95	£6.99	£29.95

Special Re-Ink

For Panasonic 1080/81, 1123/24, 2423/80, 2135, Star LC200 9 Pin, Epson LQ100/150, Oki 182 to 390 range. Black bottle will re-ink 100 + ribbons £9.95

Black Printer Ribbon Reloads

Citizen Swift/ABC/120D 5 black reloads..	£9.99
Star LC10/20/100 5 black reloads.....	£4.99
Star LC24 range 5 black reloads.....	£9.99
Seikosha 1900/2400/SL95 5 black reloads	£9.99
Epson FX80 to LQ800 range 5 black reloads	£11.99
Star LC24-30/LC240 5 black reloads	£14.99

T-Shirt printing ribbons

4 col Citizen Swift/ABC/240.....	£19.99
4 col Panasonic KXP2123/35.....	£19.99
4 colour Star LC200 24 Pin.....	£19.99
reload for above	£9.99
4 colour Star LC10	£10.99
4 colour Star LC200 9 Pin.....	£12.99
reload for above	£7.99
Black Citizen Swift/ABC/120D	£9.99
Black Star LC10	£9.99
Black Star LC200 9pin	£9.99
Black Panasonic KXP1080/81, 1123/24	£9.99

T-shirt printing is simple, just print onto normal paper & iron on. One ribbon gives lots of prints. We can also supply ribbons in many colours T-shirt and normal ink.

Prices include VAT & postage. To order send cheques/PO payable to:

CARE PRODUCTS

Dept ACU, 15 Holland Gardens, Watford, WD2 6JN
or use Visa/Mastercard or Education order
Fax order line 01923 672102



Tel ORDER LINE 01923 894064

The two Daves
dive into more
software

info

Gamma redirection Author: Fred Williams

Fred has been tinkering with the palette on his RiscPC and has come up with a novel use for a long-neglected feature of RISC OS 3.5...

"One of the new features of the RiscPC that seems to have been ignored for an awfully long time is the hardware gamma-correction. So what's that then? Well...

"The video circuitry gets a pixel's worth of screen data. It converts that into RGB values using the palette. Unless, of course, you're in a 16 or 24 bit mode, in which case, the pixel defines the colour. Then – and this is the important bit – it runs the R, G, and B values through three lookup tables to determine the brightness of the pixel output to the screen. And, joy of joys, RISC OS lets you play with these tables.

"The relevant call (see the Programmers' Reference Manual volume 5, or 5a if you've got it) is:

PaletteV (vector &23)

Reason code (in R4) = 9

R0 points to a 256-byte "red" lookup table

R1 points to a 256-byte "green" lookup table

R2 points to a 256-byte "blue" lookup table

"This returns R4=0 if the video drivers 'support' the function, in which

case, your tables have been squirrelled away into system workspace. This, of course, begs the question: are there RiscPCs, or future Acorns in general, that don't support this? I don't know.

"To call this routine, you can use the "OS_CallAVector" SWI, which takes in R9 the vector number (&23 in this case) and the other registers set for whichever vector you want to call.

"Now of course, you could be really boring, and actually use it for gamma correction (which basically means biasing the tables towards 255 or 0 to make the picture brighter or darker). Or you could fade all the colours to black (or any other colour) and use it for switching smoothly between two images (which is what I was looking for when I found this call...)

"But why be dull? My program 'phases' the red, green, and blue tables independently of each other. The display is 'whatever happens to be on your desktop at the moment'. The great thing about using the gamma-correction is that it doesn't matter what 'depth' of screen mode you're in, but I can recommend switching to a 24-bit mode, loading up the 'fruit' JPEG (image 'sa09' on a RiscPC's hard drive), and then running the *Gamma*. Hit Escape when your eyes start to go funny..."

Bar code Author: Andrew Kemp

You may have wondered why there wasn't any text to accompany *Toggle* which appeared on September's cover disc, well, it's here at last.

This little piece of code helps you unearth your icon bar from under a heap of windows using just the mouse. Andrew says "the idea for *Toggle* came from Guttorm Vik's excellent text editor, *StrongED*. I am a *Zap* user myself, and I thought this feature was too useful to live without."

As you will no doubt be aware, RISC OS provides a key to toggle the icon bar – Shift F12 in fact. However, mouse addicts can simply install *Toggle* and click Menu with the mouse at the very bottom of the screen. The module works by intercepting the event vector, waiting for a suitable mouse click and then inserting a Shift F12 into the keyboard buffer. Note that because the raw mouse event is spotted, this works even if the icon bar is completely obscured by a window, although you may inadvertently bring up a menu in the process.

As an alternative, if you are a *Director* user, you might like to add the following item to the *Close* menu (in *!Director.Menus.System*):

```
Dash
Option "Iconbar"
Command ProcessKeys ^F12
```

where ^ should in fact be a true up arrow (ALT 139). Now clicking Menu over any close icon will allow you to toggle the icon bar in the same way.

Remember, remember...

Author: Keith Atkins & Scott Bonham

...the end of October. Well, yes, I know some of you may well be reading this well before Guy Fawkes night, but as this is the November issue, we feel duty bound to provide something in the way of pyrotechnics. In fact, we have not one but two little demos. The first is from Keith Atkins of Bishops Waltham.

It's basically one of those 'lots of sparks pouring out of a box' numbers. When it's finished its stuff, click Select for another burst or Adjust to quit. Holding down Select will provide a continuous stream of sparks. The demo can be tuned according to your machine's capabilities by changing some of the variables.

MAXSPARKS is the maximum number of simultaneous sparks (and tails) and can be increased with a corresponding reduction in speed. SPK_OCNT sets the length of a spark's tail and values other than 16 can give interesting, if not particularly useful results. !DELAY sets the time lag between stars and should be set to give a graceful display according to the speed of the machine. By default it is one which is suitable for the A3000 on which the program was written. !MAXBURST is the total number of stars in a burst.

Our second seasonal offering comes from Scott Boham of Romsey in Hants. This is more your 'starburst' affair. Again written in

machine-code for speed, this demo also plots the progress of a load of stars (500 by default) as they explode from a randomly chosen point and fall under the influence of gravity. This program runs rather too quick on a RiscPC, so you can either increase the number of stars to something ridiculous (try 10000!) or add a few more WAITs by copying the "OS_Byte" line a few times after MOV r0,#19.



On the rebound...

Author: Jamie Shotton

This is really just a much-enhanced version of Alistair Turnbull's little bouncing game from the September 1996 issue. !Rebound features custom game screens and two player games. It is a good example of the ultimate in one-key games.

To get a flavour of the game, try one of Jamie's example screens out (there are two supplied on the cover disc). Install *Rebound* in the usual way. Then drag *Maze* onto the *Rebound* icon. Now click on the icon with Select and choose Custom game. Select Start the Game and play.

The object is to guide your bouncing dot to the safety of either the right side of the screen or (in the case of some custom screens like *The Maze*) to the purple area. Each player has only one key which acts as an upward thrust. For player 1 this is Space; for player 2 Enter. Otherwise, it is only gravity and the bouncing effect of the white walls that determine where your dot ends up.

Dark blue areas will, when hit, unlock light blue ones – you will need to do this to finish *The Maze*. Yellow areas are fatal and should be avoided at all times. It is also fatal to fall off any side of the screen other than the right. Red areas, when encountered, will transport a player to a random position – so beware!

To change the number of players, select Players from the icon bar menu. Player 1's dot is light blue and player 2's is green. To

have another go at the same screen simply click on the *Rebound* icon with Adjust.

When playing a standard game you have the choice of three block styles and can choose the game number. This is effectively a random seed from which the pattern of blocks is determined – the same number always produces the same screen. Select Randomize to pick one at random. After a game you are able to view the high scores or enter your name amongst them if you have done particularly well.

To create your own custom screen, use the Custom submenu from the icon bar menu. (If you just select Custom it will show the currently loaded custom screen if there is one.) When creating a new game,

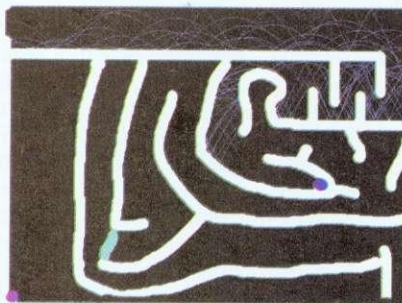

enter the name and that of the designed (i.e. you!) You can add a yellow border if required and blocks may be shown along the left side. When ready, select Edit to

enter the editor proper.

While editing, Select draws fat lines and Menu thin ones. Adjust finishes the editing process. A number of keys have effects during editing:

W	selects white (normal wall material)
B	black (for deleting)
Y	yellow (fatal to players)
P	purple (hit this to finish)
L	locked (shown as light blue)
U	unlock (shown as dark blue)
T	transport (shown as red)
H	hidden (shown as white in the game but which cannot be hit by the player)
Insert	shows yellow border and side blocks temporarily
Alt	draws a rectangle in the current colour

Jamie uses his own file format for saved files and the screens are compressed. The compression process takes a few seconds. The game needs to be stored on a writable medium since it creates a blank high score table, so copy it to your hard disc or another floppy before use.

Rebound was written in C on an A5000 and should work on all machines. It uses mode 27. Inside the !*Rebound* directory is a file called speed. Change the number in this file to control the game speed – the higher the number the slower the game.

Sci-fi hi-fi

Author: Graeme Jefferis

Time to dig out your copy of *Flux* and give this *Digital Symphony* track a spin. It is certainly one of the best and most different we have received. The creator of *60sSciFi* says it sounds a bit like 'Lost in Space'.

Flux is the ideal tool for playing this track as with just a few presses of the space bar you can conjure up state-of-the-art early Dr Who-like special-effects to match the mood of the music.

Pretty lights

Author: David Llewellyn-Jones

"This is a graphic doodle" says David Llewellyn-Jones in a moment of understatement. In fact, this program continues our seasonal pyrotechnic theme in that if Monet had ever gone into the firework business, this is probably what he would have come up with.

David wrote *Lights* on a RiscPC but says it should work on any machine which supports mode 28, albeit at a more sedate pace. Perhaps the most remarkable thing about this demo is that it is just 150 lines long.

The program is interactive in such a way that pressing and holding a mouse button down has an 'explosive' effect - try it and see. You can also change the *Lights* icon in *!Sprites* which double as the brush used for plotting. Because of the way the program works, even colours should be used for the foreground and odd ones for the background. The bottom bit of each byte is effectively used as a mask. "It's difficult to explain the effect which altering the sprite has" says David. "It's best just to experiment."

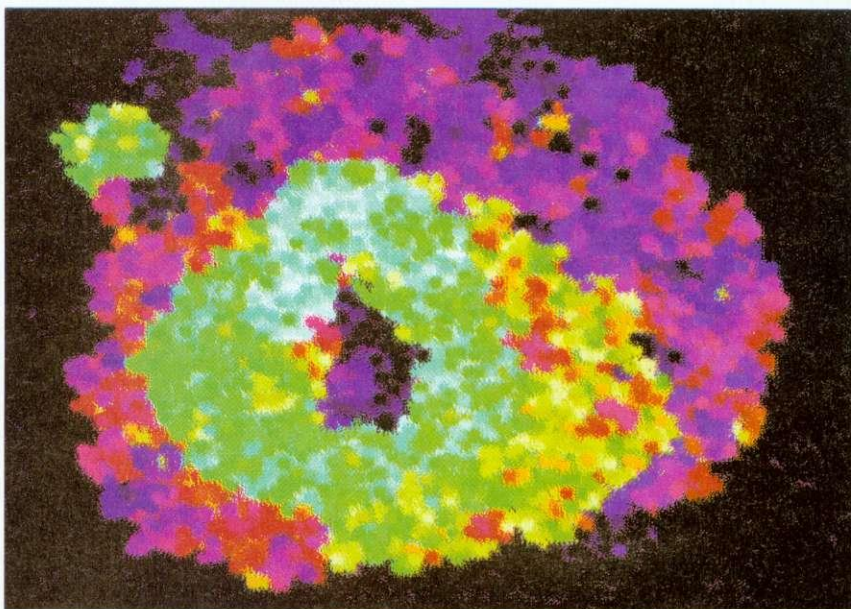

Fork show & Julia - see sir?

Author: Alistair Turnbull

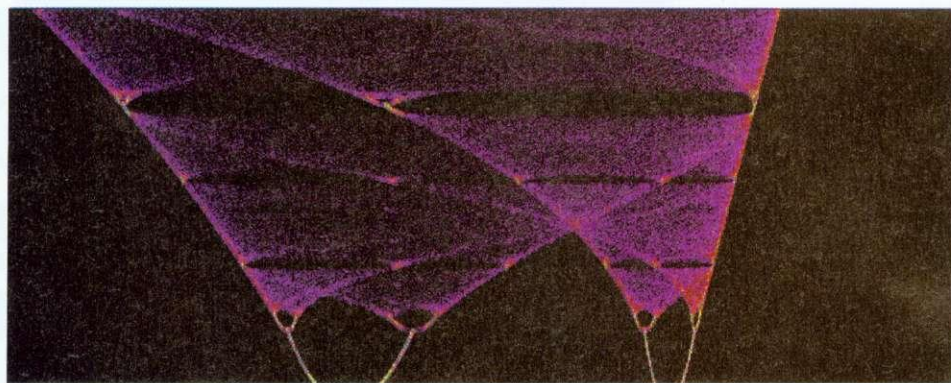

A pair of graphical masterpieces, the first goes under the rather enigmatic title *CX(I-X)*...

"This is a glorified bifurcation diagram, named after the formula that generates it. The glory consists of density-dependent colouring and motion blur. I've redefined the mode 15 palette to make it smoother.

"When it appears to have stopped, it is actually moving gently up and down within a pixel, because this produces a pleasing sparkle."

We've rather lost count of how many fractal demos we've carried in these hallowed pages over the years. It takes a particularly fine programming talent to come up with something in the genre that's worthy of fresh column inches. In this case, Alistair has dramatically improved his earlier renderer of that most famous of sets, in the shape of *Julia2*.

"This is an updated version of the program you carried over a year ago (in June 1995 in fact). This time, it's written properly. I've managed to squeeze 12 iterations out of each recursive level, as opposed to six, and I've managed to increase the maximum number of iterations to infinity by detecting loops. It's about twice as fast, too.

"It should be possible to write a version that draws the Julia sets for different functions. In particular, I'd like to do the trigonometric and hyperbolic functions using Runge-Kutta (as used in last month's *PoorJenny*). You may see this in the future." Well, watch this space...

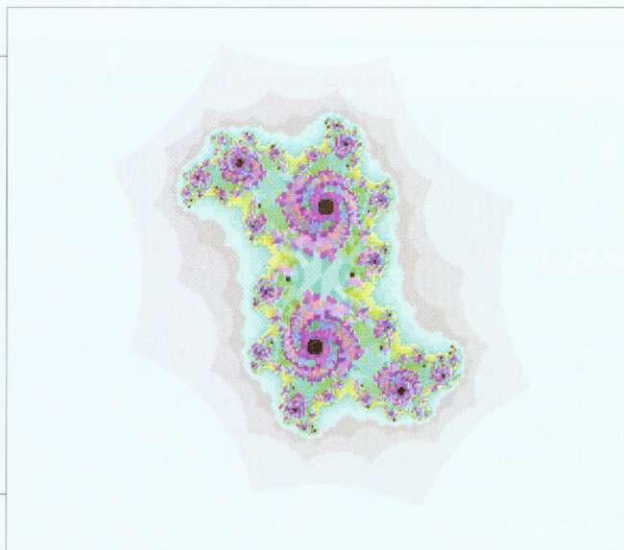

DOSsing around

Author: Dr Tony Lindop

This is something of a reunion issue, as our next contributor was also featured back in June 1995 with Alistair Turnbull and Jamie Shotton. This time Tony provides a little help for those using PC cards or PC emulators. *!DOSfsmmap* sets up a whole host of mappings from DOS filename extensions to Acorn filetypes.

"Run this application to generate a set of RISC OS sprites which correspond to DOS file extensions. DOS file extensions are mapped to RISC OS file types via the DOSMAP statements in the *!Run* file. These statements are in alphabetical order of the DOS file extensions. A set of Sprites have been included in the *!Sprites* file, which correspond to the RISC OS file types. The individual sprites are listed in descending numerical order.

"Sprites for filetypes &FFD to &405 have been extracted from the *Acorn User* CD-ROM and PD software. Sprites for file types &OFF to &0BD have been either generated by hand or extracted from Windows Icons."

A list of all the extensions supported is provided on the disc as a text file *list*. This details the RISC OS filetype, those DOS extensions to which it corresponds and a brief description of the nature of the filetype. If space permits, an *Impression* version of the document will also be included. Tony would like to acknowledge R J Cohn (AU February 1996) for the original idea and list.

To compliment *DOSfsmmaps* Tony has also supplied a pair of BIO modules. For those new to this magazine, *BIO* was a modular utility we carried many moons ago and to which we have added modules from time to time. In case you haven't got a copy, the cover disc includes a fresh one with Tony's two new modules.

The purpose of the modules is to convert PC icon files to Acorn sprites and vice versa. Simply drop the source file on the appropriate icon and after processing, save in the normal way. Tony used these BIO modules to generate some of the sprites used in *DOSfsmmaps*.

A challenge

It's a while since we set you a programming challenge, so to get your well-rested brain cells whirring, here's a little programming exercise for you.

The challenge is to write a graphic ditty that uses only circles to do its stuff. By way of an example, you will find the elegant *Shells* by our own Mr Lawrence.

The delicate shell-like creations are simply produced by plotting a series of rings of

filled circles in fading hues. The program can run in 16, 256 or (on a RiscPC) 32768 colour modes - just alter the value of cols at the start. If you think you can come up with a similarly impressive circle-based display, send it in to us.

Your demo can be in C, Basic, machine-code or whatever your like. And you can use whatever methods you like to do the plotting - you just musn't cheat, circles only - no lines, rectangles or sprites - not even circular ones.

The judges (i.e. we) have the final say and will use our unfathomable expertise and discretion to select

the best of your efforts for publication. Of course, originality will stand you in good stead. Please send your entries to us by **November 30th 1996** and mark your envelope *Circle Challenge* please.

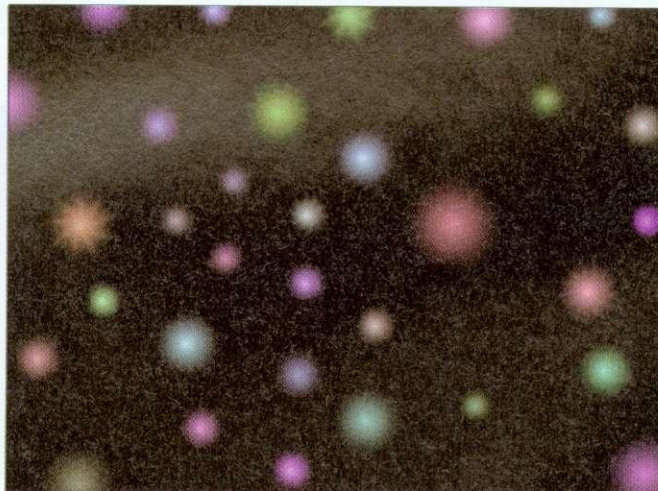

*QUIT

Send your programs, hints, tips and musical offerings to:

*INFO, *Acorn User*, IDG Media, Media House, Adlington Park, Macclesfield SK10 4NP

or, if your submission is **100K or less**, e-mail us (including your real address please) at:

austarinfo@idg.co.uk

You needn't include a letter but **please put**

your name, address and program title on every disc and include a text file containing your name, address, disc contents and program details. Any extras like saved screens, drawfiles and background information are a pleasure to receive. A SAE will ensure your discs are returned. *info submissions only please - if you are submitting material to another section of the magazine it will be processed more quickly if you send it separately.

Compatibility table

Program	RISC OS 2	RISC OS 3.1	RISC OS 3.5+
Atkins Fireworks	No	Yes	Yes
Boham Fireworks	No	Yes	Yes
Shells	Yes	Yes	Yes
!Bio	No	Yes	Yes
Lights	No	Yes	Yes
Rebound	No	Yes	Yes
CX(1-X)	No	Yes	Yes
Julia 2	Yes	Yes	Yes
Gamma	No	No	Yes



Programs available for all ages and abilities.

- For school and home use •
 - PC and Acorn formats •
- Send for our free catalogue.

4Mation
Publishers of
quality educational
software since
1983.

4Mation Educational Resources
14 Castle Park Road
Barnstaple
Devon
EX32 8PA
☎ (01271) 25353

MATHSBOOK

Save up to £10 on the TALKING version of MATHSBOOK!

Sums can be hard work for some children. What you need is a way to get them done on the screen - and MathsBook does just that. What they see looks just like an exercise book, right down to squared paper and 'teacher's red' helpful comments! Fully configurable from tens and units to thousands and decimals, MathsBook tracks progress, automatically moving learners up and down difficulty levels. It even keeps (and prints) records, so that you find out what they can really do. By Marshal Anderson, author of ScreenTurtle, and whose Music Box won the BETT '95 Gold Award. For home and school.

Pack 1 (+ and - RISC OS 3 only) normally £35 + VAT, Site Lic. an extra £35 + VAT. Special Reader Offer: £5 off EACH price - send this ad. Pack 2 (x and div) & PC versions: January '97.

Toplogika Software, FREEPOST, Islington Wharf, PENRYN, Cornwall TR10 5BR
tel (24hrs): 01326 377771 fax: 01326 376755 e-mail: sales@toplogika.demon.co.uk
FREE DEMOS from our WEB site: www.toplogika.demon.co.uk

Educational Software Publishers since 1987. GOLD Award Winners BETT '95, SILVER BETT '94

StrongARM for £116 - offer available until the end of December 1996
New reduced prices on Risc PCs

Acorn Risc PC	CD ROM Drives suitable for Risc PC
Risc PC600 4Mb HD540 14" monitor (AC864A/F90) £1299	For a Quad speed CD ROM drive add £67
Risc PC600 4Mb HD540 17" monitor (AC864A/F90) £1675	For an Eight speed CD ROM drive add £114
Free quad speed CD ROM drive with Risc PC600 4Mb	Panasonic PD CD ROM drive/650Mb optical disc internal £479
Risc PC700 5Mb HD540 14" monitor (AC877A/F90) £1549	Panasonic PD CD ROM drive/650Mb optical disc external £537
Risc PC700 5Mb HD540 17" monitor (AC877A/F90) £1925	The Panasonic drives require a SCSI interface.
Free quad speed CD ROM drive with Risc PC700 5Mb	
Risc PC700 10Mb HD1Gb 14" monitor (AC875A/F90) £1799	PC Cards
Risc PC700 10Mb HD1Gb 17" monitor (AC875A/F90) £2175	PC card 5x86 ACA57 £469
Free eight speed CD ROM drive with Risc PC700 10Mb	Ordered with Risc PC £351
Upgrade the Quad speed drive to eight speed add £47	Exchange from SXL/33 £351
Upgraded Risc PC	PC card DX4-100 AGA56 £351
Risc PC600 13Mb HD1275 14" monitor (AC864A/F90) £1591	Ordered with Risc PC £234
Risc PC600 13Mb HD1275 17" monitor (AC864A/F90) £1967	Exchange from SXL/33 £234
For a 1620Mb disc add £24, or add £60 for a 1620Mb disc	PC card DX2-66 £293
Alternative Monitors	Ordered with Risc PC £175
Iiyama MF8515F 15" £299 or £35 added to 14" prices	Exchange from SXL/33 £175
Iiyama MF8617E 17" £575 or £310 added to 14" prices	PC card 486SXL/33 ACA52 £234
Iiyama MF9017E 17" £644 or £380 added to 14" prices	Ordered with Risc PC £116
<i>Canon printers, Syquest, hard discs, modems and software at competitive prices. We repair computers, monitors etc.</i>	Memory
	For Risc PC and A7000
	Prices at 10th Aug 1996
	4Mb £34
	8Mb £51
	16Mb £94
	32Mb £195
	1Mb VRAM £117
	2Mb VRAM £212
	Upgrade VRAM
	1 to 2Mb £106
	All prices include VAT
	We operate Acorn's 20/20 interest free purchase scheme, subject to status.

Telephone/Fax 01332 690691 email to - selective@globalnet.co.uk
8 Old Gate Avenue - Weston on Trent - Derby - DE72 2BZ
Prices are subject to change, we reserve the right to modify our prices accordingly. (E&OE)

RISC PC MEMORY/INTERNET

£177.42 for 32Mb or £90 for 16Mb or £47 for 8Mb (call for latest prices) inclusive of VAT and Postage - all swap out if not happy or money back.

2Mb FREE Web Space? Just £9.40 per month with local UK phone rates anywhere with 7 day telephone help support on the Acorn friendly Enterprise network. Credit cards accepted. 10% off Ant Internet Suite.

Tower Electronics Ltd 01651 891 069
<http://www.enterprise.net/tower-risc>

Calendar

Kudlian Soft

Kudlian Soft, 8 Barrow Road
Kenilworth, Warwickshire
CV8 1EH Tel: 01926 842544

Great for Making Calendars at Christmas!
Ideal for Displaying Children's Work!

Features:

- Produces monthly, bi-monthly and yearly calendars
- Memo style calendars now available
- Range of border styles with multiple colour schemes
- Fully WYSIWYG preview window
- Imports Draw and sprite files, (plus JPEG under 3.60)
- Flexible printing options

Price: £30 + V.A.T. (£35.25 inc. V.A.T. and P&P)

"Easy to use, allows effective and highly decorative results to be produced in seconds."
"It is easy to create individual calendars with this package... It is as simple as it is effective."
- Archimedes World

The WHOLE WORLD in your HAND?

We can't promise that, but **NSTORE** for the **ACORN POCKET BOOK II** palmtop computer gives you all this for only **£49.95 + V.A.T.**

sophisticated automated report writing
+ a large bank of over 750 teacher comments
+ all the National Curriculum Level Descriptions
+ detailed National Curriculum Record Keeping
+ word & phrase search of the National Curriculum
+ comprehensive exporting and importing of data

Full details from: **H.S.SOFTWARE, FREEPOST, SWANSEA SA2 9ZZ**
- OR - telephone: (01792) 204519 - OR - visit our web site at:
<http://www.argonet.co.uk/h.s.soft>

FIVE STAR MARKETING

Our *NEW* demo/catalogue disc for just £1 or buy any pack and get our demo disc free. Sorry, no credit card facilities available.

OUTSTANDING HIGH QUALITY PUBLIC DOMAIN SOFTWARE

EXCELLENT PACK OFFERS

Games 1 : Games 2 : Games 3 : Games 4 : Draw Clipart 1
Draw Clipart 2 : Draw Clipart 3 : Draw Clipart 4
Educational 1 : Utils 1 : Utils 2 : Utils 3 : *NEW* Utils 4
Sound Sample 1 : Sound Sample 2 : Sound Sample 3
Each pack has three fully archived discs. One pack for £3.75 - Two packs for £7.20 - Three packs or more at £3.50 for each pack.

We are distributors of educational software from Sherston and 10 out of 10. We offer at least 10% saving on their recommended prices. Official orders are welcome. For free catalogues and further information write to the address below or call 0181 950 4973.

Five Star Marketing, 4 Shepherds Walk
Bushey, Herts. WD2 1LZ.

BACK issues

Missed out on one of our previous issues? Now's your opportunity to bring your collection up to date. But hurry: stocks are limited

Issue 163 – Christmas 1995

- Unusual gifts for Christmas
- PD round-up ● Alone in the Dark ● Global Effect demo
- Online Media Technology

Issue 164 – January 1996

- Hybrid machines ● Travelling with a Pocket book ● Virtual design ● Acorn Educational Products & services Catalogue
- Top Model demo

Issue 165 – February 1996

- Word processing round-up
- The Clan ● Virus protection
- Sibelius at the Royal Academy ● Resource editor demo

Issue 166 – March 1996

- Video editing ● Multimedia packages ● Graphics applications ● Colour printers
- Alone in the dark demo
- FSCK

Issue 167 – April 1996

- Reviews ● Power DTP
- Acorn Australia ● Swarm
- Float ● Glossary

Issue 168 – May 1996

- Bulletin Boards ● Internet explained ● PD CD-ROMs reviewed ● Demo of Optical

Issue 169 – June 1996

- Hands-on review of Studio 24 Pro ● RISC OS running Quasar ● Clip-art CDs reviewed ● Baka Chal!



Issue 170 – July 1996

- PowerWave ● The Hydra multi-processor board ● Sibelius version 3
- Acorn User CD-ROM No. 2
- Tank Attack

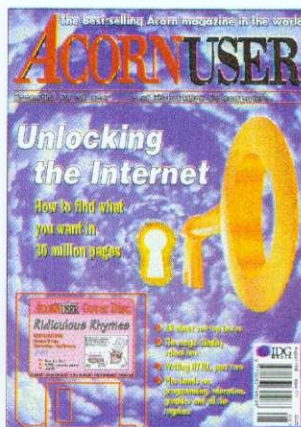

Issue 171 – August 1996

- Unlocking the Internet ● Writing HTML ● The Lindis Technology bus
- Set-top boxes ● Ridiculous Rhymes demo



Issue 172 – September 1996

- Ovation Pro ● Printer survey results ● Acorn in Holland
- Images in HTML ● Customising your desktop

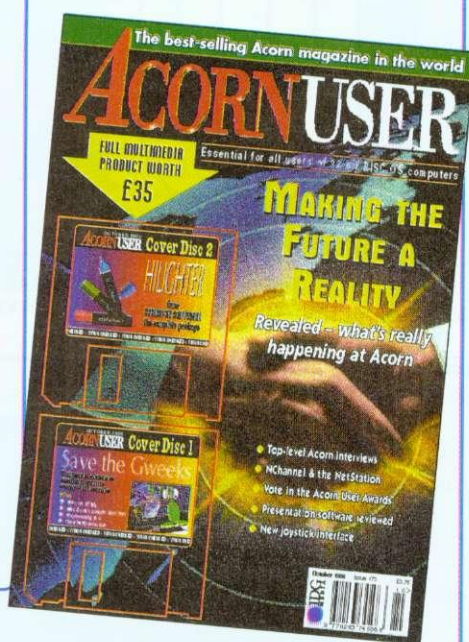

Issue 173 – October 1996

- Top-level Acorn interviews
- NChannel & the NetStation
- Presentation software
- Hilighter package ● Save the Gweeks

Order form

- | | | |
|--------------------------|--------------------------------|-------|
| <input type="checkbox"/> | Issue 163, Christmas 1995..... | £3.75 |
| <input type="checkbox"/> | Issue 164, January 1996..... | £3.25 |
| <input type="checkbox"/> | Issue 165, February 1996..... | £3.25 |
| <input type="checkbox"/> | Issue 166, March 1996..... | £3.75 |
| <input type="checkbox"/> | Issue 167, April 1996..... | £3.25 |
| <input type="checkbox"/> | Issue 168, May 1996..... | £3.25 |
| <input type="checkbox"/> | Issue 169, June 1996..... | £3.25 |
| <input type="checkbox"/> | Issue 170, July 1996..... | £3.75 |
| <input type="checkbox"/> | Issue 171, August 1996..... | £3.25 |
| <input type="checkbox"/> | Issue 172, September 1996..... | £3.25 |
| <input type="checkbox"/> | Issue 173, October 1996..... | £3.75 |

Name

Address

.....

.....Tel No

Please allow 14 days for delivery.

Send cheques payable to IDG Media to:

Acorn User Back Issues, Database Direct,

FREEPOST, South Wirral L65 3EB

or phone 0151 357 1275

Fax: 0151 357 2813

E-mail: database@dbdirect.demon.co.uk

- Please tick if you do NOT wish to receive further information or special offers

SOFTWARE SHOWCASE

EDUCATION

MAUDENS  95
 "Millside", 133 High Street,
 Wollaston, Stourbridge,
 West Midlands, DY8 4NZ.

We have been supplying education establishments for 16 years

- Acorn Authorised Service Centre
- Authorised Microsoft reseller
- PC Developers and Category 5 Networking Specialists
- New Showrooms with complete range of Acorn machines
- MAIL ORDER - It is our policy to match most prices on offer
- Come to our showrooms and view the Internet

0% Finance on PC and Acorn Machines
 With 16 years of service you can't go wrong with Maudens
 Tel: (01384) 444433 / 833300. Fax: (01384) 441655

**Xavier Software for
 Dyslexia / Literacy skills**

Wide range of specialist programs, available on 28 day approval. Digitised speech throughout. See review in Acorn User Dec. 95 or CDROM January 96. Illustrated catalogue from:

Xavier Educational Software Ltd.
 Psychology Dept, University College of Wales, Bangor, Gwynedd
 LL57 2DG Tel: 01248-382616 Fax: 01248-382599
<http://www.psych.bangor.ac.uk/deptspsych/xavier/>
 email: pss005@bangor.ac.uk

DEALER

AUTHORISED ACORN DEALER

Armtech
 SALES & REPAIRS

16 / 8 Meg Simms £109 / £58 Inclusive
 Visit Our Web Site At
<http://www.armtech.demon.co.uk>

86 Meadowbank, Moor Lane, Holway, Holywell, Clwyd.
 CH8 7EF Tel/Fax :- 01352 715840
 E-Mail mike@armtech.demon.co.uk

GAMES

FREE 14 DAY HOME TRIAL

What we will do is send you our latest five quality budget games for you to try in the comfort of your own home.

Any Risc OS with 1 Mb or more

GENERATION DESIGN
 2 Whitecliff Gardens, Blandford Forum, Dorset
 DT11 7BU
 Tel: 01258 452507
 Email: genden@argonet.co.uk

GAMES

Modus Software **LAST OFFENCE**

£30 fully inc. The best action platformer on an Acorn machine, with a ton of features you've never seen!

Modus Software
 89 Glenacre Rd
 Cumbemauld
 Glasgow G67 2NT
 Tel: (01236) 722202
 email: modus@digibank.demon.co.uk

DEMO AVAILABLE
 Send disc, SAE & computer specs

BUSINESS SOFTWARE

DSL SUPPLIES
NOVEMBER SPECIAL OFFERS!

35% OFF ARMLOCK!
 Single User £22.75 Save £12.25!
 10 User £90.35 Save £48.65!

SPECIAL OFFER ON SQUIRREL THIS MONTH ONLY!
 Single User LESS 37% £87.50 Save £48.65
 Multi User 35% OFF - £361.40 Save £194.60

DSL SUPPLIES
 ST MARGARET'S LANE
 FAREHAM
 HANTS PO14 4BQ
 TEL/FAX 01329 841600

All prices exclude post & packing



CLIPART

SOFTCENTRE 25, TOWNGATE OSSETT WAKEFIELD WYLS GB. TEL: 01924 272511 OPEN 9am - 6pm MONDAY to SATURDAY

NEARLY 200 CD TITLES NOW IN STOCK

***** NEW *****

BIG NEW RANGE OF GLAMOUR DISCS
 RANGE OF 27 GLAMOUR CD'S FROM JUST £7
 SEND FOR FREE CATALOGUES

UTILITIES

BLINDS

"At last a truly professional Pinboard!"

Blinds is the easiest, but most powerful, file and application organiser on the Acorn platform. It makes managing your files, directories and applications virtually effortless! Order a copy of *Blinds* and see why hundreds of other satisfied Blinds owners would now not be without *Blinds* on their computer.

- ★ "A superb program, how do you do it?"
- ★ "...wouldn't be without it now!"
- ★ "A very useful application. Well done."
- ★ "One of the few programs that I use all the time!"

In fact we are so convinced that you too will find *Blinds* indispensable and a doddle to use that we are prepared to back up our claims by offering you a **28 day money back guarantee** if you buy a copy directly from us!

Blinds costs only £25.95 fully inclusive of postage, etc. No V.A.T. *Blinds* requires RISC OS 3 or better. A demonstration disc is available free of charge on receipt of a A5 size SAAE. Or download a copy of our Web site at <http://www.cybervillage.co.uk/acorn/qs/>

Blinds is available from:
Quantum Software at 35 Pinewood Park, Livingston, EH54 6NN, Scotland. Tel: 01506 - 411162

GRAPHICS

Dixon & Dixon 
 35 Rokeby Drive, Kenton
 Newcastle upon Tyne NE3 4JY
 0191 2853 042 North East Acorn Dealer

Textile Transfer Paper
 Truly Remarkable and Revolutionary
 Print it - Iron it - Wear it

4 Sheets A4 £8	30 Sheets A4 £44	100 Sheets £140
-------------------	---------------------	--------------------

Hobby Kit - includes 2 T-Shirts and 4 Transfer sheets 12.99
 MouseMat Kit - Your favourite Pin-Up to stare at 5.99

Refill your inkjet with UVLR ink
 No Fade Ultra Violet Light Resistant ALL COLOURS
 3 Refills (60 ml) for 18.80 inc VAT & postage
 FLUSH SOLUTION (why not change your cartridge colour)
 Flush out the old refill with new £5.00 inc VAT & postage
TWIN REFILLS FOR ALL INKJETS FROM 11.98
 Cartridges for JP150's £19.96

FLYPRINT	£ 19.97
DEAD CERT	£ 19.00
KEYBOARD EMULATOR	£ 9.99

Prices inc VAT £1 postage UK mainland

PRINTING

P.R.I.N.T.M.A.K.E.R.
CUT VINYL BUREAU
 LETTERING, LOGOS & DECALS
 cut in self-adhesive vinyl on our plotter from Acorn DRAW files.
 Any size, colour and quantity.

Ideal for Signs, Van sides, Car Decals & Exhibition graphics.

Tel 0118 956 7947 Fax 0118 956 1112
 14 Eldon Terrace Reading Berks RG1 4DX
 Contact Chris Mercier ☒ Email: mercier@argonet.co.uk
 See our web site <http://www.cybervillage.co.uk/folio/printmaker>

SOFTWARE

DON'T READ THIS ADVERT
 Unless you're interested in buying low cost software.

For Risc OS 3.1 and above: Trellis (the Adventure Interpreter) £8.99
For Risc PC Machines:- Escape from Exeria £7.99
For Risc OS 3.1 Only :- Floopy £3.49 Drop Rock £3.49 Switch £3.49 Guardians £3.49 Escape from Exeria £4.99
Risc PC Special Offer:- Trellis + Exeria - £15.00
Risc OS 3.1 Special Offer:- Trellis + All 5 Games - £25.00
Soft Rock Software, FREEPOST (BS 7978) Westbury-on-Trym, Bristol, BS10 7BR
On the WWWeb:- http://www.argonet.co.uk/softrock
All prices include postage. Please allow 28 days.

Sounds simple

Mike Cook tidies up his sound system using an audio switching unit

Some people are very tidy. A past head of our department used to say: 'The state of your desk reflects the state of your mind'. He said it once too often to someone who was about to retire. He replied: 'I suppose yours is empty!'

Now I have a certain clutter threshold, which is naturally higher than my wife's - once this is triggered, a mass tidy up ensues. The same thing has just happened with the sound system on my computer. It was all very well at first, but then I fitted a 16-bit sound upgrade and the sound was too loud, especially with the PC card. Then an internal CD drive was added and finally the FM radio I did for the September issue - something had to be done.

That something arrived in the form of the TDA7318 chip I spotted in the latest Farnell catalogue. It was called a *Digitally Controlled Stereo Audio Processor* so I sent off for the data sheet to see exactly what it would do.

Basically it can take four stereo inputs, switch between them and control the volume bass and treble before squirting the signal to two pairs of speakers. The great beauty of this chip, however, was that it is controlled by an I2C interface. This makes it ideal for controlling a permanent unit housed inside the computer as this interface is already built into the computer and we don't use any of the computer's precious interfacing lines.

A quick look at Figure 1 will show you the function of the chip. Remember, this is a stereo chip so there are, in effect, two of these systems inside the chip, for both left and right channels. After the input switching one of four gains may be selected, then the volume control cuts down the signal before passing it on to tone controls. Finally the signal is sent to two outputs - front and rear speakers. These outputs can also be cut

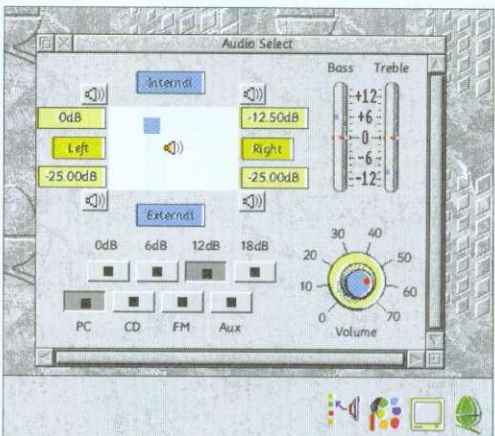

down allowing you to balance between left and right channels and also between front and rear speakers. This was primarily designed for a car system where you can push all the sound to the back passengers during particularly annoying tracks of 'The Lightning Seeds' album.

Now, gain is simply a ratio of the signals at the input against those at the output, but for audio purposes this can be misleading. This is because the ear works in a logarithmic fashion so that an increase of gain of, say, five, sounds different depending on how loud it is to start with. If the sound is quiet it will be a big jump but if it is loud you will hardly hear any increase at all. So to make things easier sound is often expressed in terms of Bells, which is simply the log to the base 10 of the gain.

Well, it works out that a Bell is a bit big, giving numbers less than one for a gain representing a doubling of the sound, so we actually use units of one tenth of a Bell or a deci Bell. This is almost universally abbreviated to dB and pronounced 'dee bee'. So to express a gain in dBs all we need to do is to use: 10 Log (Gain) . As this is power gain and we are normally dealing with voltage measurements another correction is made so that for most practical purposes we use: 20 Log (Gain) .

Now the benefits for this are that it is very convenient to talk about gain in a way that is easy to understand. A doubling of the volume is simply an increase of 6dB no matter what the original level is. Therefore in a system like this we can get the overall gain by simply adding up the gain of each section as expressed in dBs.

A gain expressed as a negative number is a reduction or an attenuator and exactly cancels out positive gain. In this chip the gain just after the switch is positive and all the others are negative - bear this in mind when looking at the effects of each control.

Now it turns out that there is surprisingly little to add to make this chip work; the full circuit is shown in Figure 2. The inputs are capacitively coupled and the capacitor between pins 6 and 7 couple between the switch gain output and the volume input. This is for the right channel with pins 16 and 17 doing the same job for the left one.

Pins 20 and 21 provide the bass filter and pin 5 the treble for the right side. Again these are complemented by pins for the left side. The two

Figure 1: The functions of the TDA7318

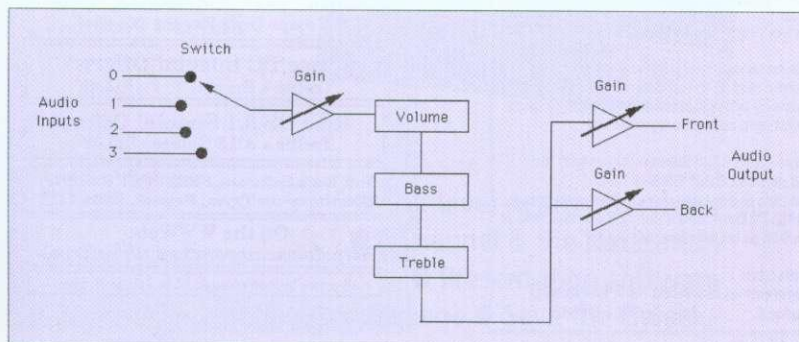

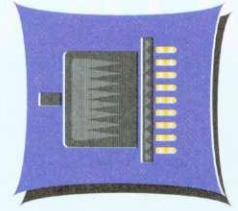

pairs of outputs can be connected to the computer's internal amplifier through capacitors and the I2C interface signals are connected directly from the signals from the expansion back plane. The only slight snag is that this chip works off 9 volts not the usual 5, so we have to use a regulator to cut the computer's internal 12 volt supply down to the right value.

There could be a slight snag with construction - the chip comes in two types the TDA7318 and the TDA7318D, the difference being the packaging. When I made this project I could only get hold of the TDA7318D which is the surface mounting version, therefore, I also got a conversion header on to which you can solder a surface mount chip and get a normal 0.1' spaced IC.

Unfortunately the chip is slightly wider than the header and so I had to resort to bending the legs of the chip to make it fit, resulting in a very delicate soldering job. If you can, I would recommend you get the DIP (Dual Inline Package) version. I built the circuit on a small piece of veroboard hanging inside the computer. I arranged the connections so that the board came between the internal sound source and the internal amplifier using the front speaker output from the board.

There is only one speaker in my RiscPC 600 but when you use the external speaker socket you get stereo. I also brought out a socket for another pair of amplifier/speakers from the rear speakers output of the board. A word of warning here; the inside of the computer is sprayed with a conducting layer so don't rest the board on the inside plastic or some connections will short out.

So with construction over we have to write the software. This device has a fixed address of &88 on the I2C bus so we can only fit one on any bus. To control this device you simply write a byte to that address. The upper significant bits of that byte determine the function and the other bits give the data for that function - this is shown in Table I.

For example if the two most significant bits are zero, the other bits determine the attenuation of the volume control in steps of -1.25 dB. As there are six bits this gives a maximum value of -78.75 dB which is very close to nothing coming out. The other controls work in a similar manner - note the audio switch which has both the input switch position and the input gain.

For this project the software is not quite straightforward although it could have been. I could have simply used a software control for each parameter but you can put a bit more intelligence into it to make it very useful - it's called *!AudioSel* on the cover disc. The tone controls are implemented as simple sliders and the volume as a rotary knob.

Note the numbers on this knob represent the attenuation, but, because people expect to get a loud sound when the volume control is set to a big number, the numbers fed to the chip are inverted. This means that when you set the volume control to zero the chip is told to attenuate the signal by the maximum -78.75 dB, whereas a volume setting of 78.75 will produce zero attenuation.

It is in the speaker's attenuation where I have

gone to town with the software and it took some time to work out. Basically all the user has to do is to drag a square around a box.

However, this controls the sound position in two dimensions thus allowing you to fade between left and right and front and back at the same time. Clicking on the central speaker icon puts everything back to no attenuation. In addition, by clicking on each speaker you can mute

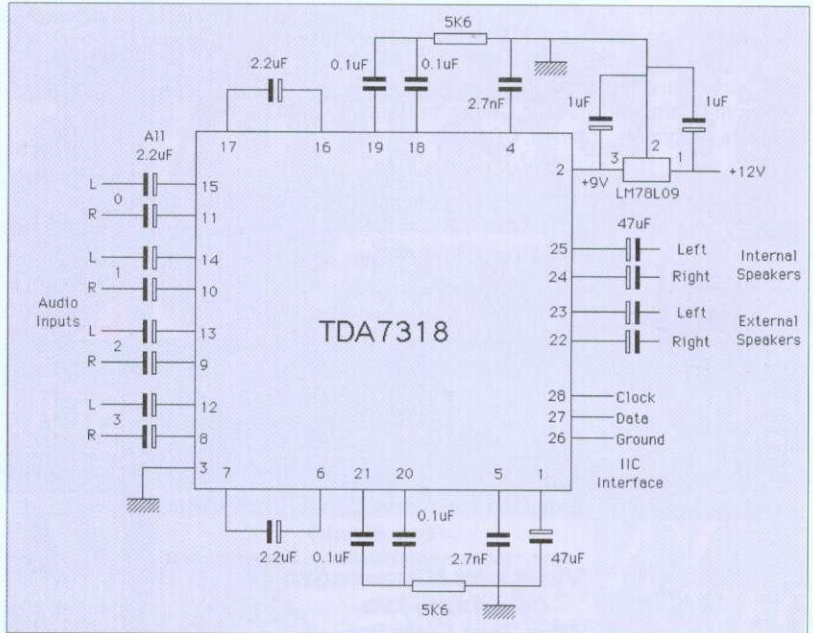

Figure II: The circuit of the Audio Switcher

them, which overrides any attenuation.

Finally I arranged the software so that all the settings would be remembered for each audio input selected and that those settings are stored every time the device is quit. You don't have to do anything to save the settings; the next time the application is opened you will get exactly the same results. The input labelling is done in the templates file and can be easily altered to suit your particular setup.

Now I wanted to be able to preset the audio on power up or when certain applications were run like the PC card or the CD player. In order to do this I have written a second small application - *!PresetAud* - to preset the controls. All you need to do is include an instruction to run this in the *!Run* file of your application. The settings are taken from a file called imaginatively 'Settings'. This can be obtained from inside the *!AudioSel* application once you have quit from it and can simply be dragged inside *!PresetAud*.

So now I have my sound system tidied up and I have one rather unexpected bonus. During the boot up sequence after a power on, the chip sets itself to zero volume so I have finally got rid of that intensely annoying beep - peace at last.

Table I: The register structure of the TDA7318

7	6	5	4	3	2	1	0	Function
0	0	A5	A4	A3	A2	A1	A0	Volume Control
1	1	0	A4	A3	A2	A1	A0	Left Rear Speaker
1	1	1	A4	A3	A2	A1	A0	Right Rear Speaker
1	0	0	A4	A3	A2	A1	A0	Left Front Speaker
1	0	1	A4	A3	A2	A1	A0	Right Front Speaker
0	1	0	G1	G0	0	S1	S0	Audio switch
0	1	1	0	B3	B2	B1	B0	Bass control
0	1	1	1	B3	B2	B1	B0	Treble control

Bits labelled A - 1.25dB per step
 Bits labelled B - 2.0dB per step range 0 to +/- 14dB
 Bits labelled G after inversion +6.25db per step
 Bits labelled S - input channel number

ACORN USER guide to local dealers

SURREY

 **Calancraft Ltd.** 
THE COMPLETE ACORN DEALER

- Showroom open 9.00 - 5.30 six days and to 8.00 on Thursday.
- Acorn range on display, and full demonstrations given.
- Lots of programs, games and education software for you to try.
- Full service and repair facilities.
- Network Dealer and Training Centre for Education and Home.
- Printers, Upgrades, Internet, CD ROM, etc. etc.

"Very helpful people"
 with a 13 year long reputation for exceptional service and support.

Easy parking.

196 High Road, Byfleet,
 Surrey KT14 7QT

Tel: (01932) 342137 Fax: (01932) 336435

EAST MIDLANDS

KEYBOARD TECHNOLOGY

ACORN Education Dealer
 ACORN Network Dealer
 ACORN Special Needs Centre

0% finance on Risc PC

Visit our Showroom just 1/2 mile from
 M1 junction24 (2nd right on A6 south)

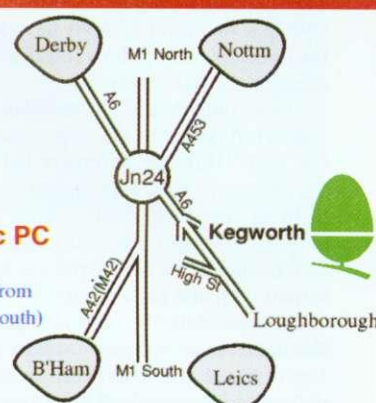

Keyboard Technology Ltd
 51 High Street Kegworth
 Derby DE74 2DA
Tel 01509 672222

Open Mon to Fri 9.00 - 6.00pm
 Saturday 9.00 - 5.00pm

WEST YORKSHIRE

THE CHOICE OF EXPERIENCE **For the best service in Yorkshire**
 (we think)

CALL US! for A7000, RisePC & Pocket Book II
Visit our Showroom

Open 9.30 to 5.30
 Mon, Tues, Weds, Sat.
 9.30 to 7.30
 Thurs & Fri.



Davyn Computer Services
 Printers, Ribbons, Ink Cartridges,
 Refills
 Expert Advice & After Sales Service
 Mail Order Master Card, Visa, Switch
 Ring for Prices
 Service & Repair to all Equipment
 Full Range of Acorn Hardware & Software
 (We operate the Acorn Finance Schemes)
 Full Range of Educational Software
 Tel. 01924 254800 Fax. 01924 258036
 e-mail sales@davyn.demon.co.uk

How to find us



SOUTH WALES

UNIQUEway

 SOUTH WALES' ONLY DEDICATED
 ACORN DEALER AND ACORN CENTRE
 OF TECHNOLOGY



**WE'VE MOVED TO BIGGER
 NEW PREMISES**

Technical Support - Repairs - Hire - Internet Connections
 Low cost finance available on all systems.

3 Clarendon Road, Cyncoed, Cardiff CF3 7JD
 Tel 01222-464020 Fax 01222-463325
<http://www.uniqueway.co.uk>

PLEASE NOTE OUR NEW ADDRESS AND PHONE NUMBER FROM 1st MAY 1996

MIDLANDS AND OXFORD

DAGO

459-465 Warwick Road, Tyseley, Birmingham B11 2JP
XEMPLAR EDUCATION AGENT
 Tel: 0121 706 8933 Fax: 0121 706 4306

- Home use
- Business
- Education
- Special Needs
- Software Training
- Acorn approved network installers
- Complete range of Acorn equipment
- Consultancy





XEMPLAR EDUCATION

For expert advice & friendly service come and see us.
 We are open
 Monday - Friday
 9.00am - 5.30pm

CUMBRIA

 **Cumbria Software Systems**
 Specialist Acorn Dealer

Risc PC700, A7000
 Sales, Repairs, Software, Peripherals

Network design and installation
Ethernet, Nexus ATM, Multi-platform networks

Semerc Authorised Dealer

CSS Ltd., Unit 3A, Townfoot Industrial Estate
 Brampton, Cumbria, CA8 1SW
Tel: 016977 3779

JACK KREINDLER

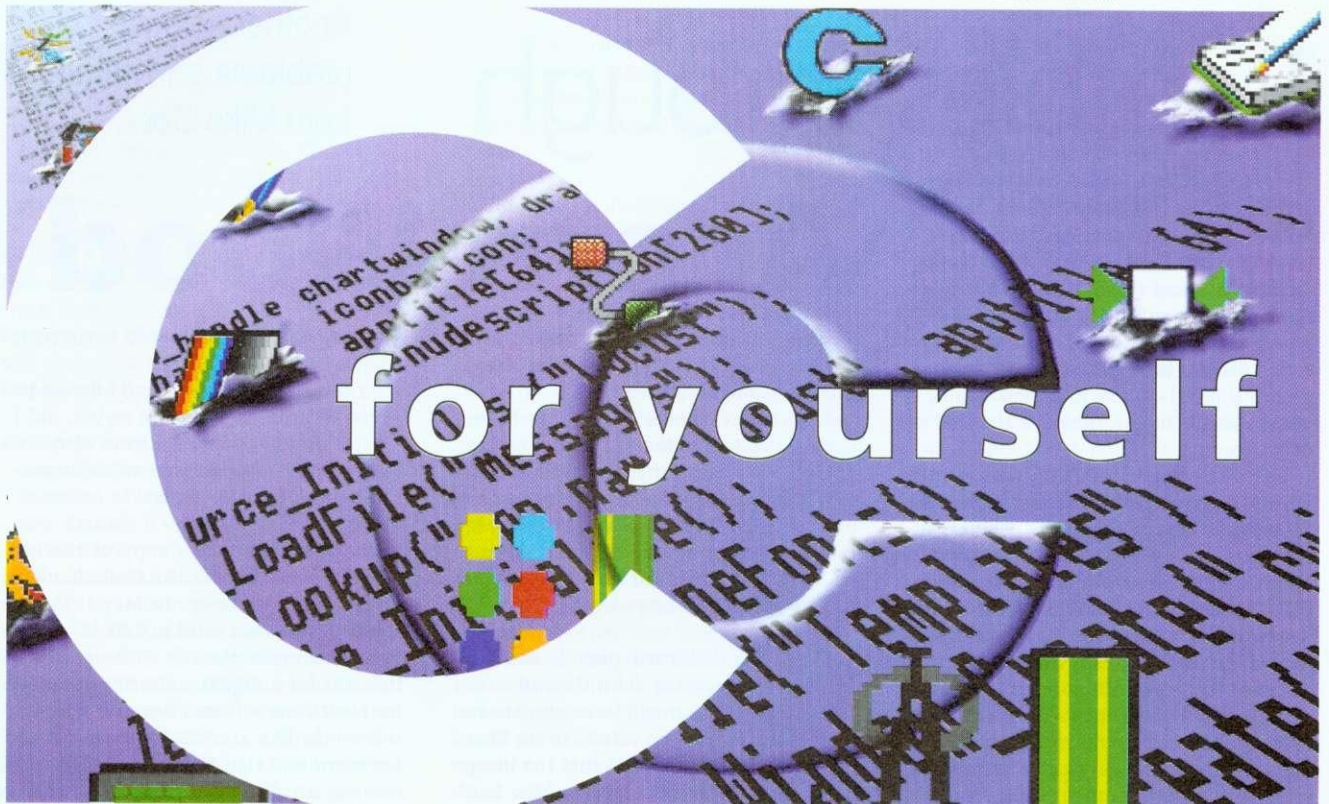

One of the crucial differences between RISC OS and the other graphical user interfaces that exist lies in the way that file transfer is accomplished – we take saving and loading data from applications, or even between programs, very much for granted. In Acornland, all we have to do is drag an icon – if we want to save or load something to or from disc, we use the standard filer windows. RAM transfer is equally simple – just drag the file over another icon on the icon bar.

We're lucky. On certain other platforms I could mention, each application ends up with its own file interface, needing a hefty amount of code and producing a situation where no two file transfer dialogue boxes are the same. The approach that Acorn followed means that the programmer just has to provide one or two functions and the WIMP will do most of the hard work – your program doesn't need to know the difference between a floppy disc, an IDE drive or a magneto-optical device; all it has to do is write data to a filename that the WIMP provides.

This month, I've included the preliminary tools necessary for file saving in the example application – loading it from the cover disc, opening the *Save* window and dragging the icon will provide you with a dotted box that you can happily move around the screen. That's all it does for now, but we'll get on to the actual task of saving soon.

In order to make an icon draggable using the *Acorn User* library, you should first set its icon button type to be 'click

Steve Mumford discovers that programming the WIMP's a drag

and drag' (type 6). Whenever the user tries to perform a drag operation on the icon now, your task is passed the number of the mouse button used (*Adjust* is 1, *Menu* is 2 and *Select* is 4) multiplied by 16, to indicate the fact that the icon is being dragged.

You should then listen out for any **Mouse_Click** events occurring within *Wimp_Poll* that match the appropriate window handle and icon number – all you need to do then is call **au_dragbox()** with the appropriate values. Everything else is taken care of – **AULib** interrogates the icon and its window to discover the exact position of its bounding box on screen, then **Wimp_DragBox** is called to handle the familiar rotating dashed line. Here's the snippet of code from the example application that starts the procedure, all within the **mouse_click()** function:

```
if ((au_bytetoword(poll_block,
12) == win_data[2].win_handle)
&& (clk == 4*16)) {
icon_num =
au_bytetoword(poll_block, 16);
if (icon_num == SAVE_ICON) {
au_dragbox(au_bytetoword(poll_
block, 12), icon_num);
}
}
```

The first line checks that we're dealing

with the correct window, and the drag operation has been started with *Select*. After that, we grab the target icon's number from the poll block and check it to see whether it's our save icon. If it is, we perform a function to start the usual drag box, and return to our polling loop.

After that, all we do is sit and wait for a **User_Drag_Box** event (type 7) to be reported to us via **Wimp_Poll** – this indicates that the dragging operation has finished and all buttons on the mouse have been released. At this stage in the procedure of saving a file, we would call **Wimp_GetPointerInfo** to discover which window the pointer was over at the moment when the drag operation ended.

From there, we can send a message to the Filer using that information and supplying a file name, type and approximate size – this allows the Filer to check whether the operation is feasible. Once our application receives a **DataSaveAck** message, we can get down to the low-level process of writing the file. The message-passing procedure might seem a little convoluted, but it means that saving between applications can be handled very simply using the **Wimp\$Scrap** directory.

Data loading follows the same general scheme, although we don't have to go to the trouble of drawing the drag box, as someone else will be doing that for us – again, we listen for **User_Drag_Box** and check to see whether the file was dropped on our icon bar icon. I'll fill in the code necessary for these functions next month.

Rambles through

Good news this month about my saga over my quad speed CD drive I bought from Yellowstone – it's finally working at quad speed. I received the correct driving software days after last month's copy was due in. I can now transfer a 10M file into RAM FS in 18 seconds, giving a speed of 555 K/second which is close enough to the theoretical speed of 600 K/second.

I've been experimenting this month with a digital signal processor starter kit from Texas Instruments. This is a neat little board with a processor, memory and 14-bit digital input/output, all for under £100. It uses the TMS320C5 processor and needs the PC card to run it. Digital signal processor or DSP chips are specifically designed to support the sorts of operations you need in digital filters and communications circuits. For example, you have registers that work in circular buffers and multiply and divide instructions.

It works, or should I say nearly works, on the PC card because it suffers from the occasional crash and the test programs sometimes report a fault with the serial communications. Now in my experience this is not uncommon with hardware designed to attach to the serial port. As well as my own experiences of this DSP board and a logic control programmer I have had reports of problems from two readers about radio communications interfaces.

From my investigations I think I know why this happens. PC software controlling hardware expects to be able to access the serial port and its data registers in a specific amount of time. Now while the PC card has a real processor on it, the RISC computer still has to emulate a normal PC's hardware. This is much slower than having the correct hardware and is known as the latency time.

While this is reasonably short for the serial data registers, it is comparatively long for the status registers. Hence a software program that uses the handshaking lines for data transfer or relies upon seeing how long a byte takes to turn around will think there is no hardware present. This can sometimes be solved by running at a lower baud rate but this is not always possible.

Therefore please use extreme caution when thinking about using the PC card with hardware; you could waste a lot of money. Your safest bet is to specify that you want a product to work with an Acorn Risc PC 486 card configuration when you order it, then you have a chance of some comeback. A final thought is that the

Acorn Wood

StrongARM chip might be so fast as to remove this problem – 'it's a slim chance Jim, but it might just work'.

Now I don't know if you buy lottery tickets, I certainly don't for many reasons, one of them being that the odds are way out. I have never benefited from any lottery funded projects but I might just. It has recently been announced that there is to be lottery funding for a British Millennium Satellite to be put into low Earth orbit.

The idea is that it will provide an educational resource for schools and other interested parties. It will transmit data and images as well as the results of on board experiments. It is planned that the images could be taken over any part of the Earth and stored for transmission when the satellite passes overhead. My interest of course will be in designing interface equipment for Acorn computers so we can share in the information.

A similar satellite was put up by the University of Surrey about 15 years ago but there was no funding for continued operations and the project eventually fizzled out. This is a trap the current project hopes to avoid. As yet the satellite hasn't even got a name and the organisers are still asking schools to submit an experiment idea to be built professionally. Launch is planned for 1999 and if you are interested contact: Millennium Satellite Centre Ltd., c/o Royal Grammar School, PO Box 289, Guildford GU1 3WY.

Sorry if you have tried to access my web site over the summer but the file server crashed and we lost everything. What is worse they changed the name so even when it got back up people were having difficulty getting it. You are best going through the alias of <http://physics.mmu.ac.uk/Physics/Acorn> and just a reminder that the capital letters are important.

On to the problems this month, Barney Livingston from Southampton writes:

I have a Star 'Concept Keyboard' for use with my BBC and which I would like to connect to my Risc PC in order to assist my mentally-handicapped sister. This could possibly be achieved through the printer port. The Concept Keyboard also has a 25-way D-type plug and the connections look quite similar to the printer port, so it should be quite simple. It is an

Another selection of problems and solutions from Mike Cook

A4 keyboard which has 128 touch pads arranged in a 16 by 8 grid.

I can program in BASIC, so I should be able to write any software myself, but I have lost the May 1995 issue of *Acorn User* which contained your article on programming the parallel port.

Barney also sent me a copy of the keyboards pinout, it looks like there should be no problems. However, the May 1995 issue is not the one you want to look at – rather you want to see the Feb 96 issue. I know this was for a digital voltmeter but please bear with me – I am assuming here that this works like a normal scanning matrix keyboard and that the values on the data outputs are constantly changing until a pad is touched. They will then freeze at that pads code and produce a strobe output.

What you need to do is to make up a wire to connect the data bits in your computer to that on your keypad; you will find the computer's pinout in the Welcome Guide. Next wire up the negative strobe on the keypad to the acknowledge line pin 10 of the computer and the system ground to pin 25 of the computer.

Next you have to power your keypad with 5 volts. This was available on the old BBC but not on the new machines. You can tap this voltage from inside the computer or get a separate supply. From the pinout I was sent, this goes to pin 25 of the keyboard. A point to note here: If the two connectors are the same you have to be careful not to get them the wrong way round, therefore you should label each end of the lead. Now you want the software to recognise the strobe as a signal to latched in data. This is where the DVM software comes in; it used the same technique. You should open a file which specifies the parallel port is used to be read by the line:

```
F%=OPENIN"parallel:"
SYS"Parallel Op",2,&20,&DF
```

After that you can use the BGET command to extract bytes from the keyboard. You can then interpret them how you like.

Barney also has a supplemental:

I want to upgrade my Risc OS 3.5 Risc PC's hard disc to 1GB. I have a limited budget and an IDE CD-ROM drive, so I can only upgrade my current hard disc. I

cannot afford a SCSI card, so I have decided to opt for splitting it into two 512Mb partitions. I have been told that I can do this with the software provided with the computer (possibly IForm). I would very much like to know if this is possible and if so, how?

As far as I know you can't generate a partition on an IDE drive. The Rapid IDE card from Yellowstone will allow you to do this, as will OS 3.6. I suspect that OS 3.7 will also allow this and it will probably be available by the time you read this.

Mr Barnett has a suggestion for an article:

I saw "It'll Never Work" and on it was an invention which I thought might interest you. Basically it was a device which measured the electrical activity of the brain via a headband. It then found the intensities of the brain's alpha, beta and gamma waves which it used for control purposes.

One example of its use was when they showed a screen containing two boxes labelled 'Switch 1' and 'Switch 2', and Jez Nelson managed to move a pointer over one of the boxes and click on it thus turning a light on and then off. It appears that the intensity of the alpha wave determined the x-coordinate, that of the beta wave the y and the gamma wave caused a click when it reached a threshold. How about trying this for an article?

This one brings back painful memories of 1972 when I constructed a very similar machine – the popular name for this was bio feedback. The idea was that I could use the brain waves and heart beats to generate music by feeding them into an arrangement of sample and hold circuits, voltage controlled oscillators and voltage controlled amplifiers.

The front panel was a huge patch bay where I could interconnect the amplifiers and oscillators. However, I found it impossible to detect any brain activity at all – some might say this is no surprise. The voltages I was picking up were due to minute muscle movement but there is worse to come. In order to get a good connection I had covered my electrodes in a conducting gel obtained from a nurse at the local hospital. Being a lone experimenter I was working on the circuit while wired up to this.

I found out the hard way – if I touched the output of the amplifier which was only carrying a few volts, this would get picked up by the electrodes on my body and cause a feedback circuit, which placed 15 volts across the head electrodes resulting in severe pain. The second time this happened I abandoned the project and I have never been keen to try this again. There is a cardiac monitor experiment on one of the instrumental courses I take and my students have great difficulty building

an amplifier that will pick up voltages from the heart. Again muscle movements are a problem – you have to breathe. So therefore, if you don't mind I'll pass on that one.

Philip Ludlam from Bracknell wants to know about the serial transfer. He writes:

My question concerns my BBC Master. I would like to transfer data/programs between that and another BBC B via the RS 423 interface. However I have run into a few problems. The two machines will not communicate, even on 75 baud. The Master appears to send information (after the first 255 characters have gone into the buffer the transfer slows down to about 1 per second when at 75 baud), but the BBC sends the first 255 characters and then halts.

I have checked the lead and it is fine – the connections match and I have managed to transfer data between two BBC Bs, but not between the second B and the Master. I think there's a problem at the Master's end – is it something the do with the *FX calls or configuration? How easily can I transfer files between a A3010 and a PC via the serial link? Is it just a lead or do the two machines use different interfaces? What type of lead/interface would I need?

Communicating through the serial port should be simple, but sadly many times it is not. With only a few wires to play with it is surprising how often it can go wrong. There is nothing much different about the Master than the Model B so it has to be the lead. This applies even to the more modern machines. If a buffer fills up and then freezes, the CTS handshaking line is at the wrong state. This should be wired to the RTS line of the other machine.

Remember on these old machines, just to complicate things, you could plug the serial lead in two ways. The best way to set about serial communications is to just wire up the data lines, data in on one machine to data out on the other. Next, make sure the baud rates are the same on each machine by using *FX7,4 and *FX8,4, and finally, make the word format match to 8 data 2 stop by using *FX156,&F3,&E3. Then issue a *FX3,1 on the sending machine and *FX2,2 on the receiving machine and then on type the sending machine until it freezes. Then you can see which handshaking wire you need to connect to what, as when you get it right the computer unfreezes. Then by typing *FX2,1 on the receiving machine you should be able to get one machine controlled by the other.

The same techniques can apply when using a PC but remember the PC doesn't have any useful *FX commands. The simplest way is to get hold of some simple communications software and use that, as

the interface is the same on both machines.

Philip also has two supplementals:

On another note how can I get hold of a leads (from an A3010) and drivers for an Olivetti PC Printer tJP 250) and an Epson LX-850? Secondly, I am going to purchase an A3010 (my first Archimedes). Please explain to me the differences in monitors, as I can only relate to the resolution and maximum number of colours. I am completely baffled by jargon such as AKF 50/53/60/85/95. What are Multi-Sync monitors? What is 0.28dp? Is it the same as .28 dot? How about .26 and .25 dot? What's the difference between AKF monitors, Microvitec and Iiyama? What effect does 14in, 15in and 17in have on the display?

For leads and drivers contact your local dealer or phone around any of the hardware suppliers who advertise in this magazine. As to monitors, it's fairly straightforward when you strip away the jargon. Originally monitors worked on the same standard as a TV set. That is, it took about 64 uS for the spot to travel left to right and 25 mS to travel top to bottom. The monitor was synchronised to the computer using pulse called sync pulses. This standard fixes the number of lines in the Y direction you can have.

There are two things wrong with this when it comes to modern computers. First there are not enough lines for the resolution you want and secondly it's not fast enough to avoid flicker as you are normally viewing a monitor from much closer than a TV set. To address this, computers were made that produced sync pulses at different rates and so the monitor had to be capable of latching onto these pulses hence the name multi sync monitors.

The numbers after the AKF indicate what refresh rate the monitor can use. That is how many times a second the monitor redraws the display. The old TV system had a new screen 50 times a second, from the numbers quoted the monitor can also refresh at up to 95 times a second. The dp (dot pitch) and dot specification mean exactly the same thing, how far the phosphor dots on the screen are apart in mm. The smaller this number the higher resolution you can get on the screen and the crisper it will appear.

As to a 14in display, this is (or should be) the size of the diagonal of the screen; the bigger the number the bigger the picture you will see. This has a knock on effect on the resolution you can see with the same size dot pitch, the bigger the screen the more pixels you can clearly display. Finally AKF is simply the model numbers given by one manufacturer and the other names are other manufacturers.

Subscribe now to claim your free gift or special offer from

ACORN USER

the world's number 1 Acorn magazine

You already know what a great magazine ACORN USER is. After all, we've been the main source of information for all Acorn enthusiasts for the past 13 years.

What you might not know is that by taking out a subscription today, not only are you guaranteed never to miss an issue of the biggest and best Acorn magazine in the world, but you can also claim an excellent free gift or special offer, available exclusively to all new ACORN USER subscribers.

As an Acorn User subscriber you'll benefit from:

- Free delivery, every issue, direct to your home
- One of our amazing free gifts or special offers

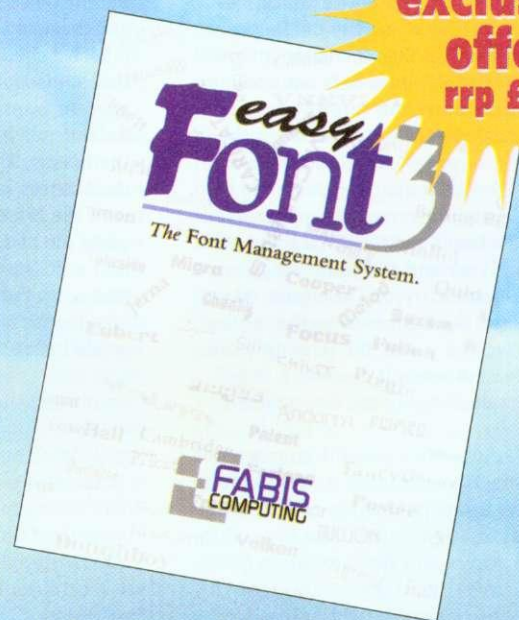

BINDER & TWO FREE MAGAZINES



Exclusive to Acorn User this binder will hold up to 13 issues of your favourite magazine. PLUS receive an extra two magazines absolutely FREE!

EASYFONT 3

Gives flexible control over your fonts; WYSIWYG display window; up to 40% space saving on your hard drive; specifically designed Font Filing System giving maximum power and flexibility; the ability to create countless new styles quickly and easily; and the elimination of the dreaded 'Font not found' errors.

SUBSCRIBING HAS NEVER BEEN EASIER

DIRECT Debit Why not make your subscription even easier and subscribe by direct debit, spreading the cost of your subscription over quarterly hassle-free payments. What's more, you need never worry about missing an issue again, as the subscription continues until you decide to cancel.

FREE



STAR FIGHTER 3000
SAVE £29.95

Winner of our reader's Best Game award. An original and thrilling space game from Fednet.

Only £10

PUBLISH ART
SAVE £25.00

The ultimate DTP resource – 1500 original designs, a massive 13Mb of eye catching resources – for perfect DTP

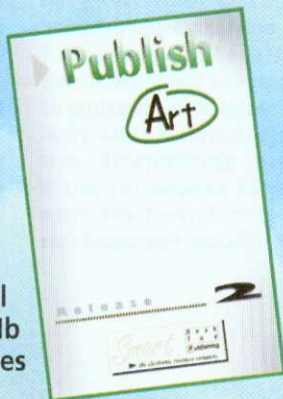

FREE

4 DISC GIFT PACK

Four high density discs (low density also available). Including a collection of education resources, a multimedia presentation detailing the top 10 programs released this year and the best PD and Shareware available.

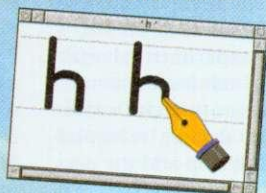
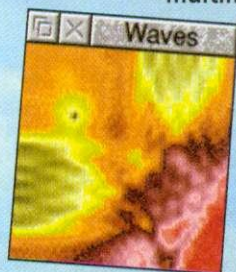

Subscription Hotline numbers

Tel:

0151-357 1275

Fax:

0151-357 2813

Email:

database@dbdirect.demon.co.uk

Yes! I will subscribe...

1a Take advantage of one of these offers TODAY before we change our minds! See section 2

4234 UK £39.99 4202 EU £53.99 4203 World £68.99*

To renew subscription please tick:

4235 UK £39.99 4224 EU £53.99 4225 World £68.99*

*Unfortunately World subscribers are not eligible to receive the free gift/special offer

I wish to pay by: Cheque/postal order made payable to IDG Media
 Credit card (Visa/Access/Barclaycard/Mastercard/Eurocard/Connect)

Expiry date /

Card No.

1b Please enrol me as a subscriber to Acorn User.

4210 with payments of £9.49 by continuous quarterly direct debit

See section 2.

Your subscription will continue until you cancel. Over a year you will receive 13 issues.

Name of Bank/Building Society

Address

Name of Account

Your Account No. Sort Code

Date Signature(s)

Your instructions to the bank/building society:

Originator's ID No. 851412

I instruct you to pay direct debits from my account at the request of IDG Media. The amounts are variable and may be debited on various dates. No acknowledgement required. I understand that IDG Media may change the amounts and dates only after giving me prior notice. I will inform the bank/building society in writing if I wish to cancel this instruction. I understand that if any direct debit is paid which breaks the terms of the instruction, the bank/building society will make a refund. Bank/building society may decline to accept instructions to pay direct debit from some types of accounts.

2 Please send me the following FREE Gift/Special Offer (tick one):

- 4205 Binder and two magazines **FREE** 4208 Acorn User Gift Pack **FREE**
4206 Starfighter 3000 **FREE** 4731 EasyFont 3 **Only £10**
4207 Publish Art **Only £10**

For the gift pack please specify whether you require High or Low density discs (delete as appropriate)

3 Name (Mr/Mrs/Ms/Miss)

Address

Postcode Tel

4 Now send your completed form and payment to Acorn User, Database Direct, FREEPOST, South Wirral L65 3EB. Tel: 0151-357 1275. Please state if credit card billing address is different from the delivery address. Photocopies or handwritten versions of the above information are acceptable.



Re: Bare boards please (June 1996)

In (a slightly late!) response to Christophe Pouet's letter in the June 1996 edition of *Acorn User*, it is indeed possible to buy 'spares' from Acorn - it always has been.

I have a list in front of me: case mouldings, springs, hinges, floppy drives, packaging(!), gaskets, switches,

motherboards, processor cards and sometimes you can even buy the RISC OS ROMs (3.50 chips are about £10 each - I don't know about others).

It is Acorn Computers who deal with such orders. If you have a credit account (i.e. are a dealer) you can order direct. Enthusiasts must order through their dealer.

If Mr Pouet is looking for

RISC OS 3.6, many folk will have such chips for sale in September when they fit 3.7 chips and their StrongARMS.

**Richard Walker,
Stockton-on-Tees**

Re: Proper decimal points

I have only just read your June 1996 issue letters page and having made some use of the Alt+keypad combination of late to put symbols into engineering drawings, I was interested to read the letter from D A Cox. I recently bought *Ovation Pro*, and I can

DIY CD-ROM drive

I'm sure that many of your readers must have old external 5.25in disc drives left over from their old Beeb days, which probably haven't been used since they transferred files over to their new Archimedes. Here's what I've done with mine:

For some time, I'd wanted to have a CD-ROM drive, but was put off by the high prices quoted by Acorn dealers. I then saw that many PC suppliers were selling Hitachi CDR-7730 IDE Quad

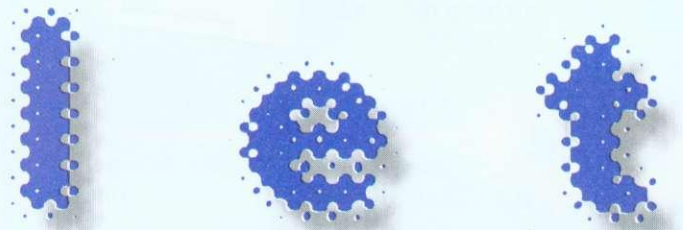

assure Mr. Cox that the facility is already there to redefine the decimal tab as ASCII 183.

Having experimented with the decimal tab for a few minutes it looks as though *Ovation Pro* will, by default, recognise both the full stop and the decimal point (183). An unexpected feature of the decimal tab is that when typing in letters these are entered to the left of the tab and the point does not stop this action but the full stop does.

For all those eager to use sexed quotes and proper decimal points, do rush out and buy *Ovation Pro*. It is the sort of software to make you proud to own an Acorn machine.

**David Lewin,
DavidLewin@aol.com**

speed bare drives for as little as £35 + VAT. I bought one of these, removed the 5.25in disc drive from its case, and fitted the CD-ROM drive in its place. All of the fixing screw holes lined up, and even the power connector was the same.

The next step was to get an interface from Pyramid Computer Services for £28 + VAT, connect everything together, and it worked! A CD-ROM drive and interface for a total outlay of £109.28, which is a huge saving compared with dealer prices for external CD-ROM drives.

I hope this is of benefit to your readers.

**Mark Wiggin,
Newport, Shropshire**



Branching out

I am a recent convert to the computer world and I started with the Risc PC 600 (against my son's advice), mainly because of the promised PC capability. This has partly been fulfilled but with a few 'features' I hope will be ironed out mainly to do with the serial ports.

My reason for writing is that I find it hard to get coherent information about upgrades available. Both on the hardware route and the software connected with the upgrades.

are available according to need.

Mainly because of the queue and time available I did not join the Clan at the first Wembley show after the PC 600 launch. This was a mistake as far as getting information is concerned. For some reason the dealer I bought the machine from did not seem to get any information. (They went in the night of the long knives.) I then, via Acorn, was directed to another dealer who, like the first, was extremely pleasant but I think geared totally to the

been. I have a system called *Modemaster* that runs under DOS to decode weather, faxes etc. It depends on a decoder fed from a communications receiver into the serial port. Mike made great efforts to find out more about it, but, in spite of his contacts and very wide experience - I find his range of articles most impressive - has not been completely able to explain the problem. Probably my lack of understanding of the explanation.

It is rather galling as the system will work well on a very old Compaq, literally

Windows on PCem?

It said on the October 1996 letters page that Windows 3.11 will run on the *!PCem* software. I have the MS-DOS 6.22 and Windows 3.1 discs and successfully installed MS-DOS 6.22 which is working fine. I am having problems with installing Windows 3.1 though. I get the message 'Undefined opcode error - system halted'.

When I type:

a: setup.exe

I get the message 'Program too big to fit in memory'. The same happens when I do this from Windows 3.0. Are you sure Windows 3.1/3.11 can be run on an A5000 with 4Mb of RAM.

Simon Wilson,
101702.1034@
copuserve.com

While it's difficult to spot all the things that can be wrong - PCs being flakey at best and the old !PCem is not the stablest of programs - but I would say the problem here is that you haven't allocated enough memory for the emulator itself.

How do you run Windows in the PC Emulator? On my system all I get is 'Windows requires an 286 or higher'.

Alisdair McDiarmid,
a.mcdiarmid
@zetnet.co.uk

The !PCem software emulates an "80186" processor - not that there really was any such beastie - which is why it doesn't like it. I believe you may have rather an old version there and upgrading to a later emulator version might help. Beyond that you'll just have to buy a PC card.

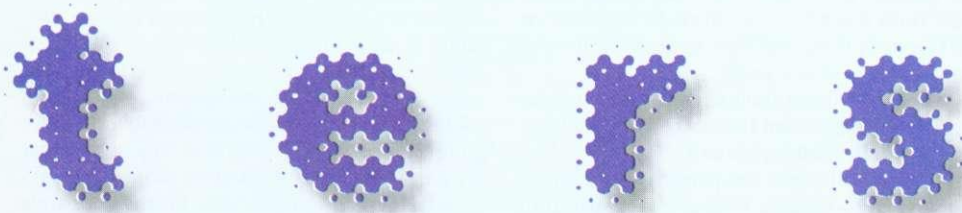

For example, I have tried hard to find out what and how one can use the seven 'slices' of capacity advertised as available with the basic machine. I asked five people at the Acorn stand at Wembley and none could tell me. Obviously I got the wrong people but I can find nothing in the literature I can get. Even more with the RISC OS software developments, the PC card advances and processors up to StrongARM.

I feel sure that there would be interest in an article that drew a tree with the PC 600 as the base and branched out showing the different routes for upgrades for the Risc PC series that

school market and not interested in anyone who wants to dive a little deeper. I have since joined the Clan and get more information, but there are huge gaps in my knowledge about the progress from the PC600 to 700 and now the StrongARM processor.

I freely admit that if I had been more experienced I might have been able to follow events in the magazines but even going back through the journals I have, I cannot find a coherent pattern in references to upgrading. Acorn themselves have nothing in handbooks that I can get out of them.

I would like to mention how helpful Mike Cook has

saved from a dustbin. While my expensive PC600 sits helpless.

John S Bennett,
Boston, Lincolnshire

I think the upgrade problem is that there is no upgrade path, even with processors - apart from get the latest. The seven Risc PC slices can be filled with whatever you find to fill them with, be it additional hard disc drives, CD-Rom drives or computer-controlled toaster. If you don't know what you want to put into the additional slices then you probably don't need them, 99.99 per cent of people don't get beyond two slices.



The Regan files

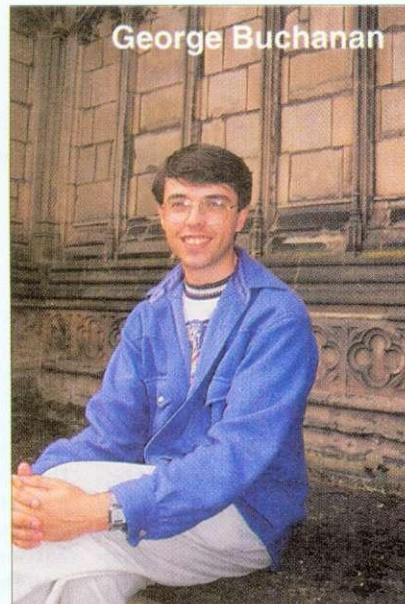

It is very easy to write something which has lots of features but is a curse to use, or something which does nothing but is easy

When George Buchanan – the force behind Dalriada Data Technologies – was doing his sandwich year at college, he worked at a seat belt manufacturer. It was July and the plant was nearly shut down as everyone was off on holiday.

Then the phone call came – a manufacturing plant in Europe wanted to know when its next consignment of seat belts was arriving. No one had thought to tell them that the factory effectively shuts down for three weeks in the summer; the European plant was looking straight at three weeks of no work as a result.

George tried to get hold of the bosses, and the personnel manager, but they were all on holiday. Thankfully, he used his initiative:

'Fortunately I knew the personnel system on the computer – because I wrote it. I managed to get the employee list and get in enough people to run one line, and a foreman. It was funny because I had to phone people up and tell them that I didn't know how much they were going to get paid but that I would do my best for them. We did produce enough to tide them over. Imagine it – there was this lad on 7.5k a year running a plant which costs 1.5 million pounds a day to run.'

In other words, George improvises well.

George originally wanted to be a historian, but this changed overnight when he fell upon a book called *Number Predictions and War*. This explains that you can predict the outcome of battles based on historical information, and lots of number crunching.

'I played around on my father's machine, figuring out how to list the programs which were written in BASIC, and from that I learned to program. I changed from a completely arty history student to a rabid mathmo. At school I wrote programs for the BBC which they needed for administration; I was lucky because my teacher encouraged us to write proper programs, not the usual *10 HELLO WORLD, 20 GOTO 10*.'

Proper programs indeed; by the age of 16 he was writing costing systems for Northern Ireland's largest chain of supermarkets, working for printers and doing security systems for banks

like Ulster Bank: 'These were nice little earners on the side'. Then came Dalriada.

'At the time people were into naming their companies after Greek and Roman gods and goddesses, so I thought: "Forget that, let's go for a Celtic one," hence Dalriada. Dalriada was in fact an Irish/Scottish kingdom which was supposed to exist from the 4th century AD to 1200 AD'.

'I think you will find that a lot of other companies who set up in the Acorn market the same time as us have gone. This is mainly because they chose to do something which had already been done. *TableMate* was born because I had been using *Impression* a lot and basically *Impression's* tabling was a nightmare. *GraphMate* does have competitors, so it was of utmost importance that we did it differently from other people. The days of re-selling a word processor for the 20th time are over.'

'My philosophy is that just because a program might be used by a 10-year-old who does not want to worry about a GIF file, does not mean you have to compromise professionalism. If you think of a graph, the Y axis is how many things you can do and the X axis is how hard it is to use. It is very easy to write something which has lots of features but is a curse to use, or something which does nothing but is easy. There is a straight line between the two axes and you should curve that out and so get as much as possible for very little work.

'I think the industry as a whole is at a crossroads, and what I do wish is that more Acorn users realised that the changes going on in the Acorn world are similar to those in the PC world. Development of all the major programs has slowed down. What we have to do is plough our own furrows, not be a poor-man's PC.

'There is going to be an Acorn future: it won't be the same as the past. The changes which are going on – the formation of ART and Xemplar – are making RISC OS like more of a building block.'

In a changing Acorn market, improvising to cope with changed circumstances is an important skill, and George does it better than most.

Jill Regan AU

SCSI: SCSI 1. Studio24. Pictures. Walter Biker (RGB) at 3

Studio24 was hailed as one of the best 24 bit painting programs. A completely new program, Studio24Pro is now set to lead the field in painting & photo-retouching

Picture produced by Walter Briggs, Kingfisher Graphics using Studio24Pro

- ### Features
- * Fast Virtual Memory
 - * Random mutated texture generation
 - * Undo brush, Texture and Filter brush
 - * Over 40 pre-defined filters including Spin blur, Motion blur, Lighting etc. etc.
 - * PhotoCD and Scanner input
 - * Merging of Sprites, Jpegs, Tiffs & Draw files.
 - * Built in Draw file creation
 - * RGB, CMYK or Indexed channel modes
 - * Up to 16, 8 bit mask channels
 - * Filter preview window (shown above left)

Many Acorn User front covers have been created from scratch using this program alone, concrete proof of the power of this creative tool'. - **Acorn User March 96**

Studio24Pro

£149.87 inc vat

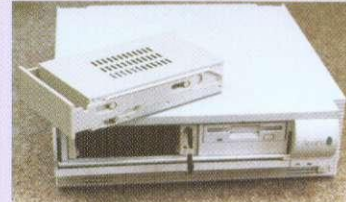

Removable Harddrive System

Total Data Security & Harddisc Backup

The removable harddrive system fits into a 5 1/4" drive slot in the RiscPC and harddrives are available in many sizes which can simply plug in and out of the slot as required. The drive may be locked in place to prevent unauthorized removal. For total security the drive may be removed and stored in a safe place to prevent unauthorized access to your data. Because the removable drives are available in any size (up to at least 4Gb) they are also ideal for use as backups for existing harddrives, and may be easily transported between different computers for rapid transfer of large datafiles. The system is available for use with both IDE and SCSI filing systems. External boxes are available to enable SCSI removable drives to be used with older Acorn models. Please phone for details. See opposite for prices.



PAL TV Coders

The PLC/3 PAL TV Coder works in any of the 'Standard' Modes, e.g. mode12 and 15 on all Acorn computer models. The PLC/3 has a 15 pin RGB output for the monitor, a BNC for video and an S-VHS connector for S-Video. The PLC/3 will work with RiscPC computers although the AKF60, AKF85 and AKF90 will not work at the same time.



The AVK/3 will work with all computer models in all screen modes up to 800 x 600 resolution in 16 million colours. It has a remote control with facilities for zooming, freezing & panning the TV picture. Ideal for lectures and demonstrations etc. The AVK/3 includes all connecting cables including a SCART which gives TV frequency RGB O/P for large screen TV's, a phono socket for composite video and an S-VHS socket for S-Video.



ArtWorks Video Tutorial

A Brand new product from Pineapple is this VHS Video Tutorial covering the use of ArtWorks. Walter Briggs is the tutor for this 1 hour video which shows how to use all the ArtWorks tools and then goes on to show how Walter produced his famous Tiger head picture. Walter also draws an impressive landscape picture which can be copied by those with no artistic talent at all!

ArtWorks Video Tutorial £19.99

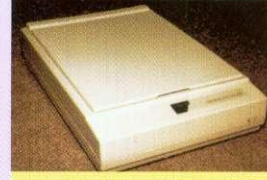

24 Bit Colour Scanners

Pineapple can offer a wide range of Flatbed A4 colour scanners starting from as low as £359 including software and VAT! The Epson range is currently the most popular although Canon are expected to release a new scanner to replace their IX-4015 shortly. The cheapest in the Epson range is the GT5000 with an optical resolution of 300dpi. This is adequate for virtually all home use. The GT5000 is available with either a parallel or a SCSI interface. The GT8500 has an optical resolution of 400dpi and comes with both parallel and SCSI interfaces. Finally, the GT9000 is the top of the range with an optical resolution of 600dpi and both parallel and SCSI interfaces. Imagemaster and Twain software are included in the price, but we also offer our Studio24Pro Photo retouching software at just £80.00 inc vat with every scanner purchase.

20 : 20 Finance available on all RiscPC's Studio24Pro at just £49.00 with any RiscPC purchase Studio24Pro at just £80.00 with any colour scanner FREE membership of the Virus Protection Scheme with any RiscPC

Virus Protection

The Pineapple Virus Protection Scheme will allow you to detect and remove over 100 viruses from your Acorn computer.

'If you're interested in virus protection, join the Pineapple virus protection scheme and buy Killer. Accept no alternatives.' - **Acorn User Feb 96**



Multimedia Speakers

Yamaha 10 Watt YST-M15 £63.00

A4 Colour Scanners

Primax Flatbed A4	£359
Epson GT5000 (parallel)	£425
Epson GT5000 (SCSI)	£499
Epson GT8500	£569
Epson GT9000	£699

All scanners include Imagemaster & Twain. Studio24Pro at just £80.00

A7000 Computers

4Mb HD540 14" Mon	£1069
4Mb HD540 CD 14" Mon	£1159

RiscPC 600 Computers

4Mb HD540 14" Mon	£1275
4Mb HD540 CD 14" Mon	£1375
4Mb HD540 17" Mon	£1675
4Mb HD540 CD 17" Mon	£1775

RiscPC 700 Computers

5Mb HD540 14" Mon	£1525
5Mb HD540 17" Mon	£1900
5Mb HD540 CD 14" Mon	£1600
5Mb HD540 CD 17" Mon	£2025
10Mb HD1Gb 14" Mon	£1750
10Mb HD1Gb 17" Mon	£2100
10Mb HD1Gb CD 14" Mon	£1850
10Mb HD1Gb CD 17" Mon	£2250

PC Cards

SXL-33 Card	Separately £233.83	with RiscPC £116.32
DX2-66 Card	£289.00	£169.00
DX4-100 Card	£349.00	£229.00
586-100 Card	£468.83	£351.32

CDRom Drives

x8 Speed CDRom £120.00

Memory Upgrades

1Mb to 2Mb Vram upgrade	£116.32
1Mb Vram	£145.00
2Mb Vram	£233.83
4Mb SIMM Ram	£ 23.50
8Mb SIMM Ram	£ 44.06
16Mb SIMM Ram	£ 88.99
32Mb SIMM Ram	£178.99
RiscPC Sound Card	£70.44

Phone for latest SIMM prices !!

All our prices INCLUDE 17.5% vat & delivery!

Printers



Citizen Printiva 600C

Citizen PRINTIVA 600C £399.00

Hewlett Packard

Laserjet 5L 4ppm	£399.00
Deskjet 600	£215.00
Deskjet 660 colour	£315.00
Deskjet 850 colour	£415.00

Canon

BJC610E col 720dpi	£415.00
BJC4000 colour	£276.00
BJC4100 col 720dpi	£276.00
BJC200 mono	£205.00
BJC210 (col option)	£222.00
B.J30 360 x 360	£165.00

Epson

Stylus Colour II	£329.00
Stylus Colour IIS	£244.00
Stylus Pro XL+ (A3)	£1079.00

3.5" Bare Harddrives

540Mb IDE	£125.00
850Mb IDE	£139.00
1.2Gb IDE	£165.00
1.0Gb SCSI	£225.00
2.0Gb SCSI	£370.00
4.2Gb SCSI	£665.00

Removable Harddrives

IDE Mounting Kit	£ 25.00
540Mb IDE	£145.00
850Mb IDE	£159.00
1.2Gb IDE	£185.00
SCSI Mounting Kit	£ 29.00
1.0Gb SCSI	£235.00
2.0Gb SCSI	£390.00
4.2Gb SCSI	£685.00
External Mounting Box	£ 89.00

SCSI Systems

SCSI Card	£116.32
SCSI Internal Cable	£ 9.99
SCSI External Cable	£ 19.99
SCSI II Card	£189.00
SCSI II Internal Cable	£ 9.99
SCSI II External Cable	£ 22.32

Monitors

14" 0.28mm SVGA	£199.00
15" 0.28mm SVGA	£299.00
17" 65Khz SVGA	£525.00
17" 82Khz SVGA	£599.00
20" 82Khz SVGA	£1115.00

Iiyama Visionmaster

17" 0.26mm MF8617E	£635.00
17" 0.25mm MF9017E	£699.00

!! Special RiscPC offer !!

A Eight speed CDRom drive for just £75 with any RiscPC

Pineapple Software
 Suites 13 & 14
 South Park Business Centre
 310 Green Lane, Ilford
 Essex IG1 1XT
 Tel 0181 599 1476 Fax 0181 598 2343
 email:- sales@pineapple.demon.co.uk

Terms:- All prices include 17.5% vat. Carriage FREE to mainland U.K. Phone for quote outside U.K. Official orders, cheques and all major credit cards accepted. Money back guarantee on all products.

'Pineapple offer some of the finest and friendliest after-sales support you will find' - **Acorn User Mar 96**

Why not come and visit us (easy parking) where you can see most of the Acorn range of computers and other hardware in action.
 Monday - Friday 0900 - 1730



There are two ways to get on the Internet:

Manual

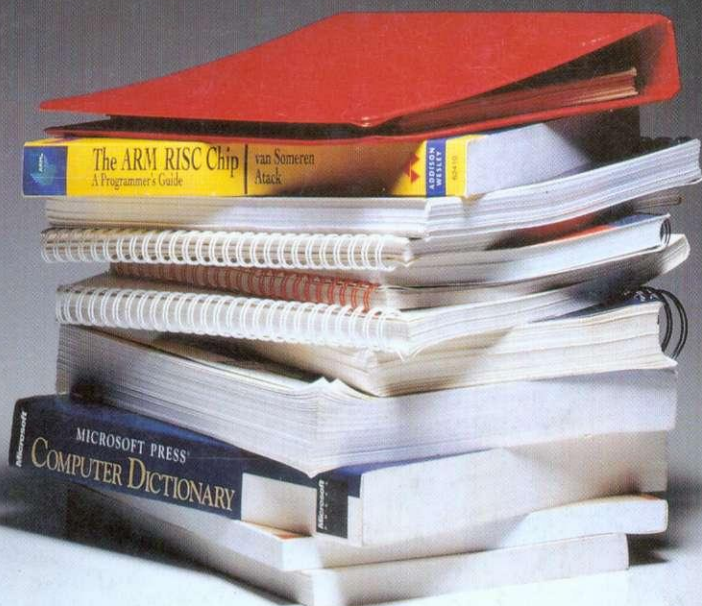

Automatic



TCP/IP, PPP, SLIP, SMTP, POP2, POP3, IMAP, MIME, UUencode, FTP, HTTP, HTML 3.2, NNTP, GIF, JPEG, Telnet, Gopher and more.

If the Internet is a superhighway, the directions can be pretty confusing.

When you use the ANT Internet Suite Release II, you don't need to worry about all the technical jargon. Our software takes care of setup and configuration. All that most users need do is put our disc in the floppy drive, type in name and serial number, and choose their Internet provider and access point from pop up lists.

The new version includes some of the most powerful and up-to-date Internet software available for Acorn computers such as our Web

browser Fresco® (also used in Network Computers), so you won't be left in the slow lane as new Internet technologies emerge.

So you can sit back and enjoy the ride. And if you do experience any difficulties, our dedicated customer support team won't leave you stranded on the roadside.

For further details, get motoring and contact ANT at PO Box 300, Cambridge, CB1 2EG, or visit our Web site at <http://www.ant.co.uk>



The ANT Internet Suite is £99 + VAT. If you use another commercial Internet product for RISC OS we'd like you to try the Suite for £49 (inclusive) plus proof of ownership. Upgrades from release I are £10 (inclusive).