



ACORN COMPUTER

BITSTIK USER GUIDE



ACORN BITSTIK GRAPHICS SYSTEM

USER GUIDE

Part No. 434000 / Issue 2 / 01.04.84

• Copyright Acorn Computers Limited and Robocom Limited 1983

Neither the whole or any part of the information contained in, or the product described in, this manual may be adapted or reproduced in any material form except with the prior written approval of Acorn Computers Limited (Acorn Computers).

The product described in this manual and products for use with it, are subject to continuous development and improvement. All information of a technical nature and particulars of the product and its use (including the the information and particulars in this manual) are given by Acorn Computers in good faith. However, it is acknowledged there may be errors in this manual. A list of details of any amendments or revisions to this manual can be obtained upon request from Acorn Computers Technical Enquiries. Acorn Computers welcome comments and suggestions relating to the product and this manual.

All correspondence should be addressed to:-

Technical Enquiries
Acorn Computers Limited
Fulbourn Road
Cherry Hinton
Cambridge
CB1 4JN

All maintenance and service on the product must be carried out by Acorn Computers authorised dealers. Acorn Computers can accept no liability whatsoever for any loss or damage caused by service or maintenance by unauthorised personnel. This manual is intended only to assist the reader in the use of the product, and therefore Acorn Computers shall not be liable for any loss or damage whatsoever arising from the use of any information or particulars in, or any error or omission in, this manual, or any incorrect use of the product.

User Guide prepared and edited by Systems Consultation Services.

THE ACORN BITSTIK GRAPHICS SYSTEM

- A Professional Computerised Graphics System

This computer graphics system is a great step forward in the application of microcomputer technology to graphical tasks.

Installed on the BBC Microcomputer, whether for general use in business and education or dedicated to technical graphics, this system provides facilities previously available only with the most expensive COMPUTER-AIDED DESIGN Systems on the market.

In potential, it is one of the most powerful microcomputer systems, and certainly the most fascinating. It is productive, easy to learn, and very fast.

The system will save time, expense and sheer effort wherever there is a need for graphical material. With this system, the design engineer, architect, draftsman, teacher or illustrator can focus on the creative task and leave the chores of drawing to the computer.

No computer knowledge is needed to learn the system. The drafting instrument, a purpose designed joystick, serves as drawing instrument and gives commands to the system. Minimal use is made of the computer keyboard. With the system, line perfect drawings can be created within an hour of installation.

It is also only a beginning, the core of a developing system which can be added to as your needs dictate. Whatever your graphical or design speciality, the system can be tailored to your needs by the creation of Libraries of your most frequently used symbols and constructs.

Here is a sample of what can be done !

Create a design- modify it anytime

Draw straight lines, arcs, circles
colour fill, erase, re-position again
and again, then add text
All without touching a pencil !

Store the Drawing

When the drawing is complete save it just as if in a filing cabinet. Retrieve it for use anytime - next day, next year The drawing remains available until erased.

Make prints as you need them

When hard copy is required, permanently record your creations with a printer.

C O N T E N T S

SECTION ONE - INSTALLATION

Section		Page
1.0	Introduction	1
1.1	System Components	1
	Minimum equipment needed	1
	Additional equipment available	2
1.2	Getting Started	2
	Installing the Controller	2
	Installing the Graphics ROM	2
	Checking the Installation	3
	Software and Disk Volumes	3
	Starting the System	4

SECTION TWO - TUTORIAL SECTION

Section		Page
2.0	Introduction	6
2.1	Tutorial 1	7
	Starting the Tutorials	7
	The Controller and Controller Commands	7
	On the Screen	9
	Making Menu Selections	10
	Making Palette Selections	12
	Changing the Library Drive	14
2.2	Tutorial 2	15
	Draw	15
	Erase	16
	Page	17
	Wipe	17
	Library Disks and Library Index	18
	Filing a Drawing into a Library	20
	Copying a Drawing back from a Library	21
	Erasing Copied Library Units	24
2.3	Tutorial 3	26
	Circles	26
	Ellipses	28
	Line Colour	29
	Line Type	31
	Paint	32
	Animation	33
	Finding a point	34
2.4	Tutorial 4	36
	Tangent Arcs	36
	Tangent Arcs and Lines	39
	Compass Arcs	41

C O N T E N T S

2.5	Tutorial 5 44 Nib Drawing 44 Angled Nib 46 Nib with Spacing 47 Tracing 50 Freehand Drawing 51 Text - Direct Entry 51 Text - Copying from Library 55	
2.6	Tutorial 6 57 Zoom 57 Zoom and Pan 58 Zoom with Library Units 61 Reverse Zoom 64 Zoom Stores 64 Mirror Images 67 Changing Colour of Library Units 68 Changing Line Type of Library Units 69	
2.7	Tutorial 7 71 Move 71 Duplicate 73 Exchange 74 Modifying a Library Unit 76 Modifying a Work Page Unit 77 Exchange - Single Library Units 80 Exchange - Global Exchange of a Unit 81	
2.8	Tutorial 8 85 Saving an Image 85 Recalling an Image 86 Printing an Image 87 Full Screen Presentation 87 Photographing an Image 88 Video Recording an Image 88	
2.9	Tutorial 9 89 Introduction to Precision Drafting 89 Lock Functions 89 Escaping from a Lock 90 Wipe in the Lock Condition 90 Cancelling a Lock Condition 90 Freehand Drawing with Lock Engaged 91	
2.10	Tutorial 10 92 Vernier Angle Lock 92 Coarse Angle Lock 94 Four Axis Lock 95 Orthogonal Lock 95 Normal Tangent Lock 95	

C O N T E N T S

2.11	Tutorial 11	97
	Locked Grids	97
	Grid Display	97
	Grid Size	98
	Using the Grid	99
	Changing the Grid Spacing	100
	Changing the Grid Position	102
	Rotating the Grid using N-TAN	104
	Rotating the Grid to an Unknown Angle	106
	Setting a Skewed Grid with X and Y	107
2.12	Tutorial 12	109
	Isometric Grids	109
	Preset Grids	111
	Registration marks using Preset Grid	112
	Drawing Schematics using Preset Grid	113
	Copying on to a Preset Grid	114
	Zooming with a Preset Grid	115
	Tangent Arcs with a Locked Grid	117
	Compass Arcs with a Locked Grid	118
2.13	Tutorial 13	120
	How screen images relate to physical drawings	120
	The Library Disk System	121
	Archive Disks	124
	Buffer Disks	125
	Drawing to points defined by intersections	125
	Drawing radial lines	127
	Symmetry in drawing	129

SECTION THREE - REFERENCE

Section		Page
3.0	Introduction	131
3.1	System Menu Functions	132
3.2	Preparing and Formatting Data Disks	133
	Library Disks	133
	Archive Disks	134
	Buffer Disks	134
3.3	Changing and Restoring the Colour Palette ..	135
3.4	Compact Library Disk	136
3.5	Restore Library Disk	136
3.10	Main Functions (Menu 1)	137
3.11	Draw	137
	Lines and Points	137
	Tangent Arcs	138
	Compass Arcs	138
	Circles	139
	Nibs	140
3.12	Paint	140
3.13	Trace	141

C O N T E N T S

3.14	Text	142
3.15	File	143
3.16	Copy	143
	Scale, Rotate and Stretch	144
	X Flip and Y Flip	145
	Colour and Line Type	145
3.17	Erase	146
3.18	Find	147
3.19	Move	148
3.20	Duplicate	149
3.21	Exchange	149
3.22	Zoom	150
3.23	Pan	150
3.24	Page	151
3.25	Utils	151
	Load	152
	Zoom Stores	153
	Screen Images	153
	Select Library Drive	155
	Exit	155
3.26	Wipe	155
3.30	Precision Controls (Menu 2)	156
3.31	Angle Locks	156
	Assignable Angle Locks	156
	Second Angle Locks	157
	Default Angle Locks	157
	Copy with Angle Locks	158
3.32	Grid Locks	158
	Assignable Grid Locks	158
	Non Orthogonal Grids	159
	Default Grid Locks	159
3.33	Copy and Zoom with Locks	159
	Orthogonal Grids	160
	Non Orthogonal Grids	160
3.40	System Information	161
3.41	Data Clipping	161
3.42	File Structure	162
3.43	Editing	163
3.44	Record Lengths	165
3.50	Error Messages	166
	Illegal File	166
	Serious System Error	166
	Library Disk Full	166
	Not Library Disk	166
	Picture Too Complex	167
	Directory Write Error	167
	No Room on Disk	167
Index	168

SECTION ONE

1.0 INTRODUCTION

This section provides details of the computer hardware components needed and installation of the Acorn Bitstik System.

The information contained within this section should be read in full BEFORE trying to use the Bitstik System.

Installing the Acorn Bitstik System involves insertion of ROM components. Whilst installation instructions are given in this section, it is recommended that installation is carried out by an authorised Acorn Computer dealer.

1.1 SYSTEM COMPONENTS

1.1.1 MINIMUM EQUIPMENT NEEDED

To convert a BBC Microcomputer into a powerful graphics system only a single, combined hardware and software package is required.

This is what is needed -

1 A BBC Microcomputer, Model B, fitted with :-

Series 1 Operating System
Disk/Network/Tube Interface
Basic

plus additional peripherals :-

6502 Second Processor
Twin Disk Drives (80 track)
Colour Monitor or TV

2 The Acorn Bitstik Graphics System comprising :-

Controller Unit
Bitstik Graphics ROM
3 Disks
Manual

You may check the current installation by using '*H.' (*HELP) when a '>' prompt is shown. This will result in a display of the current installed components, including version numbers. Consult your dealer if your system needs upgrading.

SECTION ONE

1.1.2 ADDITIONAL EQUIPMENT

The Acorn Bitstik System also supports the use of a BBC Microcomputer JP101 Printer, which can be used to generate a hard copy of any drawing created.

For higher quality output, a fully compatible drafting plotter sub-system is also available. Please consult your dealer for details of this option.

1.2 GETTING STARTED

To install the system yourself you will require:

- A Philips screwdriver
- A small adjustable spanner
- A ROM chip puller (if ROM positions need to be changed)

1.2.1 INSTALLING THE CONTROLLER

Connect the plug on the Controller lead to the ANALOGUE input socket at the rear of the BBC Microcomputer.

1.2.2 INSTALLING THE GRAPHICS ROM

First, disconnect the computer from the mains electricity supply!

Remove the top cover of the BBC Microcomputer by removing the four Philips screws, two on the back panel and two on the bottom near the front edge of the console.

Then release the keyboard by undoing the two bolts, one at either side of the keyboard board. Move the keyboard aside to reveal the ROM sockets (temporarily disconnect the keyboard multipin plug if necessary).

At the FRONT RIGHT HAND SIDE of the Circuit Board are 5 ROM sockets. To enable the Bitstik system to operate, the ROMs listed below must be installed in the computer (for further information refer to the appropriate User Guide).

OS
DNFS
BITSTIK
BASIC

Insert the Bitstik Graphics ROM in a socket, ensuring that the ROM is arranged with the indented edge pointing towards the REAR of the Circuit Board. If necessary, insert the other ROM components in the correct position.

Reaffix the keyboard and top cover in the proper manner.

SECTION ONE

1.2.3 CHECKING THE INSTALLATION

After installing the ROM components required for the Bitstik System, the additional peripherals in the manner described in the appropriate manuals for each peripheral, i.e. the Disk System and 6502 Processor User Guides.

- 1 Switch on the equipment, starting with the second processor.
- 2 Use '*H.' at the '>' prompt to obtain a display of the configuration, and see if all the ROM components are recognised by the system.
- 3 Use the Disk System Utilities disk to check for correct disk drive operation, by running some of the demonstration programs, if necessary.

If the computer does not appear to be functioning correctly, or the correct configuration is not displayed, check the ROM installation and peripheral connections, and retry. Consult your dealer if the problems persist.

1.2.4 SOFTWARE AND DISK VOLUMES

The Bitstik package includes three disks.

One copy of the graphic system software, labelled **SYSTEM MASTER**, containing the Acorn Bitstik System software.

One copy of the **INTRODUCTORY LIBRARY** disk (double-sided with a volume on each side).

One **BUFFER** disk, which is used as a work disk during the drawing process, and must be available in Disk Drive 1.

ENSURE BACK UP COPIES OF THE SYSTEM MASTER DISK ARE MADE, USING THE DISK SYSTEM BACKUP COMMAND, BEFORE USING THE BITSTIK SYSTEM.

To use the system other kinds of disk volumes are also required, which must be created by the user of the system.

A number of your own **Library Disks**, similar to the **Introductory Libraries** but on separate disks, will also be required as you generate drawings.

ARCHIVE disks, a special type of **Library** disk, used to 'file' completed work which is no longer required in an 'on-line' **Library**.

Creating these disks is described in detail in Section 3.

SECTION ONE

For Library and Archive disks, the system uses standard 5 1/4 inch double-sided, double-density floppy disks. Although any compatible disk may be used, the better quality disk is a good investment in the long run.

Caution: DISK HANDLING Floppy disks can easily be damaged by improper handling. NEVER remove a disk from a drive which is still running (RED light ON).

1.2.5 STARTING THE SYSTEM

To start the system follow the steps described below.

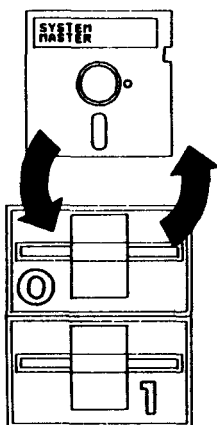

Fig 1

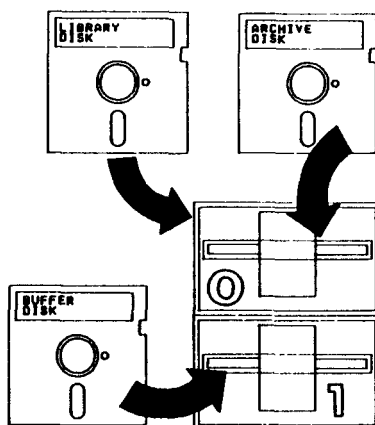

Fig 2

- 1 Before starting, confirm the computer is correctly set up for the Bitatik System and that all the peripheral equipment is connected correctly.
- 2 Starting with the second processor, switch on all the equipment, insert the System Master disk in Drive 0 (see Fig 1), leaving the drive flap open.
- 3 Hold down the SHIFT key, press the BREAK key, then release the BREAK key, and the disk drive light will come on.
- 4 Close the disk drive flap.

S E C T I O N O N E

5 On the screen you will see a title page followed by a list of options, called the 'System Menu'.

- 1 RUN GRAPHICS PROGRAM
- 2 FORMAT LIBRARY DISK
- 3 FORMAT ARCHIVE DISK
- 4 FORMAT BUFFER DISK

- 5 CHANGE PALETTE
- 6 RESTORE PALETTE
- 7 COMPACT LIBRARY DISK
- 8 RECOVER LIBRARY DISK

- 9 EXIT TO BASIC

LOADING THE GRAPHICS PROGRAM

To go direct to the graphics program:

- 1 Press '1' on the keyboard, to select RUN GRAPHICS PROGRAM.
- 2 Wait while the software loads (disk drive whirrs, with the red light on).
- 3 When software loading is complete, (the drive stops, and light goes out) you will be prompted to load a Library disk in drive 0 and Buffer disk in drive 1.
- 4 At this point, insert the Introductory Library disk into Drive 0 and insert the Buffer disk into Drive 1 (Fig 2).
- 5 Close both drive flaps.
- 6 Press RETURN key on the computer keyboard, the disks are validated by the system and Work Page screen appears. If the system 'beeps', check that the correct disks have been inserted and press RETURN again.

The Acorn Bitstik Graphics System is now ready for use!

S E C T I O N T W O

2.0 INTRODUCTION

This section of the manual is a series of hands-on tutorials on the System.

It is assumed here that the hardware components are connected and functioning properly (refer to Section 1).

The System is powerful and comprehensive, with capabilities usually found only in dedicated CAD systems. However, there's one key difference, the system is easy to use!

A few hours of practice with the tutorials will teach you the system's basic functions, showing you just how easy it can be to produce useful, impressive graphics. Although we call these functions 'basic', we think you'll be surprised by their potential.

The system's more advanced functions, especially those relating to precision drafting, are covered in the Precision Drawing Tutorials.

Don't be afraid to experiment with the system, it costs very little to erase mistakes! Your artwork is created - and modified - electronically, and nothing is committed to paper until you are absolutely satisfied.

There are eight tutorials concerned with basic functions and four deal with advanced features needed for precision drawing. The last tutorial covers various 'ad hoc' topics and techniques.

Each tutorial is self contained and learning sessions can be broken between tutorials. However, exercises within tutorials, showing different features, assume that previous material created is still available for further exercises, so organise your learning periods based on complete tutorials.

Each tutorial begins with a brief introduction indicating the functions covered within it.

S E C T I O N T W O

2.1 TUTORIAL 1

Tutorial 1 introduces basic topics, and shows how to begin using the system.

The Controller and how to use it

The Work Page screen display

Making Menu selections

Making Palette selections

Changing Library Drive

2.1 STARTING THE TUTORIALS

If you are starting the tutorial exercises without having previously dealt with the Acorn Bitstik System, or Section 1 of this manual, here a few points to note before you start.

The system software is supplied on a floppy disk labeled 'System Master', which contains the graphics system programs.

Also supplied is an Introductory Library disk, containing material for use with the tutorials.

Ensure you have the formatted Buffer disk, which is supplied with the system.

Now follow the instructions in Section 1 on starting the system. Continue with this tutorial once the system is ready.

2.1.2 THE CONTROLLER

The Controller is designed to be used as an extension from the computer console, so you can make yourself comfortable and concentrate on the screen.

Try to operate the controls by touch, keeping your eyes on the screen, and you will soon be using the Controller as proficiently as you would a pencil.

Controller commands are summarized below.

SECTION TWO

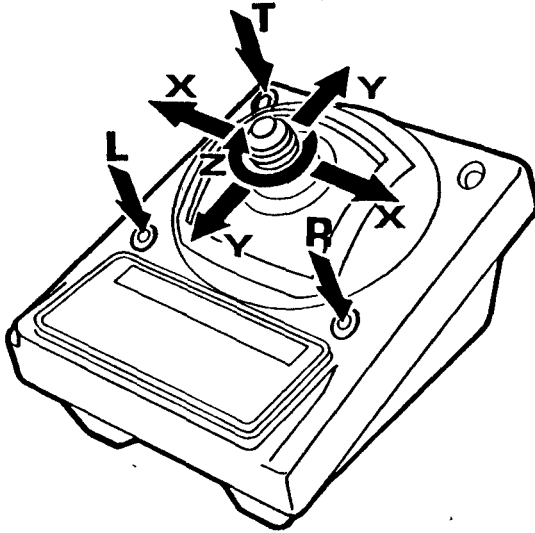

The Controller

CONTROLLER COMMANDS

The Controller is designed to provide a wide range of command inputs with only a small number of controls. In general, the controls function as stated below.

The stick, denoted **XY**, controls position during drawing by up/down, left/right or diagonal movement.

The knob, denoted **Z**, controls scale, rotation and proportion ('stretch') by rotating it.

Left button, denoted, **L** confirms a selection

Right button, denoted **R**, generally provides a 'release' function

Top button, denoted **T**, executes a command

For example - Two frequent actions required

Press **L** and **R** buttons at the same time to escape from the Menu functions.

Clear the screen by selecting **WIPE** on the menu, then pressing **L** and **T** buttons at the same time.

SECTION TWO

CONTROLLER OPERATING TIPS!

Use one hand for 'stick' and control knob movements, and the other for all button presses.

The buttons are usually operated by a **press and release** action, although sometimes you will have to **press and hold** a button.

When a press and release action is used, the system accepts the instruction only when the button is **released**.

The following abbreviations are used throughout the Tutorials concerning the Controller.

Move XY	Move stick as indicted in tutorial text
Rotate Z	Rotate Z Control Knob
L	Left button
R	Right button
T	Top button
L and R	Left and Right buttons at the same time
L and T	Left and Top buttons at the same time
origin cursor	The term 'origin cursor' is used to denote the 'x' shaped cursor which defines start point when drawing.
dynamic cursor	The term 'dynamic cursor' is used to denote the '+' shaped cursor which defines end point when drawing.

2.1.3 ON THE SCREEN

Once the system software has loaded itself into the computer, you will see a list of items down the right side of the screen, called the Menu, and groups of items in a line along the bottom, called the Draw Palette. See (Fig 1).

The main area of the screen is called the Work Page - this is where you do your drawing. On the Work Page you will see a 'x' and an '+' joined by a line.

These are the Origin and Dynamic Cursors. With the cursors, which you can move around with the Controller, you can create your drawing on the Work Page, and you can make selections from the Menu and Palette.

The line connecting them, which stretches and contracts as the Dynamic Cursor is moved, indicates where the actual line would be drawn and is called the 'rubber band' cursor (for obvious reasons). It is especially helpful when drawing arcs, as you will see. The system provides other palettes and menus, which are described later in the tutorials.

SECTION TWO

MENU 1	MENU 2
MENU	MENU
DRAW PAINT TRACE TEXT	ANGLE -8 8 198 0
FILE COPY	ANGLE -8 198 0
ERASE FIND MOVE DUPL EXCH	ORTH N-TAN
ZOOM PAN PAGE	GRID V32 V32 8XB 8XE
UTILS WIPE	
8888	8888

Fig 1

- 1 Move XY to move the dynamic cursor to MENU (top right corner), and a flashing white box appears around the word MENU. Hold the stick there for now.
- 2 Press and release L to confirm your selection, and another MENU will appear (this is Menu 2, which you will use in Precision Drawing Tutorials).
- 3 Move XY to the left, away from the MENU flag to get the cursor back within the Work Page.
- 4 Move XY to MENU, then confirm by press and release L to return to Menu 1.
- 5 Move XY away from the MENU flag to get the cursor back on the Work Page. Notice that the DRAW function is selected automatically on moving into the Work Page.

For the moment **DO NOT** try making selections from either MENU! Each function is described separately in the following pages.

MEMORY COUNTER

In Fig 1, at the bottom of Menu 1 is a four digit number. This is the MEMORY COUNTER. The count reduces as your drawing develops, indicating the amount of computer memory remaining for your drawing. You'll hear an AUDIBLE BEEP when the memory is nearly full!

SECTION TWO

At that point, when drawing for real, you would FILE your drawing (Sect 2.2.6), clear the screen using WIPE (Sect 2.2.4), which will reset the COUNTER, then COPY your drawing (Sect 2.2.7) and continue.

Filling memory takes a lot of drawing detail and will not happen during these tutorials, so just remember the above procedure and note the effect on the MEMORY COUNTER as you use different drawing functions in the tutorials.

2.1.5 PALETTE

Using the palette at the bottom of the screen is just as simple. As with the Menu, all selections are made with the Controller.



Fig 1

- 1 Move XY to aim the dynamic cursor at any of the colour blocks in the middle of the palette (Fig 1).
- 2 Move XY to move the dynamic cursor vertically down to the bottom of the screen, through the chosen colour. The white triangle will jump to the chosen colour and you will hear a beep.
- 3 Move XY to move the origin cursor straight up (if you nudge the triangle you will make another colour selection). If you do this by accident just repeat the actions to reselect your chosen colour.

Other selections can be made from the palette in a similar way. You don't need to press any buttons to confirm a selection. To escape from a particular palette selection, you simply choose something else from the palette. If you have difficulty escaping, here is a general procedure to follow.

SECTION TWO

ESCAPE FROM PALETTE SELECTION

- 1 Press and hold R to regain normal dynamic cursor action.
- 2 Move XY into the bottom left corner of the screen, then release R, and normal line drawing will be selected.

Try selecting various different items from the palette to see what happens, and then return the screen to its original state before you continue by following the instructions below.



Fig 2

- 1 Select the symbol marked 1 in Fig 2, from the bottom left corner of the palette. This selects the straight line mode.
- 2 Select the symbol marked 2 in Fig 2, from the middle of the palette. This selects the white line drafting mode.
- 3 Select the symbol marked 3 in Fig 2, from the right of the palette. This selects the continuous line mode.

Often in these tutorials you will be asked to draw in 'continuous white line', this means that both (2) and (3) must be selected, together with whatever line shape (straight, curve, circle, etc) you need.

Fig 2 shows the palette selections grouped under the four different categories, Line Shape, Nib, Line Colour, and Line Type that you will deal with in more depth in later tutorials. Just note the names and grouping for now.

Caution! Keep an eye on the palette (and an ear open) while you are drawing, otherwise you might accidentally change your palette selection.

SECTION TWO

2.1.6 CHANGING THE LIBRARY DRIVE

As mentioned earlier in the tutorial, the Introductory Library disk contains two volumes, one on each of the surfaces of the disk. These Libraries are used to store drawings and you will learn more about them in the next tutorial.

There are four drives available in the system, numbered 0-3, and a maximum of two different libraries can be loaded at one time, using Drives 0 and 2. Drive 1 (and 3) are reserved for the Buffer Disk.

However, only ONE Library at a time can be 'attached' to the system. If you wish to change from one Library to another during a drawing session or tutorial the procedure to follow is shown below.

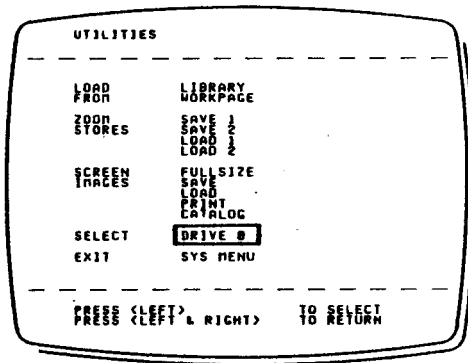

Fig 1

- 1 Move XY to move the dynamic cursor to the UTILS flag on the Menu. When it is flashing, press and release L to confirm the selection.
- 2 The display changes to a different menu, the Utilities Menu, which you will use fully in later tutorials, so ignore everything shown except 'SELECT DRIVE'.
- 3 Move XY to place the white bar over 'SELECT DRIVE' so that it is illuminated. Hold it there and then press and release L.
- 4 The display changes to show the new Library drive attached to the system.
- 5 Press L and R together to return to the Work Page.

Use this procedure to change the current library drive whenever necessary.

S E C T I O N T W O

2.2 TUTORIAL 2

Tutorial 2 introduces the basic functions necessary to carry out any drawing task and you will actually begin to draw with the system. Functions covered are summarised below.

Drawing with lines

Erasing incorrect lines

Filing a drawing onto a disk

Redisplaying a drawing after making alterations or erasures

Resetting the system by wiping out the drawing

Storing and retrieving pre drawn units from a Library Disk

Erasing incorrect Library Units copied into a drawing

2.2.1 DRAW

Ensure the screen is in its original state ... DRAW on the main menu, and straight, white continuous lines on the palette. (This is also the start condition you have when the Menu is first loaded). You can change these selections anytime, but leave them as they are for now and try this quick exercise.

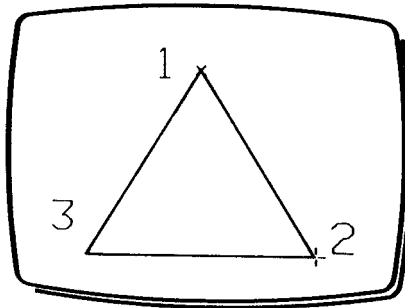

Fig 1

To Draw a triangle!

- 1 Move XY to move the dynamic cursor to (1) in Fig 1.**
- 2 Press and release L to position the origin cursor.**

S E C T I O N T W O

- 3 Move XY to move the dynamic cursor to (2) in Fig 1.
- 4 Press and release T to draw the line.
- 5 Move XY to move the dynamic cursor to (3) in Fig 1.
- 6 Press and release T to draw the line.
- 7 Return the dynamic cursor to (1) in Fig 1.
- 8 Press and release T to draw the line.

2.2.2 ERASE

If you make a mistake at any point, you can use ERASE to remove the incorrect line. Using L or R lets you go through each entry drawn, in sequence, to select the one to erase. Lets use the triangle just drawn to show this.

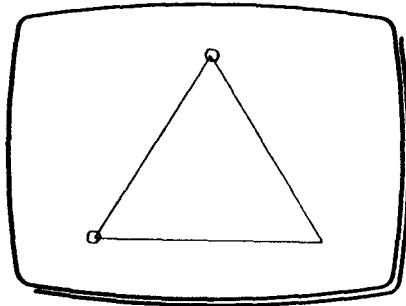

Fig 1

- 1 Select ERASE from Menu, then press and release L, and two small diamond shaped cursors mark the ends of the last line entered.
- 2 Press and release L several times to step BACK through your drawing sequence.
- 3 Then press and release R several times to step FORWARD through the sequence.
- 4 Press and release T to erase the line marked with the cursors, and the selected line is removed from the display.
- 5 Press and release L and R together, then move XY back into the Work Page to exit ERASE and return to DRAW (this happens automatically if you remove all of your drawing).

2.2.3 PAGE

How to clean up your drawing!

After using ERASE on complex drawings, you may see pieces missing from your drawing on the screen. This is because lines are erased by overdrawing in black. To show this, draw several HORIZONTAL and VERTICAL criss-crossing lines, using what you have just learnt, then ERASE some of them.

TRY THIS ON YOUR OWN NOW!

Gaps will appear, but this is a display effect only, which you can eliminate simply by selecting, PAGE from the Menu then press and release L. Your drawing will replay on the screen without gaps.

TRY SELECTING PAGE NOW AND WATCH YOUR DRAWING REDRAWN ON THE SCREEN

PAGE can be used anytime to replay the contents of the screen memory.

2.2.4 WIPE

If you wanted to remove all the drawing in memory in one go ERASE is not very useful, as it only does one entry at a time. To remove all entries made currently in the memory you must use WIPE. This resets the system and forgets all the previous entries.

Caution! WIPE is an instant eraser - it takes out everything on the screen at once, so use it with care.

Lets try removing all the entries we have made so far.

- 1 **Select WIPE from the Menu.**
- 2 **Press and release L and T together to confirm, and the screen display and counter clears.**
- 3 **Move XY away from WIPE to return to the DRAW function.**

SECTION TWO

2.2.5 LIBRARY DISKS AND LIBRARY INDEX

The Library Disk, with its Library index of miniature drawings, is one of the most powerful features of the system.

Drawings can be transferred to and from the Work Page at will, using the FILE and COPY functions. They can be endlessly modified, manipulated and re-used time and again - singly or in any combination,

On the Library Disk are three index pages, A, B and C, each with a number of boxes for miniatures of the drawings stored on the disk. Each index has a different number of boxes so that a drawing can be stored according to the complexity of index display detail you require.

The following information and exercises show how the Library feature works, and how it is used.

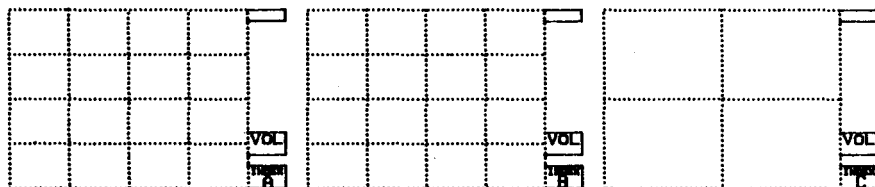

Fig 1 - The three index pages of the Introductory Library

Use the Copy function to view the contents of the Library Disk Indexes

- 1 Clear the screen using WIPE.
- 2 Select COPY from the Menu, then press and release L to confirm, and the Work Page will be replaced by Library Index A, which looks like a mosaic of miniature pictures. The pictures are pre-drawn material provided as part of the Introductory Library.
- 3 Press and hold R until disk drive whirrs, then release R. Index A is replaced by Index B.

S E C T I O N T W O

- 4 Repeat to view Index C.
- 5 Press and hold L to step back to Index A.
- 6 Press and release L and R together to exit from COPY.

Note: Selecting indexes can be done with either L or R depending on the direction required, but the buttons must be held down until the direction is sensed by the system.

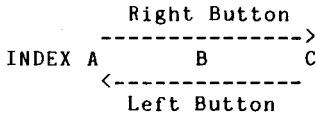

FILING DRAWINGS IN THE LIBRARY AND RETRIEVING THEM

You can file the Work Page drawing on the screen to an empty box on a Library disk at any time. A drawing filed in this way is known as a 'Library Unit'.

The Work Page can be filed at any stage of completion, and it can be any kind of drawing; original material just drawn by you, or a composite drawing assembled from original material plus other library units.

A drawing stored as a Library Unit and subsequently copied into other drawings, is treated by the system as a single entity, irrespective of the number of original entries made to create it. For example, a unit can only be erased completely, not partially.

For normal use of library units during drawing, the functions FILE, COPY, EXCH, and DUPL are used. However, where a Library unit has to be retrieved in its original form, for example to modify it; special utility functions, LOAD FROM LIBRARY and LOAD FROM WORK PAGE, are provided. All these functions, and how to use them, are covered in this, or subsequent tutorials.

As well as being used in the drawing process, the Library function is also used as the normal means of storing your own completed drawings, either on normal Library disks or on Archive disks. When you are creating a drawing remember to reserve space to file your completed drawing and use it to retain interim versions while drawing.

Filing, or 'backing up', is something you should do routinely every half hour or so. A power failure, a power glitch or accidental interference by someone else can destroy hours of original work.

BACK-UP YOUR DRAWINGS TO THE LIBRARY EVERY 30 MINUTES OR LESS!

SECTION TWO

2.2.6 FILE

Once you have completed a drawing, you can place a version of it on to the Library Disk, thus creating a library unit. This function is called FILE on the Menu, and is not the same as the COPY function; which is used to retrieve a library unit.

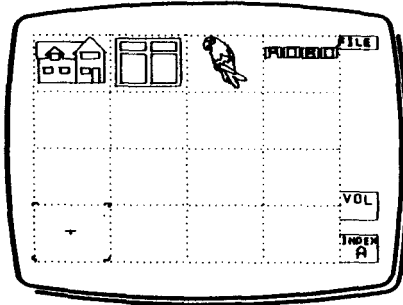

Fig 1

- 1 Draw a triangle as before, as you did in the previous exercise.
- 2 Move XY to select FILE from the Menu, then press and release L to confirm. The Work Page will be replaced by the LIBRARY INDEX, which looks like a mosaic of miniature pictures in boxes (see Fig 1). The cursor changes to to an outline framing a box. Notice that the volume number and index page letter are shown for identification.
- 3 Move XY to move the cursor frame to an empty box.
- 4 Press and release T to file the drawing in the box. A miniature of your drawing will appear in the box, and you will be asked to give it a name.
- 5 Ignore the 'ENTER LABEL' prompt for the moment.
- 6 Press and release L and R together to return from the library index, and your original Work Page will reappear.

You can now continue drawing on the page, or you can WIPE the screen to be ready for the next job. Now that you have filed the drawing, WIPE is not catastrophic! The drawing disappears from the screen, but isn't lost forever, you can recover it in two ways, both shown in later tutorials, (COPY 2.2.7 and Editing 2.7)

S E C T I O N T W O

Caution! When using FILE, make sure the cursor frame is on an empty box before confirming with T. This is because FILE will overwrite other material already in the Library, just like a tape recorder, if you choose to do it by using a box already occupied.

2.2.7 COPY

You can copy drawings from the Library Index on to the Work Page anytime using COPY. The drawings are handled as complete library units. You can also adjust the size and orientation of a library unit to suit the particular drawing you are doing by using the Copy Palette.

- 1 Clear the screen (select WIPE from the Menu, then press and release L and T together).
- 2 Select COPY from the Menu, then press and release L, the Work Page will be replaced by the Library Index.
- 3 Move XY to move the cursor frame to your selected unit (use your triangle).
- 4 Press and release T to select the drawing. The Work Page will reappear blank, but with the cursor changed to a frame set to Work Page size. Press and release T and the chosen unit (your triangle) is drawn on the Work Page. (You may have to rotate X to see the corners of the frame).
- 5 Note the new palette at the bottom of the Work Page (See Fig 1).

SCL 100.0 ROT 0 STR 50.0 X FLIP Y ■ |—|

Fig 1

You will have noticed that COPY calls up a different palette at the bottom of the screen (see Fig 1).

The labels SCL, ROT and STR are shown on the Palette. The numbers next to the palette labels will change as you alter the size, rotation, or stretch of the cursor frame. Read the information below to see what each one means.

S E C T I O N T W O

SCL Indicates the scale of the copied library unit as a percentage (100 = full size).

ROT Displays the rotation of the copied library unit in the range 0 to 360 degrees, in 5 degree steps.

STR Displays the proportion (i.e. stretch or squeeze) of the copied library unit, on an scale from 0 to 100, the unmodified state is 50.

You can lock any of the above numbers at a chosen setting simply by touching the required label with the centre of the cursor frame - one touch to lock, and again to unlock. The locked state is shown by a white triangle over the label.

In a similar way you can switch on and off other COPY functions which affect the copied library unit when you plant it. These functions are FLIP, Line Colour change, and Line Type change which are covered in later tutorials.

COPY (continued)

As has just been described, you can copy drawings from the Library Index onto the Work Page anytime using SCL, ROT and STR. The following exercises show you how to do this in a complete sequence.

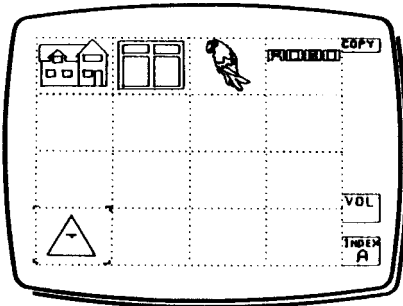

Fig 1

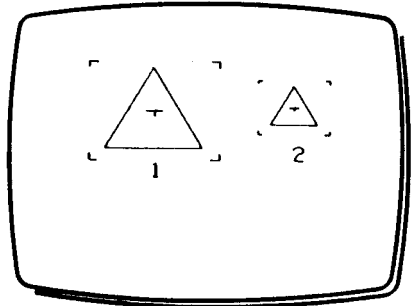

Fig 2

COPY

- 1 First clear the screen (select WIPE from the Menu, then press and release L and T).
- 2 Select COPY from the Menu, then press and release L. The Work Page will be replaced by the Library Index (Fig 1).

SECTION TWO

- 3 Move XY to move the cursor frame to your selected drawing (use your triangle again).
- 4 Press and release T to select the drawing, and the Work Page will reappear blank, but with the cursor frame at page size.

SCALE

- 1 Rotate Z to alter the cursor frame size. Rotate it fully in each direction the obtain the full scale range, (notice the changing value of SCL).
- 2 Move XY to position the cursor frame at (1) in Fig 2.
- 3 Press and release T to draw the library unit.
- 4 Rotate Z to alter the size again.
- 5 Move XY to position the cursor frame at (2) in Fig 2.
- 6 Press and release T to draw the library unit at the new size.

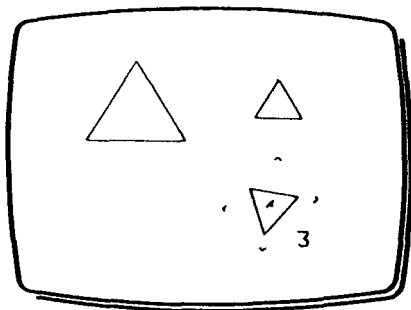

Fig 3

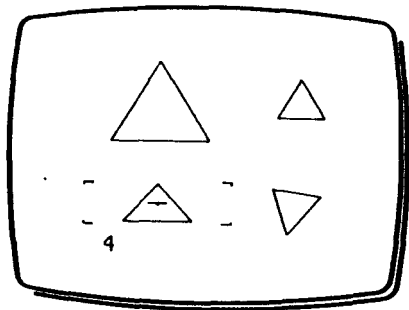

Fig 4

ROTATE

- 1 Press and hold L, and rotate Z to rotate the cursor frame (notice the changing value of ROT).
- 2 Release L when you have the required rotation.
- 3 Rotate Z to alter the size, and move XY to position the cursor frame at (3) in Fig 3.
- 4 Press and release T to draw the library unit.

S E C T I O N T W O

- 5 **Press and hold L and rotate Z to return the cursor frame to its original orientation, (ROT 0).**

STRETCH (proportion)

- 1 **Press and hold R then rotate Z to stretch or squeeze the cursor frame (notice the changing value of STR).**
- 2 **Release R when the cursor frame is proportioned as (4) in Fig 4, then rotate Z to alter the size, and move XY to position the cursor frame at (4).**
- 3 **Press and release T to draw the library unit.**
- 4 **Press and hold R and rotate Z to return the cursor frame to its original proportion (STR 50).**

Note: If you wished to remove a copied unit you would use ERASE, which is covered in the next tutorial.

MULTIPLE DRAWING OF THE SAME LIBRARY UNIT

With the COPY function and repeated operations of the T button, you can plant as many copies of the library unit as you like using scale, rotation and proportion in any combination.

TRY PLANTING MORE UNITS, FROM WHAT YOU HAVE LEARNT ABOUT COPY!

2.2.8 ERASING COPIED LIBRARY UNITS

If you wish to remove a library unit which you transferred to the Work Page from the Library, you use the ERASE function in a new way.

- 1 **Make sure you are still in COPY.**
- 2 **Select ERASE from the Menu using centre of the cursor frame to make the selection.**
- 3 **A flashing frame marks the last library unit planted on the screen.**
- 4 **Press and release L to step BACK through the planting sequence.**
- 5 **Press and release R to step FORWARD through the planting sequence.**

S E C T I O N T W O

- 6 When you arrive at a library unit you wish to remove, press and release **T** to erase it, as in Fig 1.
- 7 Press and release **L** and **R** to return to **COPY**.

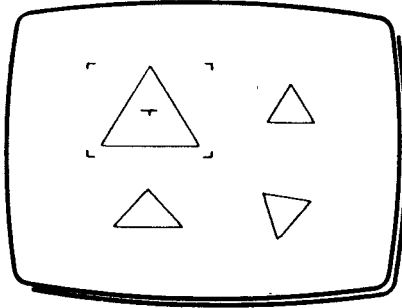

Fig 1

EXIT FROM COPY

To exit from **COPY**, since you have completed the tutorial, press and release **L** and **R** together.

SECTION TWO

2.3 TUTORIAL 3

This Tutorial introduces some additional functions shown on the Draw Palette.

Drawing Circles

Drawing Ellipses using library units

Changing Line Colour

Changing Line Type

Filling in areas of drawings with 'Paint'

How to do simple animated drawings

Locating a Point

2.3.1 CIRCLES

Circles can be drawn in a single step by selecting the circle drawing cursor from the Draw Palette.

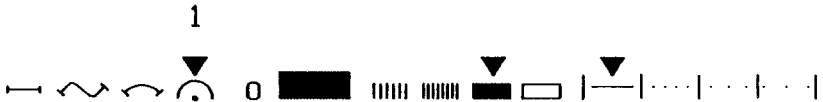

Fig 1

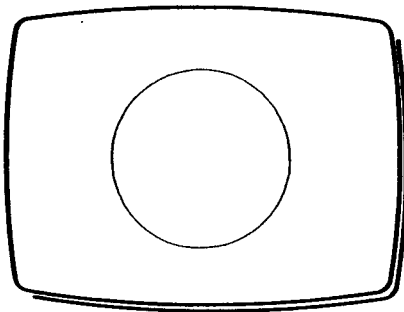

Fig 2

S E C T I O N T W O

- 1 **F**irst, clear the screen using **W**IPE.
- 2 **M**ove **X****Y** away from the **W**IPE label to return to the **D**RAW function.
- 3 **S**elect the symbol marked (1) in Fig 1, from the palette.
- 4 **M**ove **X****Y** to move the cursor vertically back up into the Work Page. The cursor itself is now a circle under **X****Y** control.
- 5 **R**otate **Z** to alter the size of the circle.
- 6 **P**ress and release **T** to draw the circle (Fig 2).
- 7 **M**ove **X****Y** to make the circle visible.

If you wish to remove a circle, you use the **E**RASE function.

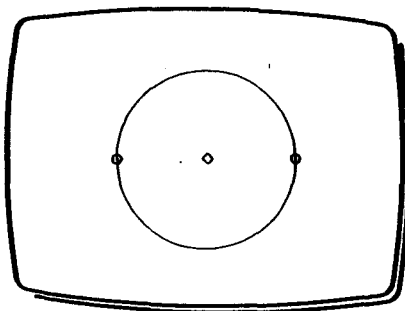

Fig 3

- 1 **S**elect **E**RASE from the Menu using the centre of the circle to make the selection.
- 2 **P**ress and release **L** to confirm.
- 3 **T**wo small cursors will mark the circumference of the circle and a small diamond will mark the centre of the circle (Fig 3).
- 4 **P**ress and release **T** to remove the circle.
- 5 **E**xit **E**RASE by press and release **L** and **R** together.

Note: If you have more than one circle on the screen, you can press and release **L** or **R** go to each one to select the circle to be erased.

SECTION TWO

2.3.2 ELLIPSES

You can generate perfect ellipses, with Copy Palette functions, by squeezing circles copied from the Library.

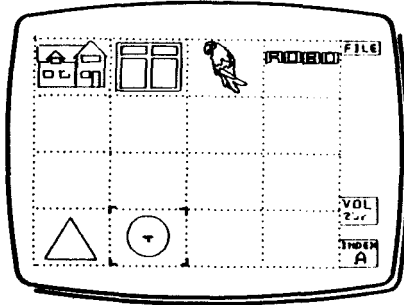

Fig 1

- 1 Clear the screen using **WIPE** and draw another circle.
- 2 Select **FILE** from the Menu using the dot in the centre of the circle cursor to make the selection, and press and release **L** to confirm.
- 3 Press and release **T** to file your circle in an empty library box (Fig 1).
- 4 Press and release **L** and **R** together to skip the request for labelling.

You can now use this stored circle to generate an ellipse.

- 1 Clear the screen using **WIPE**.
- 2 Select **COPY** from the Menu.
- 3 Move **XY** to position the cursor frame over the box containing your circle.
- 4 Press and release **T** to select it, and the Work Page will re-appear.

SECTION TWO

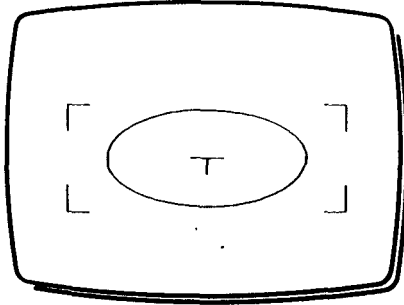

Fig 2

- 5 Move XY to position the cursor frame and rotate Z to size it.
- 6 Press and hold R and rotate Z to squeeze the cursor frame.
- 7 Release R when the frame is proportioned as in Fig 2.
- 8 Press and release T to draw the 'squeezed circle', as a perfect ellipse.
- 9 Press L and R to exit COPY.

Using just the one stored circle in different proportions, sizes and rotations, you can produce any ellipse you like. Try some for practice!

Note: If you wish to remove any of the ellipses from the screen, use ERASE as described for copied library units, (Sect 2.2.8).

2.3.3 LINE COLOUR

You can draw in any of four colours on the Draw Palette.



Fig 1

S E C T I O N T W O

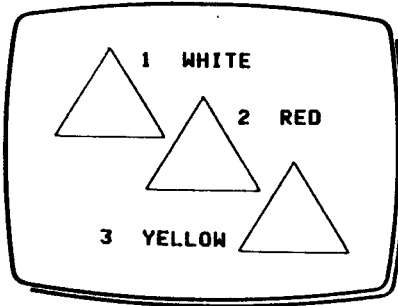

Fig 2

- 1 **Clear the screen using WIPE.**
- 2 **Draw a triangle with WHITE lines, (1) in Fig 2.**
- 3 **With the dynamic cursor select RED from the palette, you will hear a beep to confirm.**
- 4 **Draw a second triangle, (2) in Fig 2.**
- 5 **Return to the palette and with the dynamic cursor select YELLOW.**
- 6 **Draw a third triangle, (3) in Fig 2 and then reselect WHITE.**

You will see that the 'rubber band' between cursors is always white, but the confirmed line takes the colour of the palette selection.

Note: You can change the selection of colours available on the Draw Palette with the Change Palette option, on the System Menu.

Caution! Colour 4 is BLACK, and is invisible when used to draw with on a normal screen. It is useful for drawing on coloured backgrounds, (see PAINT). Drawing a black line over the top of an existing line can be used for screen effects, but is NOT the same as ERASE.

SECTION TWO

2.3.4 LINE TYPE

In addition to colour selections, there is also a choice of four line types on the palette.



Fig 1

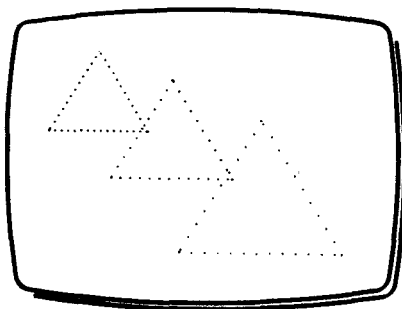

Fig 2

- 1 Clear the screen using **WIPE**.
- 2 Select any of the three types of broken line from the right of the palette see Fig 1. A beep will confirm your selection.
- 3 Draw triangles, rectangles and circles to see the effect (see Fig 2).
- 4 Select continuous line again, to continue normal drawing.

You can select a different line type any time in the drawing process.

SECTION TWO

2.3.5 PAINT

You also have a rapid paint facility you can use to fill any enclosed area on the screen with colour. Before you use PAINT, you will need to draw some shapes on the screen.



Fig 1

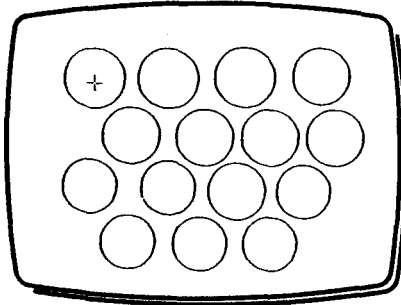

Fig 2

- 1 Clear the screen using WIPE and select circle cursor from the palette.
- 2 Draw a number of circles, keeping them separate, as shown in Fig 2.
- 3 Select PAINT from Menu, using the centre of the circle cursor to make the selection. The palette will change to give you the choice of 16 colours, and the cursor to a dynamic cursor, see Fig 1.
- 4 Select a colour from the palette (any except BLACK on the far right).
- 5 Move XY to position the dynamic cursor inside one of the circles.
- 6 Press and release T to paint the circle with colour.
- 7 Select another colour.

- 8 Paint a second circle.
- 9 Repeat until all the circles are painted, but don't clear the screen! It is used in the next exercise (ANIMATION 2.3.6)

Try experimenting with PAINT outside these tutorials to discover all its possibilities. Be creative! You can always ERASE or WIPE if the screen gets into a mess.

THINGS TO WATCH FOR WHEN PAINTING

- * If there is gap in the boundary of a shape, the colour will leak out and fill the screen.
- * You can remove a colour entry with ERASE, but the colour will remain on the screen until you clean up the drawing with PAGE.
- * Once an area is filled with one colour, you cannot overpaint it with another until you erase the first. The exception to the above is black. Black overpainting causes colour in the selected area, and anything touching it, to disappear. However, you can remove black with ERASE; followed by PAGE to restore the original colour.
- * Painted areas will be reproduced when your drawing is printed using a dot matrix type printer, and coloured areas will appear as patterns or tones if the printer is monochrome only.

2.3.6 ANIMATION

In Sect 2.3.5 we tried PAINT. Now you can try overpainting the drawings left from that exercise with black, to achieve a most unusual effect.

- 1 Select BLACK from the far right of the palette.
- 2 Move XY to position the dynamic cursor within one of the painted circles.
- 3 Press and release T to paint the circle black.
- 4 Repeat until all the circles have disappeared.

You now have a blank screen, but ... your entire drawing since the last WIPE is still in the screen memory, even though you can't see it! This is because you have black circles on a black background.

SECTION TWO

Now store this apparently blank page, this time you'll need to label the index box so you can distinguish it from all the other empty boxes!

- 1 Select **FILE** from the Menu.
- 2 Move **XY** to position the cursor frame over the chosen empty index box.
- 3 Press and release **T** to file the drawing in the box (more correctly, this is a drawing sequence rather than a drawing).
- 4 Using the computer keyboard, type in the label 'MOVIE' then press **RETURN** key.
- 5 When the Work Page re-appears, select **PAGE** and watch the results.
- 6 Clear the memory using **WIPE**.

Amazing! The entire drawing, including the black overpaint, has been re-played in the original sequence. This gives you some idea of the system's potential for instant animation.

2.3.7 FIND - Locating a point

One of the most difficult jobs to do well in drawing, even with pencil on paper, is ensuring that lines which are supposed to meet at a point, actually do so. With this system this isn't a problem, there is an automatic **FIND** function you can use to locate the start of new lines on any previously drawn point.

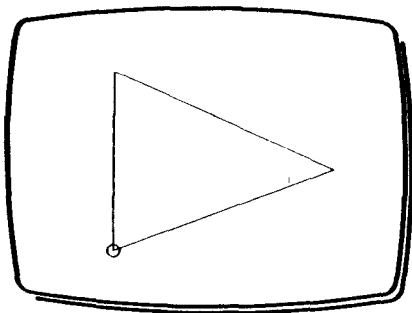

Fig 1

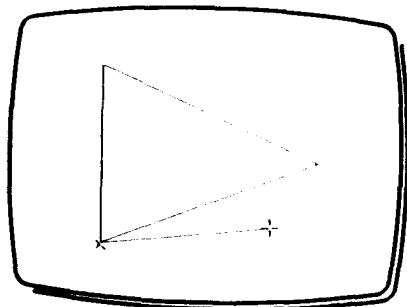

Fig 2

- 1 Clear the screen using **WIPE**.

S E C T I O N T W O

- 2 Draw a triangle on the screen.
- 3 Select **FIND** from the Menu. A small diamond then marks the end of the line last entered, as in Fig 1.
- 4 Press and release **L** to step back through the drawing sequence. Note, there are two end points at each intersection, so the cursor may not appear to move.
- 5 Press and release **R** to step forward through the drawing sequence.
- 6 Press and release **L** or **R** to select one of the three points of the triangle, then press and release **T** to plant the origin cursor at the marked point.
- 7 Move **XY** back in to the Work Page, and you are now back in **DRAW** with the origin cursor at the new position. You can now continue the drawing precisely from the chosen point, as in Fig 2.

Note: With circles and arcs, the **FIND** function locates centres and end-points in sequence.

Press and release **T** at any time to exit **FIND**.

S E C T I O N T W O

2.4 TUTORIAL 4

Tutorial 4 introduces the following topics.

Tangent Arcs

Tangent Arcs and Lines

Compass Arcs

2.4.1 TANGENT ARCS - AUTOMATIC ARCS (1)

As well as drawing straight lines and circles, there are two other line drawing modes which you can select from the palette at any time. The first of these is called Tangent Arc (TAN ARC). The TAN ARC mode is denoted by the symbol shown at (1) in Fig 1 below. It is used for drawing an arc of a circle given a start direction and an end-point. The start direction is usually defined by the last line drawn on the screen, but you can change this if you wish.



Fig 1

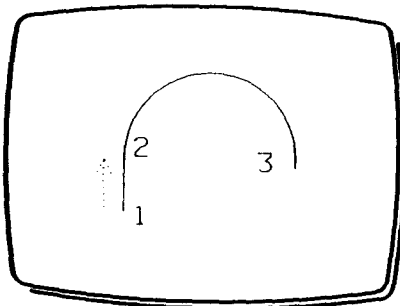

Fig 2

- 1 Clear the screen using WIPE.
- 2 Draw a straight line from (1) to (2) in Fig 2, this defines the arc direction.

S E C T I O N T W O

- 3 **Select the arc symbol (1) in Fig 1.**
- 4 **Move XY to position the dynamic cursor at (3) in Fig 2. This is the arc end-point.**
- 5 **Press and release T to draw the arc.**
- 6 **Select LINE from the palette to exit from TAN ARC.**

Note: Palette selection escape. If you're having difficulty changing a palette selection, move XY to bottom left corner of the Work Page and press and release R.

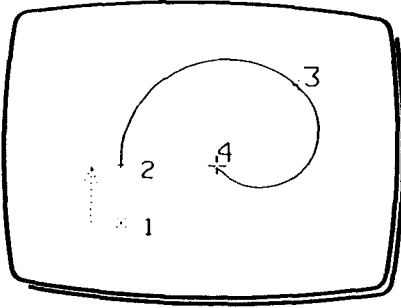

Fig 3

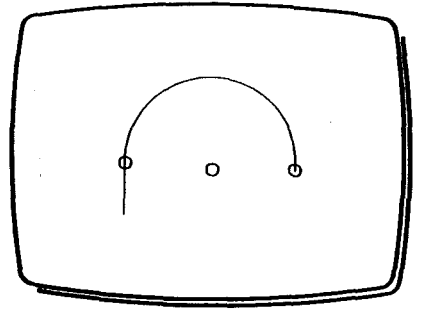

Fig 4

Now try starting an arc in space, without a line reference,

- 1 **Clear the screen using WIPE.**
- 2 **Select the arc symbol from the palette.**
- 3 **Move XY to position the dynamic cursor at (1) in Fig 3.**
- 4 **Press and release L to position the origin cursor at this point.**
- 5 **Move XY to position the dynamic cursor at (2) in Fig 3.**
- 6 **Press and release L to position the origin cursor. You have now defined the arc direction.**
- 7 **Move XY to position the dynamic cursor at (3) in Fig 3. This defines the arc end-point.**
- 8 **Press and release T to draw the arc.**

SECTION TWO

- 9 Move XY to position the dynamic cursor at (4) in Fig 3. Note that the second arc is a smooth continuation of the first.
- 10 Press and release T to complete the second arc.
- 11 Clear the screen using WIPE.

Note: ERASE works with arcs as it does with lines, but in this case three points are marked by the small diamonds to indicate the entry, at the centre and two end points, see Fig 4.

Now try a few variations with TAN ARC. With practice you will soon be drawing any arc you wish by judging the combination of start direction and end points. Try the examples below yourself.

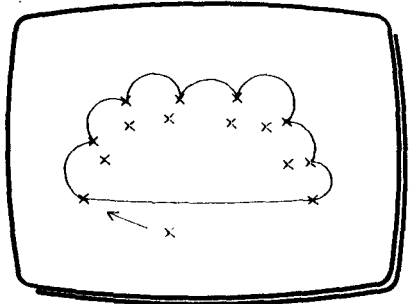
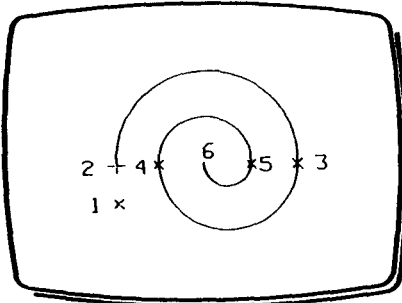
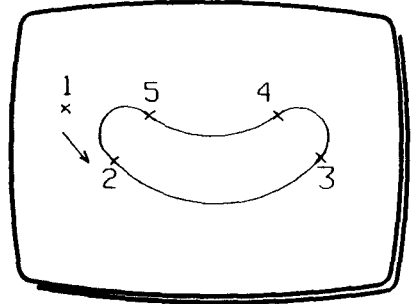
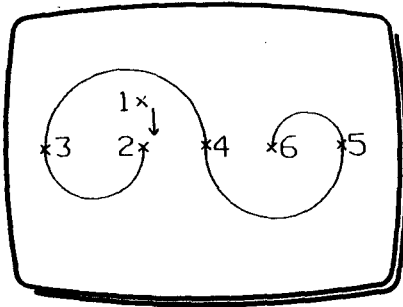

FOR YOUR INFORMATION

The straight arc - a special case

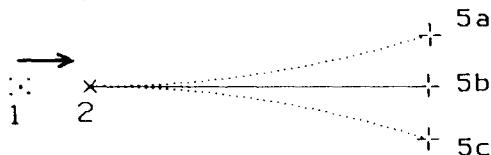

If you position the end-point exactly in line with the start direction, as 5b, you will draw a straight line. Any other end-points, as 5a or 5c, give curves as you would expect.

2.4.2 TANGENT ARCS AND LINES

You can mix arcs and lines together to draw almost any shape you like. Practice by reproducing the shape shown here in Figs 1-4, but don't worry at this stage if your results don't look quite the same. Read through the exercise before trying it.

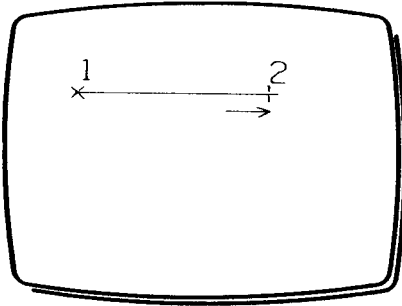

Fig 1

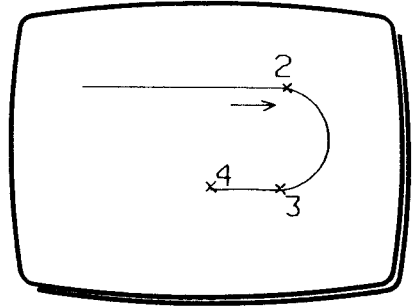

Fig 2

- 1 Clear the screen using WIPE (this also selects the straight lines drawing mode from the palette, bottom left corner).
- 2 Start the figure by moving XY to position the dynamic cursor at (1) in Fig 1.
- 3 Press and release L to position the origin cursor at the same point.
- 4 Move XY to position the dynamic cursor at (2) in Fig 1.
- 5 Press and release T to draw the line.
- 6 Select the TAN ARC symbol from the palette.
- 7 Move XY to move the dynamic cursor to (3) in Fig 2. Try to make an exact semi-circle.
- 8 Press and release T to draw the arc.
- 9 Select straight lines from the palette.
- 10 Move XY to move the dynamic cursor in a straight line from (3) to (4) in Fig 2.
- 11 Press and release T to draw the line.

S E C T I O N T W O

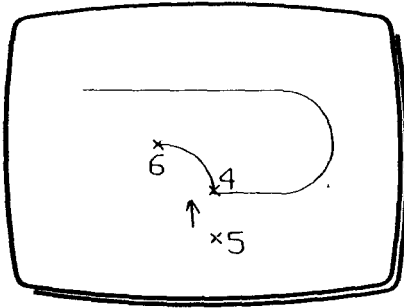

Fig 3

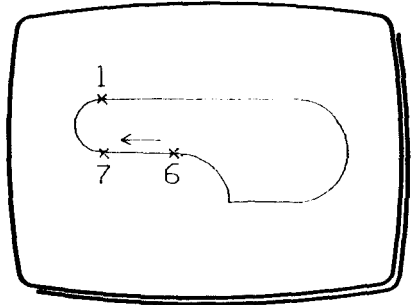

Fig 4

- 12 Select the TAN ARC symbol from the palette.
- 13 Move XY to position the dynamic cursor at (5) in Fig 3.
- 14 Press and release L to re-position the origin cursor.
- 15 Move XY to return the origin cursor to (4) in Fig 3.
- 16 Press and release L to re-position the origin cursor. You have now directed the arc inward.
- 17 Move XY to move the dynamic cursor to (6) in Fig 3.
- 18 Press and release T to draw the arc.
- 19 Select straight lines from the palette.
- 20 Move XY to move the dynamic cursor to (7) in Fig 4.
- 21 Press and release T draw the line.
- 22 Select the TAN ARC symbol from the palette.
- 23 Move XY to move the dynamic cursor to (1) in Fig 4.
- 24 Press and release T to draw the arc, and so complete the shape.

2.4.3 COMPASS ARCS - AUTOMATIC ARCS (2)

The second automatic arc mode allows you to define the centre point of an arc and fix its radius - great for concentric arcs, broken circles, and all the other things you would normally do with a compass.



Fig 1

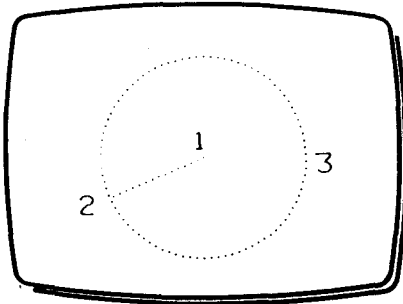

Fig 2

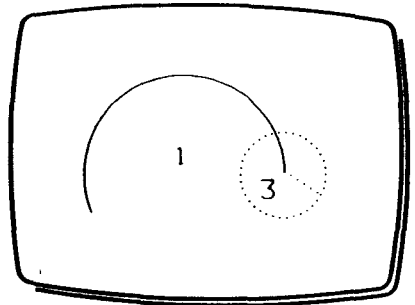

Fig 3

- 1 Clear the screen using WIPE.
- 2 Move XY to position the dynamic cursor at (1) in Fig 2.
- 3 Press and release L to position the origin cursor at (1) in Fig 2. This will be the centre point of the arc.
- 4 Select the COMPASS ARC symbol (1) in Fig 1 from the palette. A dotted cursor appears showing the radius and circumference of a circle centred on (1) in Fig 2.
- 5 Move XY to position the end of the radius cursor at (2) in Fig 2.
- 6 Press and release L to fix this radius.
- 7 Move XY to position the end of the radius at (3) in Fig 2.

SECTION TWO

- 8 Press and release T to draw the arc. The COMPASS arc cursor relocates at the end point of the arc just drawn, as in Fig 3.
- 9 Press and hold R and move XY down to the bottom left corner of the screen, to select the straight line mode and exit Compass Arc mode.

CONCENTRIC ARCS

When the arc has been drawn, the cursor will re-locate with (3) in Fig 3 as its centre. You may now fix another radius and draw an arc as before with this new centre or, more likely, you would wish to draw another arc centered on (1) in Fig 3.

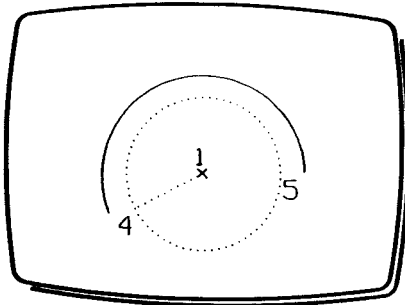

Fig 4

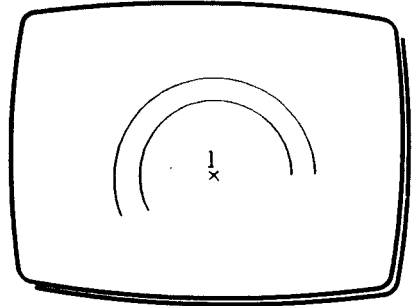

Fig 5

- 1 If you have not already done so, move XY down into the bottom left corner of the screen, then press and release R. This returns you to the straight line mode.
- 2 Select FIND on the Menu.
- 3 Press and release L or R to locate the centre point (1) in Fig 4. Press and release T when found.
- 4 Select the COMPASS ARC symbol from the palette. As before, a dotted cursor indicates the radius and arc of a circle centred on (1) in Fig 4.
- 5 Move XY to position the end of the radius at (4) in Fig 4.
- 6 Press and release L to fix the radius.
- 7 Move XY to position the end of the radius at (5) in Fig 4.
- 8 Press and release T to draw the second arc as in Fig 5.

SECTION TWO

Note: REVERSING THE DIRECTION OF ARC DRAWING

The compass arc is normally drawn in a clockwise direction but you can reverse this. Press and release L again after fixing the radius and the direction is changed. Try this out.

Note: To exit compass arcs at any time, move XY down into the bottom left corner of the screen and press and release R to select the straight line mode.

EXAMPLES OF COMPASS ARCS

Both the radius and angle of an arc can be set precisely using techniques described in the Precision Drawing Tutorials but for the present work by eye. For practice try experimenting with compass arcs, mixing them with lines and tan arcs. Some examples are shown here for you to copy.

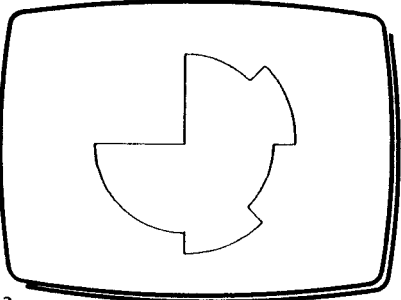
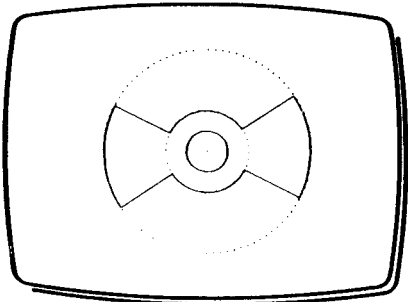
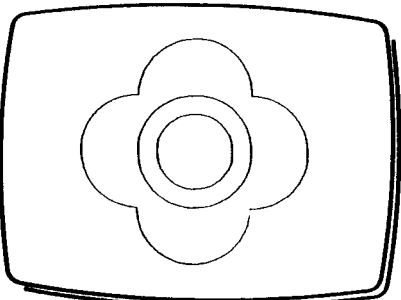
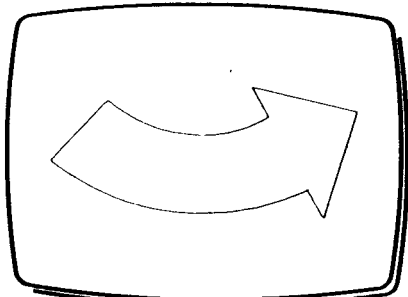
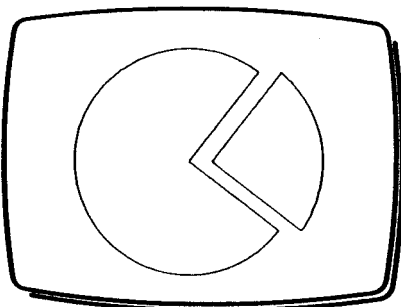
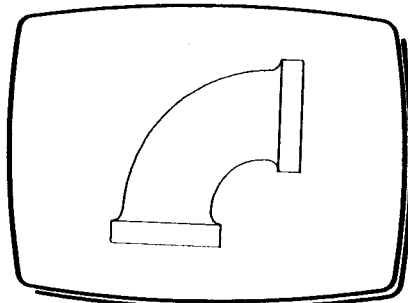

S E C T I O N T W O

2.5 TUTORIAL 5

This Tutorial gives exercises on the following topics.

Nib Drawing - a special kind of 'area' drawing

Angled Nib - using Nib in different orientations

Nib with Spacing - using Nib to get different drawing effects

Tracing drawings using the Controller

Adding Text to your drawings using two different methods

2.5.1 NIB DRAWING

An unusual, but very useful function of the system is NIB drawing. This allows you to draw with a variable width stroke and to fill in blocks of tone or colour, in a single action with the Controller.

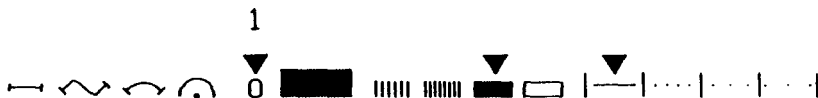

Fig 1

NIB SELECTION

To select the NIB mode move the dynamic cursor straight down to the '0' on the palette, see (1) in Fig 1. A white triangle will appear to indicate selection, move the stick vertically up to avoid changing the selection.

The cursor will change to a bright dot joined by broken lines to the start point (where the origin cursor was before you selected NIB). The width of the NIB can be altered by rotating Z.

You will see that one end of the NIB is marked with a small diamond. This is the 'active end', used like the dynamic cursor to make palette and menu selections.

S E C T I O N T W O

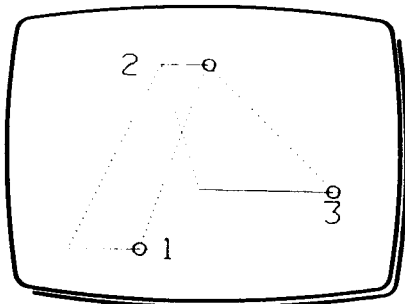

Fig 2

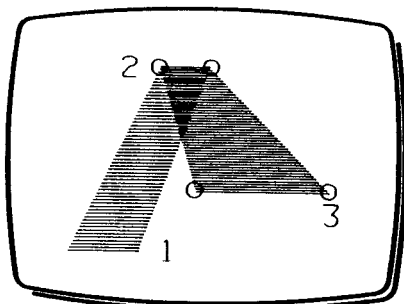

Fig 3

- 1 **Clear the screen using WIPE.**
- 2 **Select the NIB from the palette (see Fig 1).**
- 3 **Rotate Z to alter the width of the NIB, and move XY to position the NIB at (1) in Fig 2.**
- 4 **Press and release L to fix this as the new start position.**
- 5 **Rotate Z and move XY to position the NIB at (2) in Fig 2, the broken lines will show the area which will fill in when you draw.**
- 6 **Press and release T to draw the nib stroke.**
- 7 **Rotate Z and move XY to position the NIB at (3) in Fig 2.**
- 8 **Press and release T to draw another nib stroke. The screen should resemble Fig 3.**
- 9 **Exit from NIB by selecting LINE from the palette.**

Note: ERASE works with NIB as it does with lines, with one difference, all four corners of the nib stroke are marked

SECTION TWO

2.5.2 ANGLED NIB

You can change the angle of the NIB as well as its width.

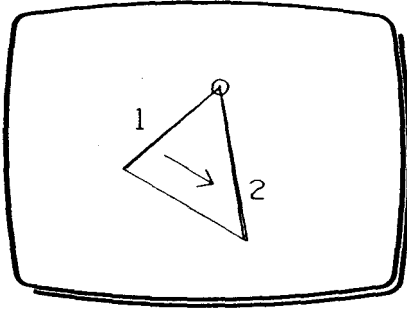

Fig 1

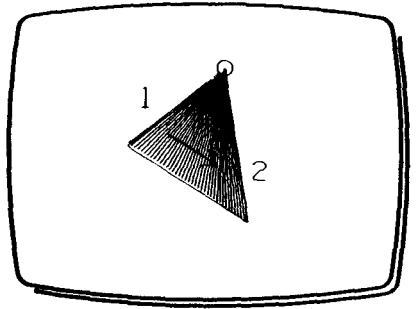
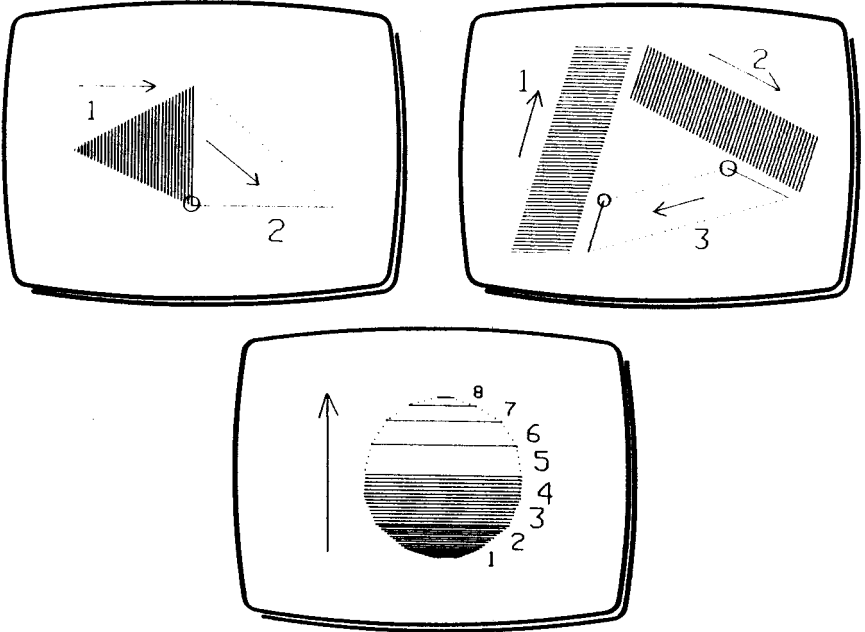

Fig 2

- 1 Clear the screen using WIPE.
- 2 Draw a medium size triangle, if the triangle is too large the NIB will not fit (see Fig 1).
- 3 Select NIB from the palette.
- 4 Press and hold R and rotate Z to alter the nib angle to match side (1) in Fig 1.
- 5 Release R to fix the nib angle (don't worry if the nib is too long).
- 6 Rotate Z to enlarge the nib to the length of side (1) in Fig 1.
- 7 Move XY to position the nib over side (1) in Fig 1, adjusting the nib length to fit it. Note that the small diamond should be at the top of the triangle.
- 8 Press and release L to fix this as the start nib position.
- 9 Press and hold R and rotate Z to alter the nib angle to match side (2) in Fig 1.
- 10 Release R to fix the angle, then rotate Z to adjust the nib width to fit side (2) in Fig 1. The small diamond should be at the top of the triangle.
- 11 Press and release T to draw the nib stroke, and so fill the triangle.

SECTION TWO

With practice, you will be able to fill most shapes with one or more nib strokes. Experiment with the examples shown here.



2.5.3 NIB WITH SPACING

So far we have used only a solid nib to fill areas. Now you can open out the nib stroke to produce a range of hatching or tone effects. There are six different nib spacings numbered from 0 (solid) through 5 (very spaced!). See Fig 1.

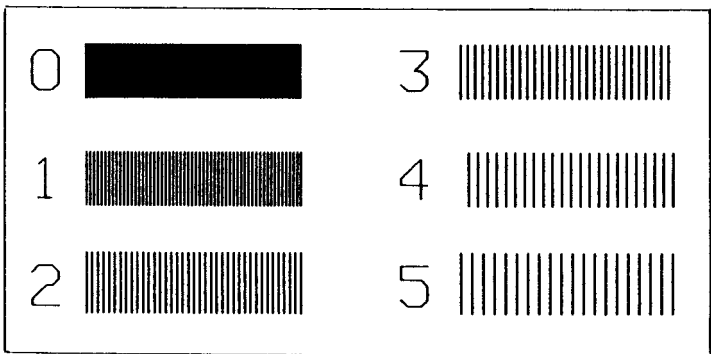

Fig 1

1 Clear the screen using WIPE.

S E C T I O N T W O

- 2 Move XY to move the cursor straight down to to the '0' on the palette, and hold it there.
- 3 Press and hold L and rotate Z to change the number to '2'.
- 4 Release L and move the stick vertically up, leaving a white triangle over the number. You may have to practice this a few times to become proficient.
- 5 To change the nib stroke, move XY to the white triangle, press and hold L, then rotate Z to change the number up or down.

Notice the the block to right of the number indicates visually the spacing you have chosen for the nib stroke.

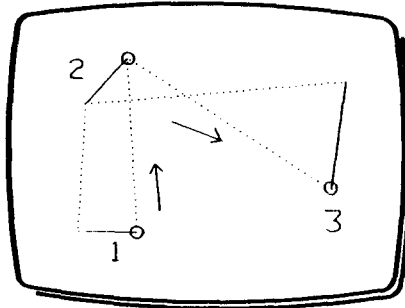

Fig 2

- 1 Clear the screen using WIPE.
- 2 Move XY to select NIB stroke, and a Nib spacing.
- 3 Rotate Z and move XY to position the nib at (1) in Fig 2.
- 4 Press and release L to fix the start position.
- 5 Rotate Z and move XY to position the nib (2) in Fig 2.
- 6 Press and hold R and rotate Z to fix nib angle.
- 7 Press and release T to draw a nib stroke.
- 8 Press and hold R and rotate Z to position the nib at (3) in Fig 2. Rotate the nib 180 degrees to achieve the 'twisted ribbon' effect shown.
- 9 Press and release T to draw the nib stroke.

SECTION TWO

Here's an unusual nib effect!

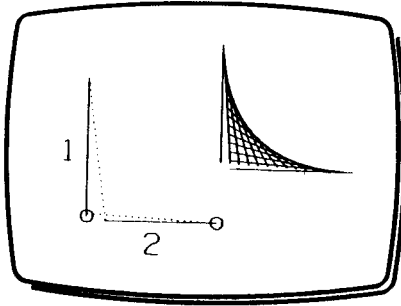
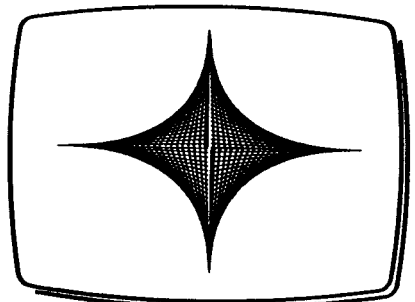
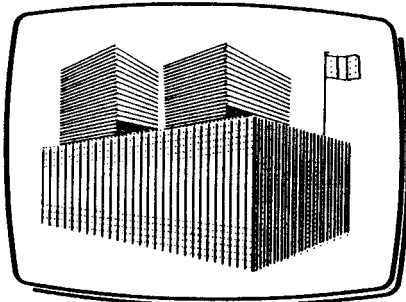

Fig 3

- 1 Clear the screen using WIPE.
- 2 Select NIB and set spacing to '3'.
- 3 Press and hold R and rotate Z to position the nib at (1) in Fig 3. Notice that the small diamond is at the bottom.
- 4 Press and release L to fix the start position.
- 5 Press and hold R and rotate Z to position the nib at (2) in Fig 3. The small diamond is now at the right.
- 6 Press and release T to produce an instant 'string picture'.

Other textures can be developed using nib spacings as above in combination with different line types selected from the palette.

Try the examples below.



SECTION TWO

You can use NIB to create all kinds of amazing effects! Try changing colours from the palette while you fill the screen with nib strokes of various spacings, angles and sizes. Then you can replay the whole thing in sequence by selecting PAGE. You can file the sequence in a library index box if you wish.

2.5.4 TRACE

You can trace existing artwork such as maps, logos, cartoons, photographs. You use a screen overlay made by intermediate tracing onto transparent film (a method which costs you hardly anything at all). Obtain a transparency such as you would use for overhead projection. See Figs 1 - 3.

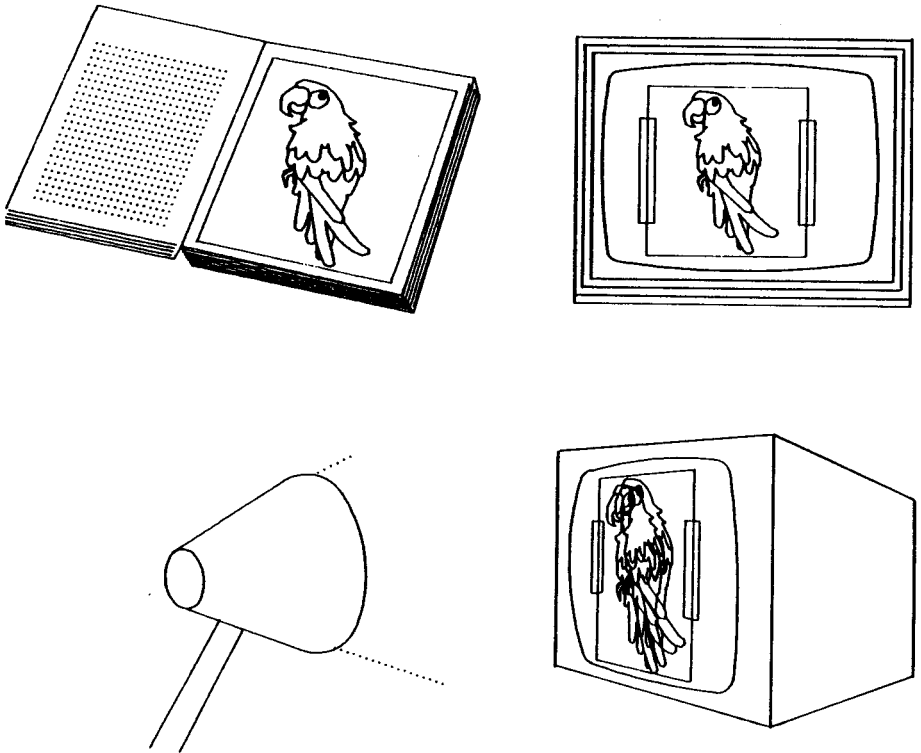

Figs 1 - 3

- 1 Using a strong black line, trace (or otherwise create) the desired outline on to the film, making sure it fits within the active area of the screen.

- 2 **Tape the film onto the screen.**
- 3 **Position a light source behind you, pointed at the screen. You will see a shadow of the drawn outline on the surface of the screen.**
- 4 **Trace the outline using the regular drawing cursors, pressing and releasing T as you go. In this way the outline is entered as a series of short lines or tan arcs.**
- 5 **You can FILE the drawing at any stage of completion.**

Complete a brief tracing and FILE it before going on to the next exercise.

2.5.5 **FREEHAND DRAWING**

The tracing technique described above is not the same as TRACE shown on Menu 1. When you select TRACE you can draw freehand on the screen using the 'stream' feature. The cursor changes to a dot under XY control.

As this method of drawing uses a lot of computer memory to store data, the system will warn you by beeping every time the Memory Counter reduces by 1000.

- 1 **Clear the screen using WIPE and then select TRACE. The cursor changes to a dot which can be moved XY to a start point.**
- 2 **Select a point to start drawing and press and hold T.**
- 3 **Move XY to draw a shape. When you release T, note the effect on the Memory Counter.**
- 4 **Exit TRACE by reselecting DRAW.**

Caution!: Freehand drawing consumes large amounts of memory and because of this the system gives an audible signal as a warning.

Once it beeps, the system is no longer accepting drawing input. To continue drawing, release T, use PAGE to redraw what has been stored and then reselect TRACE to continue drawing.

2.5.6 **TEXT**

The system handles text in a unique and powerful way. From the computer keyboard you can type dimensions, labels and notes for your drawings, or you can compose paragraphs and formatted blocks of text for page layouts, reports and forms. See Fig 1.

SECTION TWO

Text can be added to a drawing by either of two methods, (1) direct entry from the keyboard, or (2) copied from a library index box.

TEXT - DIRECT ENTRY

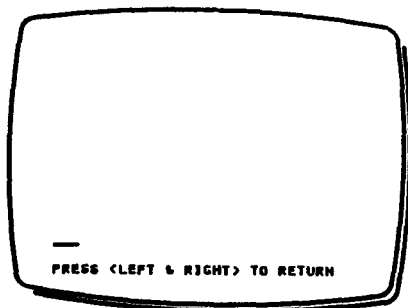

Fig 1

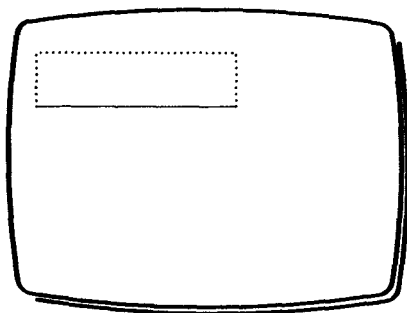

Fig 2

- 1 Clear the screen using WIPE.
- 2 Select TEXT from the Menu. The palette is replaced with an area for text entry, see Fig 1.
- 3 Type a name using upper and lower case letters, using SHIFT key. You can use DELETE key and the cursor control keys to assist in entering text.
- 4 Press and release L and R together to revert to the Work Page. The cursor changes to a frame cursor.
- 5 Move XY to move the box cursor into the Work Page, the box cursor defines the exact area the text will occupy at standard size.
- 6 Rotate Z to alter the size of the box. To avoid a medley of type sizes on a single drawing, only five choices are available, for this example choose two times standard size.
- 7 Position the box cursor as shown in Fig 2, making sure that none of the box is cut-off (i.e. outside the active area).
- 8 Press and release T to draw the text.
- 9 Don't clear the screen, as you will be adding to it in the next exercise.

Note: You can use other colours but you must first select the colour from the palette before selecting TEXT.

SECTION TWO

Note: To exit TEXT any time press and release L and R together.

Note: ERASE works with TEXT as it does with NIB.

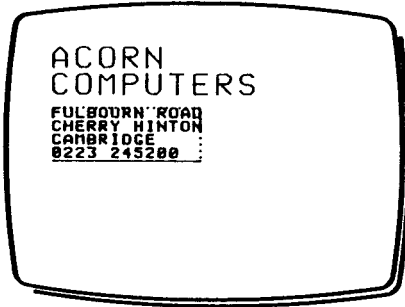

Fig 3

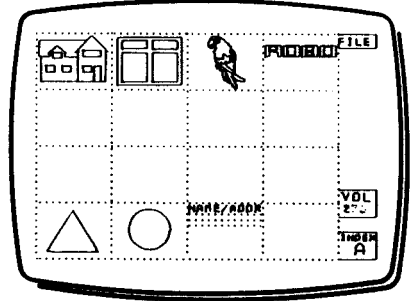

Fig 4

- 1 Select **TEXT** again.
- 2 Type in your address, this time press **RETURN** on the keyboard at the end of each line.
- 3 Press and release **L** and **R** together to revert to the Work page.
- 4 Move **XY** to position the cursor under your name. This time leave the box at standard size.
- 5 Press and release **T** to draw your address, as in Fig 3.
- 6 Select **FILE** from the menu, then place your name and address in an empty library box, as in Fig 4.

When filed, the text will appear in the index box as broken lines, because it is too small to display. For this reason, you would wish to label it (e.g. NAME/ADDR). The reason for this effect is explained below.

DISPLAY OF SMALL SCALE TEXT

Text entered at half and quarter-standard sizes will be displayed as dotted lines. However, the text is there even if you can't read it. You can make it reappear on the screen by enlarging the area using **ZOOM** function which is covered later on.

SECTION TWO

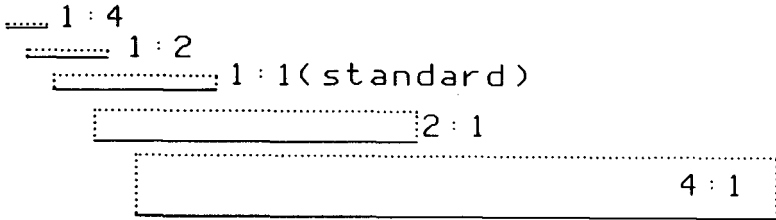

Fig 5 - The text cursor sizes (regular orientation)

As well altering the size of text, you can also place it in any of four orientations.

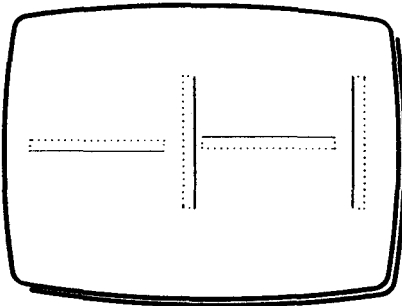

Fig 6

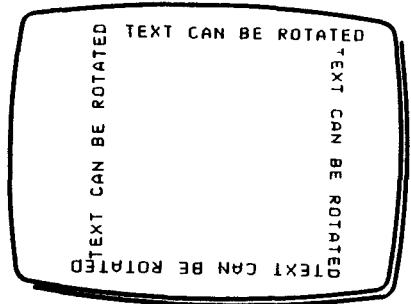

Fig 7

- 1 Clear the screen using WIPE.
- 2 Select TEXT.
- 3 Type in something e.g. 'TEXT CAN BE ROTATED'.
- 4 Press and release L and R together to revert to the Work page.
- 5 Press and hold L and rotate Z to rotate the box cursor, the solid line defines the bottom of the text. See Fig 6 for the different rotations possible.

- 6 Press and release T to draw the text in the chosen orientation, as in Fig 7.

Repeat the above instructions to enter text at different orientations.

2.5.7 TEXT - COPYING FROM LIBRARY

Copying from the library gives greater flexibility!

Direct entry text, is purposely limited in choice of size and orientation. However, with this method you can draw text at any size, rotation and proportion by filing it in the library, then copying it to the Work page. This is a unique method of text generation giving you unlimited choice of type style and size. The copying technique is also useful when you need multiple repeats of a particular label or paragraph.

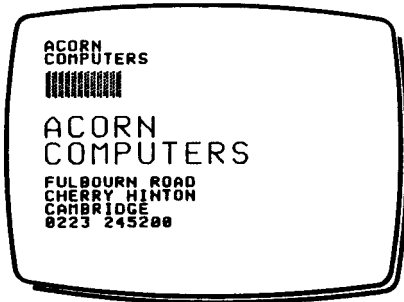

Fig 1

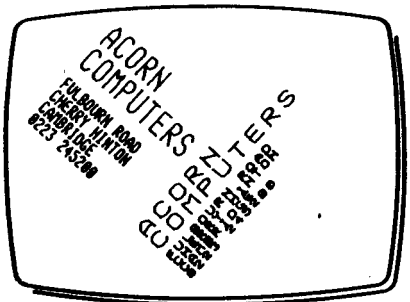

Fig 2

- 1 Clear the screen using WIPE.
- 2 Select COPY from the Menu.
- 3 Position the cursor frame at the index location containing your name and address.
- 4 Press and release T to select it,
- 5 When the work page re-appears, you can position and alter the cursor frame in the normal way for any COPY unit, as you have previously learned, using SCL ROT and STR.
- 6 Plant the text at different sizes, rotation and proportions to see various effects, (see Figs 1 and 2).

S E C T I O N T W O

Note: ERASE any of the planted text blocks as you would any other copied picture units.

Once text has been filed, you cannot edit it (this is a graphics system, not a word processor!). You can however, re-type the text, then 'over-file' it in the previous library location, this will automatically substitute new text for old wherever it may have been used on the same library disk - a very powerful facility.

At this stage we are working freeform to get some idea of the potential of copied text. This technique, using predrawn library units, can be used to produce neat, consistent text layout in a variety of sizes and modified fonts.

MIRROR IMAGE AND COLOURED TEXT

For mirror image text use FLIP

For coloured text use the colour override facility

These features are covered in the next tutorial.

2.6 TUTORIAL 6

Tutorial six covers several very sophisticated features of the system which allow you immense flexibility in the way you approach a drawing task. The following features are introduced.

- Zoom - expanding detail in your drawing
- Zoom and Pan
- Zoom with Library units
- Reversing Zoom
- Zoom View Storage
- Mirror images
- Changing Line Colour
- Changing Line Type

2.6.1 ZOOM

You have already seen that the system provides a very flexible repertoire of graphics facilities. However, you will also have noticed that the definition, or resolution of detail on the screen is somewhat limited. This is a feature of the computer's display system, but it does not limit the quality of drawings you can produce with the system. The reason for this, is a powerful magnifying (ZOOM) facility which enables you to add as much detail as you could possibly need!

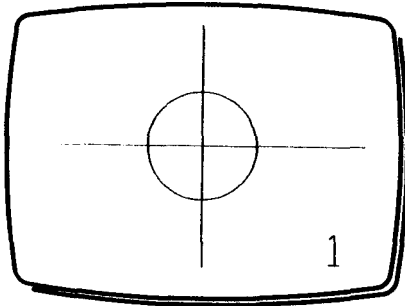

Fig 1

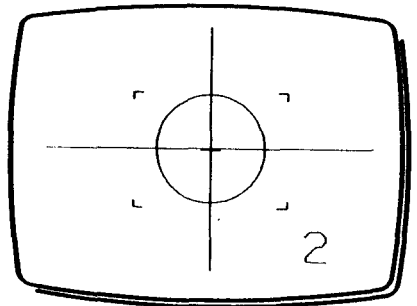

Fig 2

- 1 Clear the screen using WIPE.

SECTION TWO

- 2 Draw a figure similar to (1) in Fig 1.
- 3 Select **ZOOM** from the Menu.
- 4 Move **XY** and rotate **Z** to position the frame cursor over the circle, (2) in Fig 2, enclosing the circle closely.
- 5 Press and release **T** to enlarge the area. The page will clear, and the area defined by the frame cursor will be re-drawn, filling the screen.

You can now add more detail to the drawing, then re-display it at the original base page scale, as shown in the remainder of the exercise.

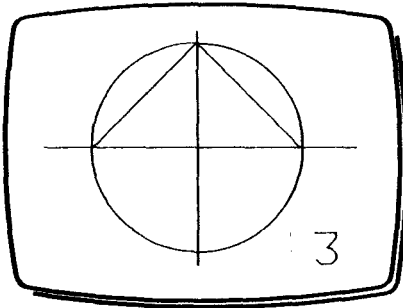

Fig 3

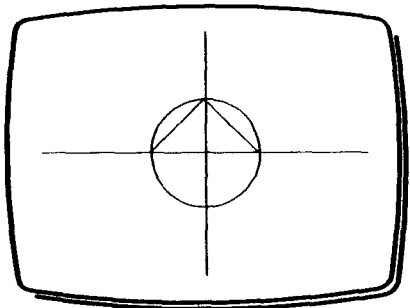

Fig 4

- 1 Exit **ZOOM** by press and release **L** and **R** together (this returns the system to **DRAW**, with the palette function you had selected before **ZOOM**).
- 2 Draw two lines as (3) in Fig 3. Note that it is easier to add the detail at this scale.
- 3 Select **PAGE** from the Menu. The drawing will re-appear at base page scale, and will include the added detail (Fig 4).
- 4 Do not clear the screen, it is used in the next exercise.

2.6.2 ZOOM & PAN

You can repeat **ZOOM** as often as you like, until you reach the maximum magnification, and then use a related function, **PAN**, to view off-screen areas of the drawing at that magnification (in effect **PAN** moves the 'screen window' around the drawing).

SECTION TWO

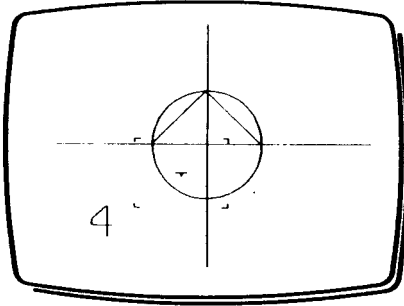

Fig 5

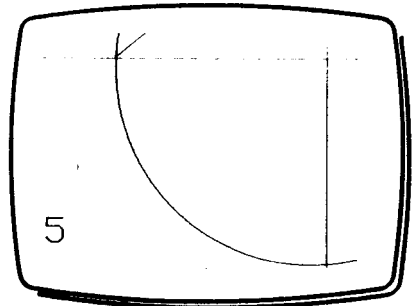

Fig 6

- 1 Select **ZOOM** from the Menu.
- 2 Move **XY** and rotate **Z** to frame a quarter of the circle with the cursor, as (4) in Fig 5.
- 3 Press and release **T**, and the framed area will appear full-screen, (5) in Fig 6.
- 4 Using the centre of the frame cursor, select **PAN** from the Menu. The cursor now on the screen is fixed at full screen size.

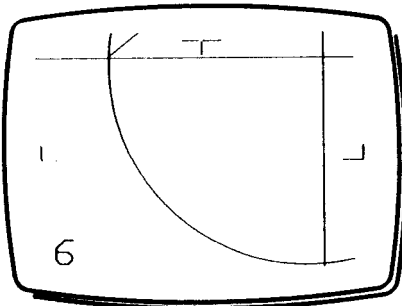

Fig 7

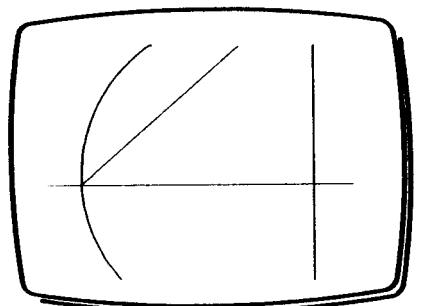

Fig 8

S E C T I O N T W O

- 5 **Move XY** to move the centre of the cursor to the top centre of the screen, (6) in Fig 7.
- 6 **Press and release T** to view the portion of the drawing enclosed by the PAN cursor, (Fig 8).
- 7 **Press and release L and R** together to exit PAN and ZOOM.

FAST PAN

If your drawing contains a lot of detail (more than simple example above), you can save time when panning repeatedly by suppressing the display. Just hit the keyboard space bar after each press and release of T. It can be used if you want to PAN several Work Page widths, unwanted intermediate views can be suppressed as soon as they are identified and a further PAN started.

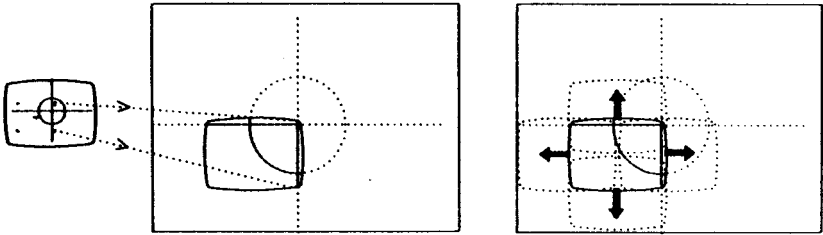

Fig 1

Fig 2

Effective base page after ZOOM.

Fig 2 - PAN shifts the 'magnifying lens' around the base page, in increments of up to one-half the screen width (or height, depending on direction).

As shown here, you can PAN repeatedly to view any part of the base page.

Note: If you try to PAN or ZOOM outside the Work Page boundary the system will beep and ignore the command.

2.6.3 ZOOM WITH LIBRARY UNITS

As well as using ZOOM to draw added detail, you can also plant whole library units at different magnifications. For practice use Index A of the Introductory Library Disk. This exercise has a large number of steps so read it through before you begin.

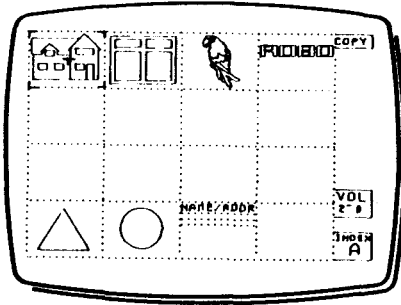

Fig 1

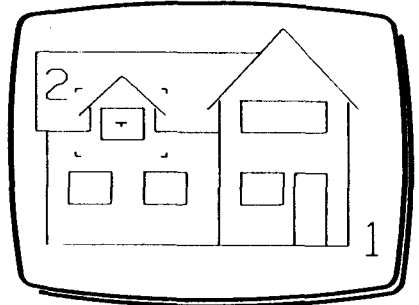

Fig 2

- 1 Clear the screen using WIPE.
- 2 Select COPY from the Menu, the Library Index page will appear (Fig 1).
- 3 Move XY to position the cursor frame over the house at top left.
- 4 Press and release T to return to the Work Page with the unit.
- 5 Move XY and rotate Z to adjust the cursor frame as in Fig 2.
- 6 Press and release T to plant the house at (1) in Fig 2.
- 7 Select ZOOM from the Menu using the centre of the Copy Cursor.
- 8 Move XY and rotate Z to position the cursor over the window as (2) in Fig 2.
- 9 Press and release T to draw an enlarged view of the window as in Fig 3.

SECTION TWO

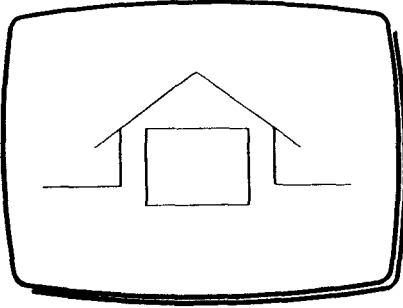

Fig 3

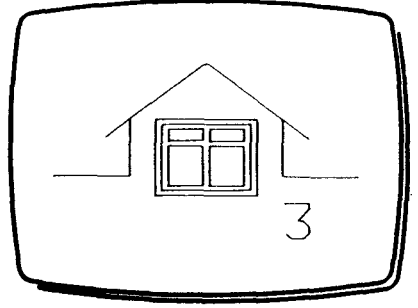

Fig 4

- 10 Select **COPY** from the Menu using the centre of the **ZOOM** cursor.
- 11 Select the window frame from the library index.
- 12 Press and release **T** to return to the Work Page.
- 13 Move **XY** and rotate **Z** to fit the cursor exactly to the window aperture.
- 14 Press and release **T** to draw the window frame as (3) in Fig 4.
- 15 Select **ZOOM** again.
- 16 Press and release **T** to draw an enlarged lower section of the window frame as in Fig 5.

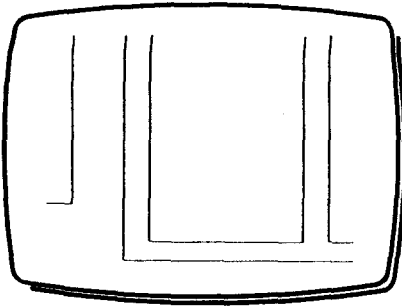

Fig 5

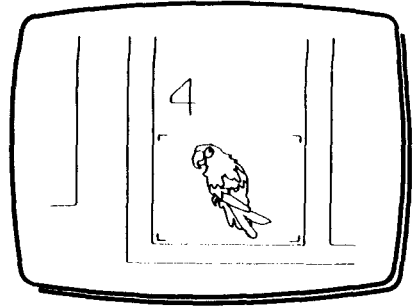

Fig 6

S E C T I O N T W O

- 17 **Select COPY.**
- 18 **Select the parrot shown in one of the library indexes.**
- 19 **Press and release T to return to the the Work Page.**
- 20 **Move XY and rotate Z to position the cursor as (4) in Fig 6.**
- 21 **Press and release T to draw the parrot.**
- 22 **Press and release L and R together to exit COPY.**

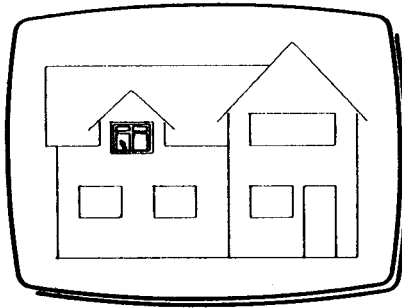

Fig 7

- 23 **Select PAGE from the Menu. The complete drawing will appear at base page scale, as in Fig 7. You can now zoom on another part of the house, adding details as you wish.**
- 24 **Select FILE from the Menu. Then save the drawing in an empty box.**

Note: This illustrates how you can assemble and file highly complex drawings with a minimum of effort.

For interest, you might wish to re-examine the detail you just added.

- 1 **Clear the screen using WIPE.**
- 2 **COPY the composite drawing back to the Work Page at any size and position.**
- 3 **ZOOM to take a closer look at the detail. You can make further additions if you wish, then re-save.**

SECTION TWO

2.6.4 REVERSE ZOOM

When looking at a zoomed view, you will notice that there is a point of rotation in which the zoom cursor frame is turned inside-out. In that condition, press and release T causes the current Work Page zoomed view to collapse to the size and position defined by the inverted frame, thus 'de-zooming' to the extent specified (See Fig 1).

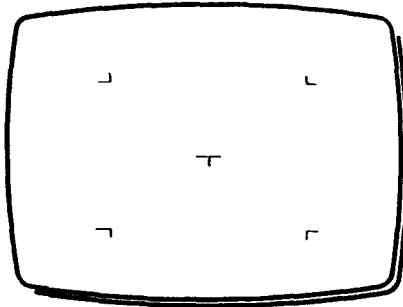

Fig 1

Note: If you attempt to 'de-zoom' off the boundary of the Work Page, the system will beep and ignore the command. Select PAGE to redraw the Work Page view.

2.6.5 ZOOM STORES

You cannot store a magnified (zoomed) view using FILE. If you try this the system automatically files the base page view, although the display remains at the zoomed view.

However, when changing detail in a drawing there is often a need to return several times to a particular zoomed view. You could do this by zooming down to the required level each time, but you would have to remember precisely which spot to focus on, and also the level of magnification.

To save time and eliminate uncertainty the system provides ZOOM STORES which allow you to store temporarily any two magnified views.

SECTION TWO

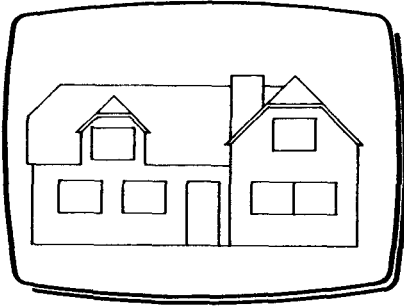

Fig 1

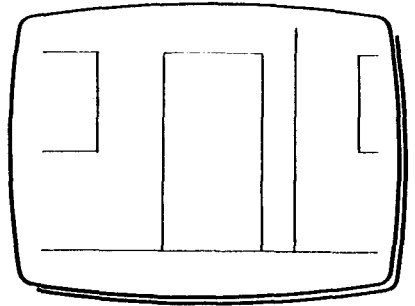

Fig 2

- 1 Clear the screen using WIPE.
- 2 COPY a library unit from the Library, for example, the house (Fig 1).
- 3 Select ZOOM to magnify a chosen detail, the door for instance (Fig 2).
- 4 Add detail in the form of some door panels (Fig 3).
- 5 Select UTILS from the Menu.

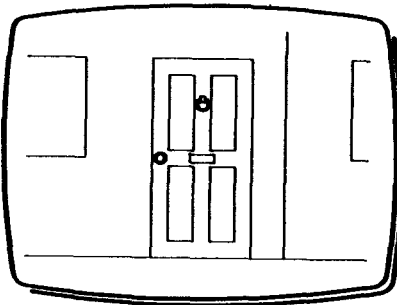

Fig 3

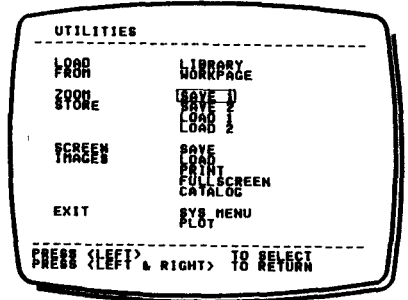

Fig 4

- 6 Move XY to select ZOOM STORE - SAVE 1 with the white bar, then press and release L to confirm. You have now stored that particular zoomed view.

SECTION TWO

The Work Page is redisplayed unchanged, and you can now continue in the usual way. You can use PAGE to display the whole drawing or PAN to move around the magnified area.

Any time you wish, you can quickly return to the original zoomed view that you just stored.

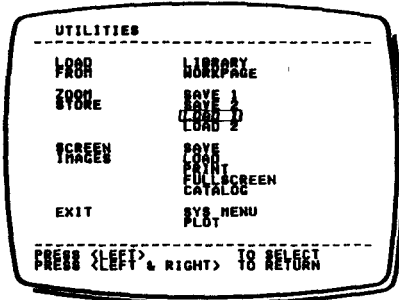

Fig 5

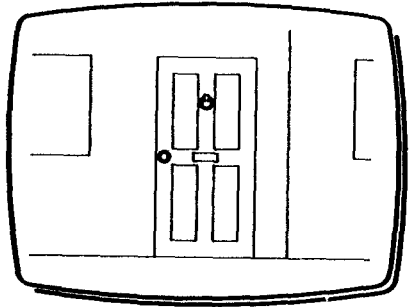

Fig 6

- 1 Select UTILS from the Menu.
- 2 Move XY to select ZOOM STORES - LOAD 1 as in Fig 5. Press and release L to confirm.
- 3 The stored, original, zoomed view returns to the screen with the drawing function previously selected.
- 4 Try modifying the retrieved detail (Fig 6). Additions to, or deletions from the 'loaded' zoom view automatically update the Work Page and ZOOM STORE 1, thus there is no need to store again after modification.
- 5 Select PAGE to return to the Work Page.
- 6 Select FILE if you wish to save this drawing.

Note: ZOOM STORE 2 functions in exactly the same way. You will find it convenient to use both zoom stores during a drawing session. It allows you to flip quickly from one view to another without going through PAGE and ZOOM each time.

Caution: ZOOM STORES 1 and 2 are stored in the memory, not on disk. They are lost when the computer is switched off. WIPE also clears the Zoom Stores.

SECTION TWO

2.6.6 COPY - MIRROR IMAGES

With the system you can FLIP any library unit copied from the library for instant mirror image effects.

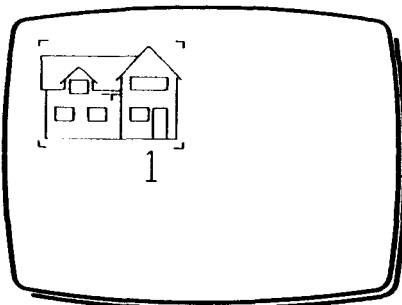

Fig 1

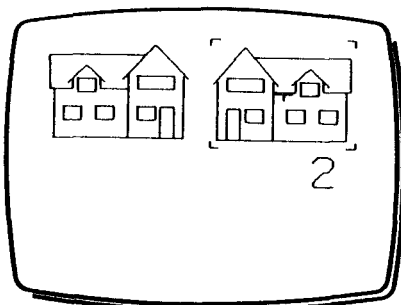

Fig 2

- 1 Clear the screen using WIPE.
- 2 Select COPY from the Menu.
- 3 Move XY to position the cursor frame over the house at top left of Library Index A.
- 4 Press and release T to return to the Work Page.
- 5 Rotate Z to reduce the size of the cursor frame to 30% (notice the value of the number SCL on the palette).
- 6 Touch SCL with the centre of the frame to lock this setting.
- 7 Plant the house at (1) in Fig 1.
- 8 Touch the 'X' of 'X FLIP Y' on the palette with the centre of the cursor frame to activate 'flipping' in the X axis.
- 9 Plant the house as (2) in Fig 2, the house appears as a mirror image of (1) about the vertical axis.
- 10 Touch the 'X' of 'X FLIP Y' to de-activate.

SECTION TWO

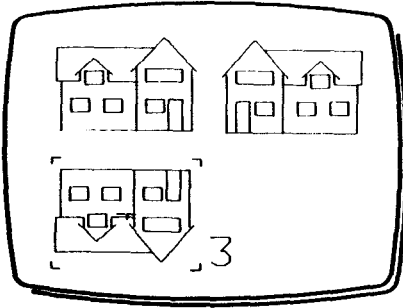

Fig 3

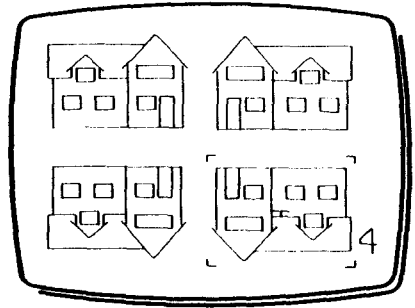

Fig 4

- 11 Touch the 'Y' with the centre of the cursor frame to activate the Y axis FLIP.
- 12 Plant the house as (3) in Fig 3. The house is now a mirror image of (1) about the horizontal axis.
- 13 Leaving 'Y' on, touch 'X' again.
- 14 Plant the house as (4) in Fig 4. The house is now mirrored about both vertical and horizontal axes.

Note: This last unit is the same effect as can be achieved with a 180 degree rotation of the frame with no FLIP functions engaged.

2.6.7 CHANGING COLOUR OF LIBRARY UNITS

To the right of 'X FLIP Y' on the Copy Palette you will see a white flag. When engaged, this indicates the colour of the library unit when it is planted.

The colour of the flag, and therefore the library unit, can be changed.

- 1 Clear the screen using WIPE.
- 2 Select COPY from the Menu.
- 3 Move XY to select your triangle from Index A.
- 4 Press and release T to return to the Work Page.

S E C T I O N T W O

- 5 **Move XY to locate the centre of the cursor frame on the colour flag on the palette, and hold it there.**

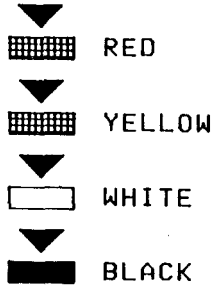

Fig 1

- 6 **Press and hold L and rotate Z to change the flag colour. Set it to yellow then release L.**
- 7 **Move XY to move the centre of the cursor frame up. A white triangle should appear over the flag (if not, touch the flag again with the frame centre).**
- 8 **Press and release T to plant a yellow triangle.**
- 9 **Do not clear the screen yet.**

Try repeating this procedure for several triangles of different colours.

2.6.8 CHANGING LINE TYPE OF A LIBRARY UNIT

You can also change the line type used when the library unit is planted.

- 1 **Touch the block to the right of the colour flag with the centre of the Copy Cursor frame, being careful not to set the other adjacent options.**
- 2 **Press and hold L and rotate Z to select a line type.**
- 3 **Plant the unit with different line types to see the effect.**

S E C T I O N T W O



Fig 1

PRACTICE WITH THE COPY PALETTE

Once you are used to the COPY palette, you will see that its powerful functions can save a great amount of time and effort, especially when assembling drawings from a number of similar modules.

2.7 TUTORIAL 7

This Tutorial introduces you to 'Editing' functions. These are functions which allow you to change or manipulate Library units within your drawings. The following topics are covered.

Moving library units about within drawings

Duplicating units

Swapping units over

Modifying a Library unit

Modifying a Work Page Unit

Exchanging a Single Library Unit

Global Exchange of a Library Unit

2.7.1 MOVE

You have seen in COPY and ERASE how library units are dealt with as whole units for planting in, or erasing from your drawings. This aspect is also used by another powerful feature of the system, the MOVE function. This allows you to move a unit from one part of your drawing to another very simply.

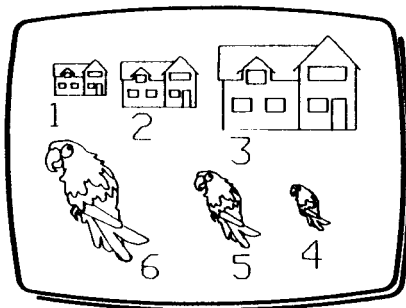

Fig 1

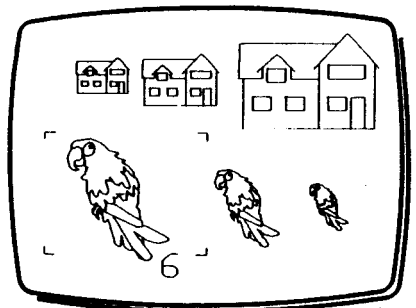

Fig 2

- 1 Clear the screen using WIPE.
- 2 Select COPY from the Menu and select any library unit from the library, placing it three times at separate locations on the screen, as (1) through (3) in Fig 1.

SECTION TWO

- 3 **Re-select COPY and select a different library unit from the library.**
- 4 **Place the new unit three times, as (4) through (6) in Fig 1. This simulates an assembly of library units such as you might have in a real project.**

Now we will use MOVE to manipulate the planted units.

MOVING UNITS ABOUT

With MOVE, you can both re-position a library unit and change its character completely, colour it, rotate it, stretch it, and more, using all the facilities of the Copy Palette.

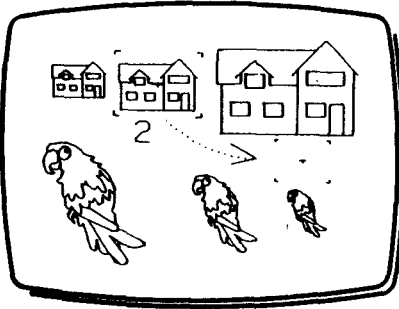

Fig 3

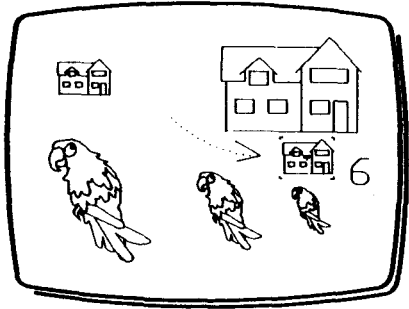

Fig 4

- 1 **Select MOVE from the menu. Menu 2 and the Copy Palette are displayed. A flashing frame cursor marks the last planted library unit, (6) in Fig 2.**
- 2 **Press and release L to step back through the planting sequence.**
- 3 **Press and release R to step forward through the planting sequence.**
- 4 **Press and release T when you have marked a unit you wish to move, the frame stops flashing, and a second cursor frame appears carrying (invisibly!) the marked library unit, as in Fig 3.**
- 5 **Move XY to move the second cursor frame to the desired new position. With this frame you have all the usual COPY controls (scale, rotation, stretch).**

SECTION TWO

- 6 Press and release T again, the original library unit is erased and re-drawn as defined by the movable cursor frame, as in Fig 4.
- 7 Press and release L and R together to exit MOVE then and select PAGE to redraw, but do not use WIPE.

Note: Until exit the MOVE function remains engaged, so you can move the same library unit again, using press and release L or R as before.

2.7.2 DUPLICATE

The DUPL facility allows any library unit copied onto the screen to be duplicated, no matter which library disk it came from. You can copy from a number of different library disks, taking one of each library unit you plan to use frequently in your drawing. The 'frequently used' library units can be planted at one side of the screen out of the way (in effect a temporary library), and the DUPL function can then be used to copy them as required.

A temporary library of symbols used like this can save you a lot of time, not to mention repetitive disk handling. Additionally, all functions of the COPY palette can be applied with DUPL.

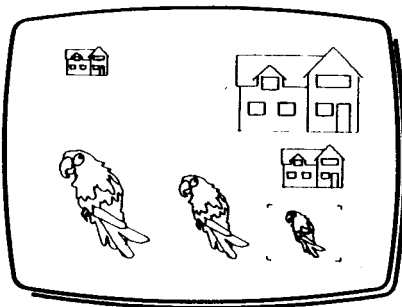

Fig 1

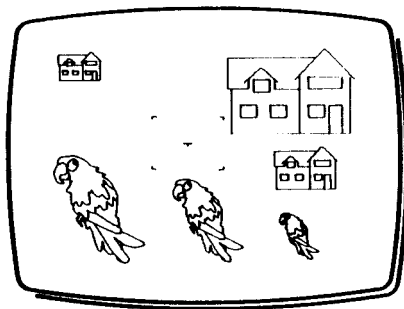

Fig 2

- 1 Select DUPL from the Menu. Menu 2 and the Copy Palette are displayed. A flashing frame cursor marks the last planted library unit (Fig 1).
- 2 Press and release L (step back) or R (step forward) through the planting sequence to choose your unit.

SECTION TWO

- 3 Press and release **T**. You now have a **COPY** cursor, with full functions, carrying a duplicate of the chosen library unit (Fig 2).
- 4 Press and release **T** to plant the duplicated library unit where required, as in Fig 3.

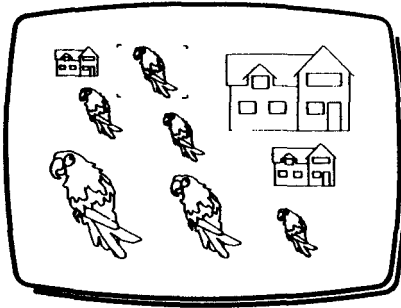

Fig 3

- 5 Press and release **L** and **R** to exit **DUPL**, but do not use **WIPE**.

2.7.3 EXCHANGE

This facility allows you to exchange any library unit on the screen for another library unit from any library disk. The incoming library unit from the library assumes exactly the original unit's characteristics, i.e. it will have the same position, scale, rotation, etc. You cannot set fresh conditions for **EXCH**.

EXCH is particularly useful for substituting symbols in a diagram, furniture or machine outlines on a ground plan, and text paragraphs on a page layout.

In addition, exchanged units retain the same slot in the planting sequence (and therefore replay sequence) as the original - an essential feature when changing elements in an animated sequence.

- 1 Select **EXCH** from the Menu, and the library index will appear (Fig 1).
- 2 Position the cursor frame at the location containing the desired replacement library unit.

SECTION TWO

- 3 Press and release T to confirm. The Work Page will re-appear with a flashing frame cursor marking the last library unit planted (Fig 2).

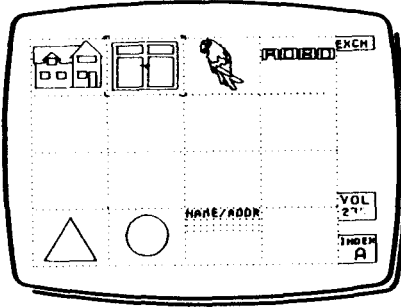

Fig 1

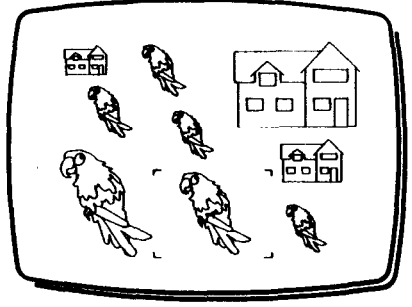

Fig 2

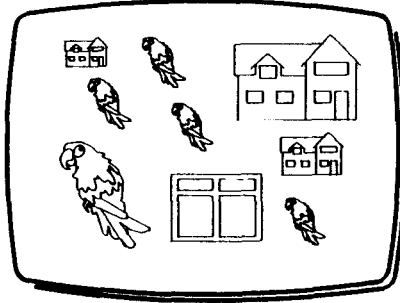

Fig 3

- 4 Step through the drawing using L and R to a unit to replace.
- 5 Press and release T. The marked unit will be erased and replaced by the library unit you chose from the library disk (Fig 3).
- 6 Press L and R to exit EXCH.

SECTION TWO

2.7.4 MODIFYING A LIBRARY UNIT

You will have noticed that when your drawing contains a unit copied from the Library using COPY, the unit is treated as an **complete entity** and not a collection of individual entries. For example, ERASE will take out the complete unit, when you might only wish to remove one particular line.

The UTILS function on the Menu provides a set of utilities which allow you to modify Library Units, as if they were normal Work Page drawings, plus other image handling tasks.

The next exercises illustrate the use of the utilities to modify and exchange Library Units.

MODIFYING A LIBRARY UNIT STORED IN THE LIBRARY

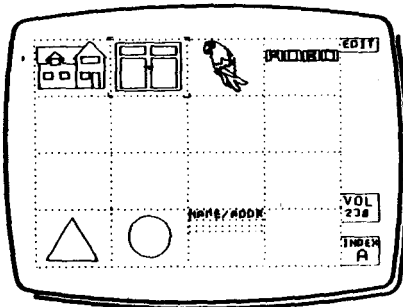

Fig 1

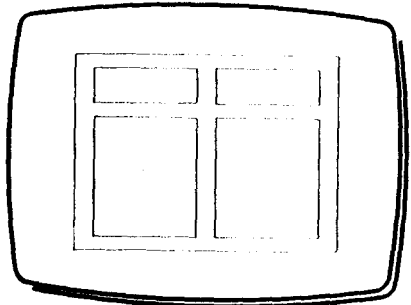

Fig 2

- 1 **FILE** the contents of the Work Page if you wish to save it. (the following procedure erases any material on the screen)
- 2 Select **UTILS** from the Menu and a list of options will appear.
- 3 Move **XY** to move the white bar to the top of the screen over the word **LIBRARY**.
- 4 Press and release **L** to confirm the selection, and the library index will appear (a **LOAD** flag appears at top right).
- 5 Position the cursor frame at the location containing the desired library unit.
- 6 Press and release **T**. The Work Page returns, and the chosen library unit appears at its original drawn scale and, unlike normal copied units, can be freely amended.

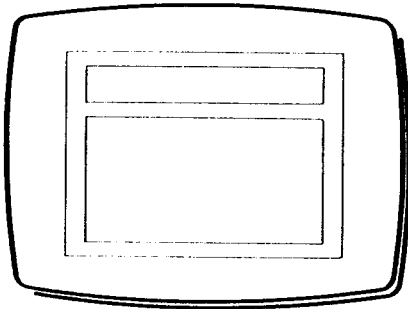

Fig 3

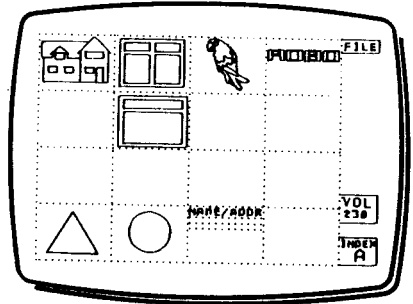

Fig 4

- 7 Now try erasing part of the drawing and then add new detail, (Fig 3).
- 8 FILE the modified drawing in an empty library location (Fig 4).
- 9 When the Work Page returns, modify the drawing again and re-file this third version. You can repeat this process as many times as you wish.

Note: All the normal drawing functions including ZOOM, ERASE, and FIND can be used. However, if the loaded Unit uses another Library Unit within it, that unit will be treated as a complete entity as normal. Detail within the embedded unit can be accessed using LOAD FROM WORK PAGE utility function illustrated in the next exercise.

2.7.5 MODIFYING A WORK PAGE UNIT

Library Units embedded in a drawing that require modification, can be modified without referring to the original Library Disk.

The LOAD FROM WORK PAGE utility function allows you to modify library units directly from the Work Page. Any unit on the Work Page can be selected, it is not necessary to have the original Library in the disk drive.

If the unit selected itself contains embedded units, and that embedded unit also needs modification the LOAD FROM WORK PAGE function can be used as many times as necessary to get back to the required detail.

S E C T I O N T W O

As with LOAD FROM LIBRARY, you should first FILE the Work Page if you want to preserve it, before selecting LOAD FROM WORK PAGE. This function WIPES the Work Page once the required unit has been selected.

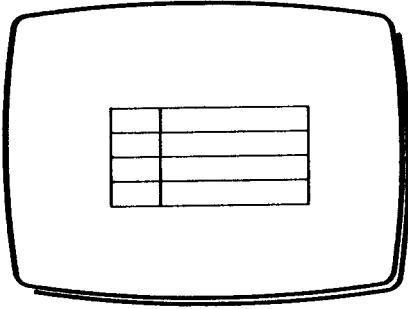

Fig 1

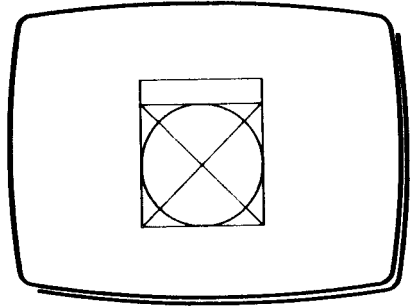

Fig 2

- 1 Draw, and then FILE the shape shown in Fig 1.
- 2 Clear the screen using WIPE.
- 3 Draw, and the FILE the shape shown in Fig 2.
- 4 Clear the screen using WIPE.

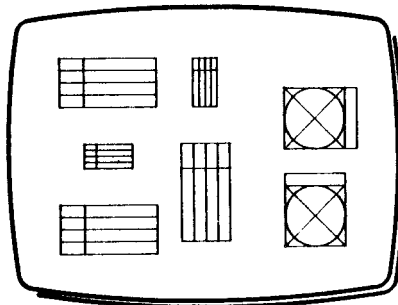

Fig 3

- 5 Copy both shapes on to the Work Page at various sizes and rotations (Fig 3).

S E C T I O N T W O

6 **FILE** the composite drawing in an empty box on the Library Disk.

Now an example composite drawing has been created, continue with the exercise by modifying the units with **LOAD FROM WORK PAGE**.

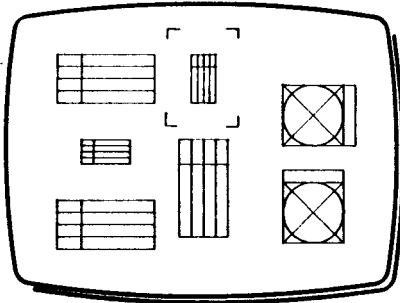

Fig 1

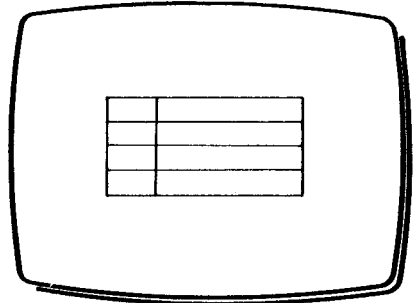

Fig 2

- 1 **Select UTILS** from the Menu.
- 2 **Move XY** to **LOAD FROM WORK PAGE**, press and release **L** to confirm. The Work Page is displayed with the cursor frame around the last library unit planted.
- 3 **Press and release L or R** to select a unit for modification (Fig 1).
- 4 **Press T** to confirm the selected unit. The unit is displayed at its original size and rotation (Fig 2). All other Work Page entries have been erased, hence the need to file the original composite drawing.

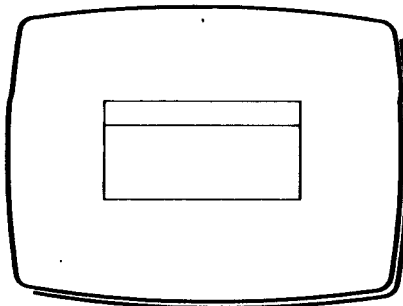

Fig 3

SECTION TWO

- 5 Remove a few lines from the drawing (Fig 3).
- 6 FILE the modified library unit in an empty box in the Library.

2.7.6 EXCHANGE SINGLE LIBRARY UNIT

Now you have learnt how to modify Library Units, both original Library Units, and units retrieved from the Work Page. If the original unit is included elsewhere, and must be replaced with the new modified unit, what do you do?

The UTILS functions provide the means to replace one Library Unit with another. There are two types of replacement possible. Single unit exchange, where one unit is selected and exchanged. Global exchange, where every occurrence of a particular unit on a Library disk is exchanged automatically.

SINGLE UNIT EXCHANGE

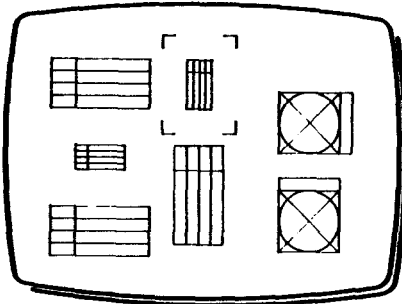

Fig 1

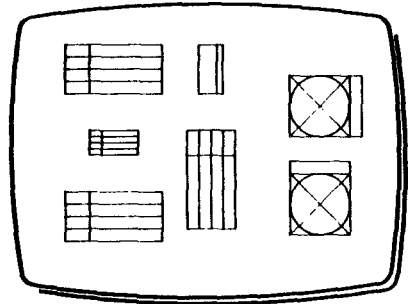

Fig 2

- 1 Select UTILS from the Menu, and move XY to select LOAD FROM LIBRARY. Press and release L to confirm.
- 2 When the Library is displayed, select the composite drawing previously created with the cursor, and press and release T.
- 3 After the drawing has been replayed, select EXCH from the Menu, and the Library Index is displayed.
- 4 Move XY to the modified unit you filed in the previous exercise, then press and release T to place it in memory (it is not displayed at this time).

S E C T I O N T W O

- 5 **The composite drawing reappears, with a cursor frame around the last unit planted (Fig 1).**
- 6 **Frame the top centre shape, then press and release T to confirm. The shape is erased and replaced by the modified unit, appropriately scaled, as in Fig 2.**
- 7 **Press and release L and R to exit EXCH.**

2.7.7 GLOBAL EXCHANGE OF LIBRARY UNITS

If you wish to exchange every occurrence of a Library Unit in a composite drawing, you can use the automatic editing procedure providing the Library Unit and composite drawing are on the same Library Disk.

To do this, you do not file the modified unit in an empty Library Index box, instead you replace the original unit by filing over the top of it with the modified version.

This is a very powerful feature! When you pull a unit out of a Library, modify it and then put it back in the same place, you will find that every other drawing or Library Unit which contains the newly modified unit, has been automatically updated to reflect the change!

How does automatic editing work? The component drawing is stored only once on the Library Disk (when you first FILE it), and subsequent use and re-filing of the same unit is done by reference to the initial filing not by creating a new set of data.

Caution: For automatic editing to work correctly, the component drawing and related assembly drawings must ALL be on the same Library Disk. Thinking about this when you organise libraries can save a lot of work later.

- 1 **Clear the screen using WIPE.**
- 2 **Draw the shape in Fig 1.**
- 3 **FILE the drawing in an empty library box.**

SECTION TWO

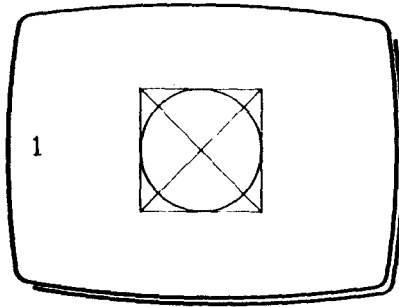

Fig 1

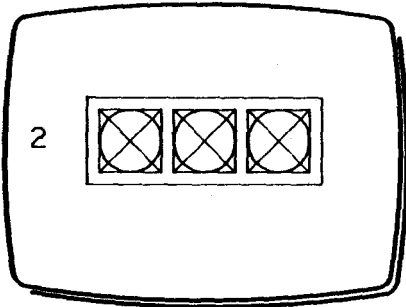

Fig 2

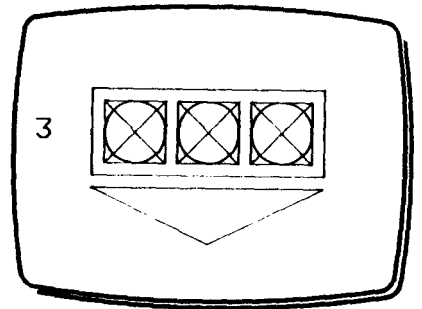

Fig 3

- 4 Clear the screen using WIPE.
- 5 COPY the drawing just filed
- 6 Add some lines to it as in Fig 2.
- 7 FILE it in an empty library box.
- 8 Clear the screen using WIPE.
- 9 COPY the drawing just filed.
- 10 Add some more lines to it as in Fig 3.
- 11 FILE it it an empty library box.

S E C T I O N T W O

You now have two stored Library Units based on a single component drawing. Now we will modify the that component drawing.

- 1 **Select UTILS from the Menu.**
- 2 **Move XY to LOAD FROM LIBRARY and follow the sequence you have learned to retrieve your original drawing from the Library Index.**
- 3 **Alter the drawing as in Fig 4.**

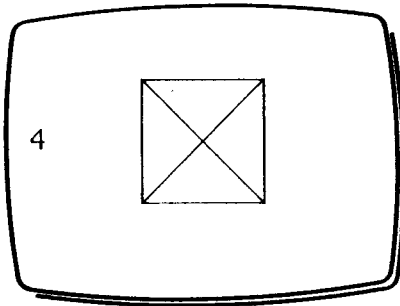

Fig 4

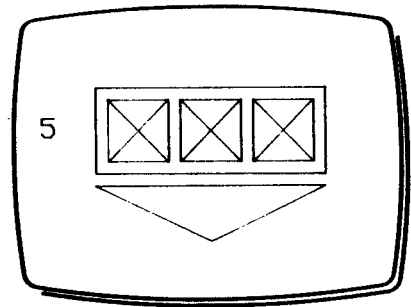

Fig 5

- 4 **FILE the drawing INTO THE LIBRARY INDEX BOX IT CAME FROM.**
- 5 **Clear the Screen using WIPE.**
- 6 **Using COPY, check that the composite drawing now uses the modified component (Fig 5).**

Caution!: The Library Index is not updated, so the modifications will not be visible there. To update the Library Index, use LOAD FROM LIBRARY then FILE, to recreate the Index entry.

RECURSION - A TRAP FOR THE UNWARY!

You have seen that a Library Unit is stored only once on a given Library Disk. If it is used in another drawing, the system recreates the unit by referring to the initial filing instead of generating a new set of data.

This means, for example, a composite drawing assembled using a unit from Index A - Box 14, cannot be filed back to box A14 on the same Library Disk. That would mean an attempt to store in A14 a drawing which needs the original contents of A14, which would obviously be destroyed by the composite drawing.

S E C T I O N T W O

This is 'illegal' to the system, and is known as RECURSION. If this situation occurs the message 'Illegal File' will be displayed by the system.

If you wish to file over the top of a unit with a modified version of itself, DO NOT USE COPY, use LOAD FROM LIBRARY from the Utility functions.

This particular procedure removes the identifying codes from the unit, causing the system to handle it as new data in all respects.

S E C T I O N T W O

2.8 TUTORIAL 8

Tutorial eight deals with functions related to the screen display. Depending on the hardware equipment you have available, try as many of these exercises as you wish. The topics covered are as follows.

Saving a Screen Image as a 'snapshot' onto disk

Recalling a Screen Image previously stored

Printing a Screen Image on a printer

Full screen presentation

Photographing a Screen Image

Video recording the Screen Image

2.8.1 SAVING AN IMAGE

You have learned all the basic drawing functions during these tutorials, and have no doubt drawn and filed some impressive pictures along the way. Now it's time to explore some of the things you can do with your art work.

You have seen how a drawing filed on the library disk can be handled as a re-usable unit . An important point here is that a drawing stored in the library using the FILE function is not stored as an image, but rather as a set of data instructions the computer uses to recreate the drawing by reconstructing it on the screen.

The system provides a second means of storing pictures on **normal pre-formatted disks**. This storage method is called **SAVE**.

- 1 Draw or COPY a picture on to the screen.
- 2 Remove the Library Disk from Drive 0 and insert a normal pre-formatted disk.
- 3 Select UTILS from the Menu, and list of options will appear.
- 4 Move XY to move the white bar to the word SAVE.
- 5 Press and release L to confirm the selection. You will be asked to give the image a name.
- 6 Type a name of your choice, then press RETURN. The image will be saved to the disk.
- 7 Press and release L and R to return to the Work Page.

S E C T I O N T W O

The image has been stored as a complete entity - actually a mosaic of dots exactly as they appeared on the screen (this is called a bit map). Because the image has been stored as a single unit, it cannot be manipulated using COPY or ZOOM functions. However, it can be recalled (instantly!), modified and used in other ways.

2.8.2 RECALLING AN IMAGE

Having saved an image you need to know how to get it back on to the Work Page. Ensure your 'image disk' is still in Drive 0.

- 1 **Clear the screen using WIPE.**
- 2 **Select UTILS from the Menu, and a list of options will appear.**
- 3 **Move XY to move the white bar to the word CATALOG.**
- 4 **Press and release L to confirm. A list of all named images on the disk will appear**
- 5 **Note the name of the image you wish to recall.**
- 6 **Press and release L and R together to return to the list of options.**
- 7 **Move XY to move the white bar to LOAD.**
- 8 **Press and release L to confirm. You will be asked to name the image to be recalled. (If you already knew the image name you could have gone directly to LOAD).**
- 9 **Type the name, then press RETURN.**
- 11 **Press and release L and R to return to the Work Page.**

Note: All the normal drawing functions - including text - can now be used to alter the image. For instance, you can erase whole areas using a black nib, and you can make free-hand additions using TRACE.

Note: Although the image is on the screen, there is **no data in memory**, so selecting PAGE will not redraw the image, but you can add detail to the image and save it again.

CATALOG

All the images that you save are listed on the Image Catalog. You can select CATALOG from the UTILS menu to get a list of the saved images at any time.

S E C T I O N T W O

You also have the option of deleting any unwanted images by pressing T and entering the image name.

TRY DELETING THE IMAGE YOU HAVE STORED BY SELECTING CATALOG AND FOLLOWING THE SCREEN DISPLAY.

2.8.3 PRINTING AN IMAGE

The system includes automatic facilities for printing ('dumping') the image on an appropriately equipped dot matrix printer (Section 1). The printer reproduces the image as a dot mosaic exactly as it appears on the screen (coloured areas appear as tone patterns on a monochrome printer).

- 1 **Switch on the printer, set to ON-LINE, and load it with paper.**
- 2 **DRAW or LOAD an image onto the screen.**
- 3 **Select UTILS from the Menu, a list of options will appear.**
- 4 **Move XY to move the white bar to the word PRINT.**
- 5 **Press and release L to confirm.**

Note: The image is printed without Menu and palette.

2.8.4 FULL SCREEN PRESENTATION

For photographic and other direct-from-screen applications, the image can be automatically enlarged to fill the entire display, eliminating the menu and palette.

- 1 **DRAW or COPY a picture onto the screen.**
- 2 **Select UTILS from the Menu, a list of options will appear.**
- 3 **Move XY to move the white bar to the word FULLSIZE.**
- 4 **Press and release L to confirm. The image will be re-drawn full screen size.**

There's no menu, so now what? Press the T button to go directly to SAVE IMAGE (i.e to save the image without Menu or Palette), or press L and R to return to the UTILS display.

S E C T I O N T W O

2.8.5 PHOTOGRAPHING AN IMAGE

Special photographic units are available for recording the screen image on 35 mm slides or instant prints. Most such units are expensive and are intended for professional use.

However, very acceptable results can be achieved by photographing the display screen with an ordinary camera. Photo quality depends on many factors, including ambient light level, monitor performance and choice of film.

2.8.6 VIDEO RECORDING AN IMAGE

Whatever appears on the screen can be recorded direct onto videotape, this applies equally to static images (such as title pages) and dynamic replay sequences.

The video output is available in three forms from the computer, either direct (Composite Video), RGB, or UHF video. However, the Composite Video is monochrome only.

Some attenuation of the signal may be necessary depending on the choice of video recorder and interface. Questions on these matters should be referred to your dealer.

2.9 TUTORIAL 9

Tutorial nine is the first tutorial which deals with the Precision Drafting functions available with the system from Menu 2, which you have not previously used. This first tutorial covers general points you need to know for the remaining tutorials.

An Introduction to Precision Drafting

Lock Functions

Escaping from a Lock

Using WIPE in the Lock condition

Cancelling a Lock Condition

2.9.1 INTRODUCTION TO PRECISION DRAFTING

You've seen in earlier tutorials how the system can be used as a powerful sketching, or freehand drawing tool. But that's really only the beginning. You have at your disposal a range of precision aids which can be used with the same effect as the traditional graph paper, scales, protractors and other drawing instruments.

These precision aids are available through Menu 2, which you saw in Tutorial 1 (Sect 2.1). You will find them essential if you intend to create your drawings to a high technical standard. End points will be accurately defined, lines will meet where they are supposed to, curves will blend smoothly, parallel lines will be just that, and text will be consistent in size and position. With the precision aids on Menu 2 you will find that your drawing jobs go faster, with less repetition than before.

2.9.2 LOCK FUNCTIONS

Menu 2 provides lock functions which control movements of the drawing cursor in specific ways, depending on the type of lock you have selected. For example, you could position the cursor precisely at any chosen point on the Work Page, or you could make the cursor move only along a particular line, at any chosen angle.

There are two general types of lock, ANGLE and GRID. Each has a wide range of possible settings. The two locks can be used separately, or in combination, to set a skewed, or isometric grid.

With Menu 2 on the screen, you can still access all the palette functions you used in freehand drawing. However, if you have engaged a lock function from Menu 2, you cannot change a menu or palette selection without first suppressing the lock condition.

S E C T I O N T W O

Why are we telling you this before you have even seen a lock?

Because, literally , you can lock yourself into a condition where you can't do anything else unless you know how to get out of it!

2.9.3 ESCAPING OR TEMPORARILY SUPPRESSING A LOCK

If any lock function is in effect, the cursor cannot move freely outside the Work Page to make Menu and palette selections. To free the cursor, you must first press and hold the right hand button on the controller (press and hold R).

Then you can move XY to select the desired function on menu or palette, and then release the button (Release R). Releasing R has the effect of 'arming' the lock system again. When you move the cursor away from your menu or palette selection, you will find that the lock is re-armed.

For Menu selections , you release R, then confirm selection in the usual way by press and release L. Here is a summary:

LOCK SUPPRESS/FUNCTION SELECT

Unlock	Press and hold R
Select	Move XY to menu/palette
Arm	Release R
Confirm	Press and release L (Menu only)

2.9.4 WIPE IN THE LOCK CONDITION

The above procedure works for WIPE too, the only difference being that to confirm WIPE you press and release L and T together. The lock is automatically cancelled by WIPE, which is in effect a general system reset.

2.9.5 CANCELLING A LOCK CONDITION

Lock cancellation is similar to suppression, with one difference, to select 'cancel' you return the cursor to the LOCK indicator, which is already engaged. Release R, then switch off the lock by pressing L. Here is a summary:

LOCK CANCEL

Unlock	Press and hold R
Return	Move XY to lock flag
Arm	Release R
Cancel	Press and release L

Remember these details of Lock Suppression and Cancellation. You may need them!

S E C T I O N T W O

2.9.6 FREEHAND DRAWING WITH A LOCK ENGAGED

You can draw 'unlocked' with any of the lock functions engaged. With DRAW selected, holding down R will unlock the cursor, allowing it to be moved. To draw, press and release T while continuing to hold down R, then release R. The Draw function will be executed as soon as R is released. Here is a summary:

- 1 **Ensure that DRAW is selected.**
- 2 **Press and hold R to free the cursor.**
- 3 **Move XY to the position desired.**
- 4 **While still holding R, press and release T to draw.**
- 5 **Release R to execute the DRAW function.**

The TRACE cursor is always unlocked while actually drawing, (T held down). To TRACE from an unlocked origin:

- 1 **Ensure TRACE is selected.**
- 2 **Press and hold R to unlock the cursor.**
- 3 **Move XY to the start position desired.**
- 4 **While still holding R, press and hold T.**
- 5 **Release R, still holding T, to draw.**

This may seem a little complicated, but with use you will become familiar with the sequence. However, remember you can always switch a lock off, draw unlocked, then switch it on again.

S E C T I O N T W O

2.10 TUTORIAL 10

Tutorial ten covers the features and uses of Angle Locks.

Vernier Angle Locks

Coarse Angle Locks

Four Axis Locks

Orthogonal Locks (ORTH)

Normal Tangent Locks (N-TAN)

2.10.1 VERNIER ANGLE LOCKS

This lock constrains the cursors to move only in two fixed 'grooves' originating at the origin cursor.

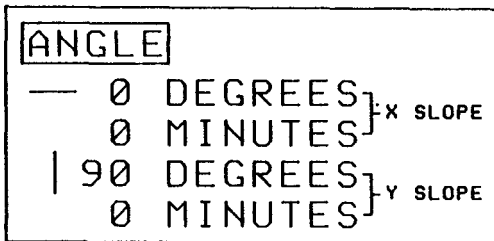

Fig 1

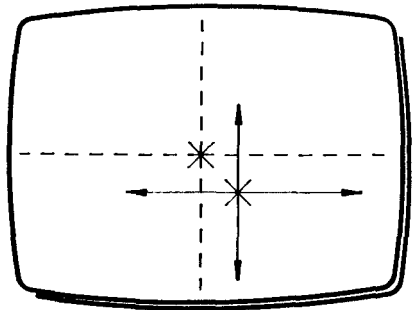

Fig 2

- 1 Clear the screen using WIPE.
- 2 Select Menu 2.
- 3 Move XY and press and release L to switch on the top ANGLE flag (Fig 1).
- 4 Now try moving XY, the cursor can move only along two axes passing through the origin cursor (Fig 2).

The angle of each axis, referred to the horizontal, is displayed on the menu. In the 'default' state (which is what you selected above) the X (East-West) axis is at 0 degrees, 0 minutes, and the Y (North-South) axis is at 90 degrees, 0 minutes. Later we will change these angles, but first we try drawing with the lock engaged in the default state.

SECTION TWO

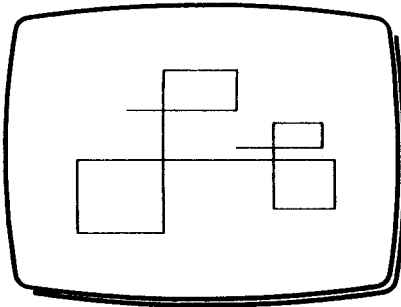

Fig 3

- 1 Move the dynamic cursor away from the origin cursor, then press and release L to shift the lock origin (i.e. the origin cursor).
- 2 Draw a number of lines and boxes as in Fig 3. They are all perfectly right angled, which is a very useful feature, don't worry if the joins are not exact - there is another lock function for this.
- 3 Press and hold R to unlock the cursor, then move XY to move the cursor freely. Press and hold L, release R, then release L to reposition the origin cursor.

Note: So long as R is held down, the cursor can be moved anywhere on the screen, including the Menu and palette.

Now try setting the axes at different angles.

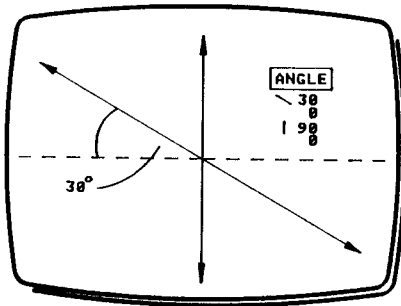

Fig 4

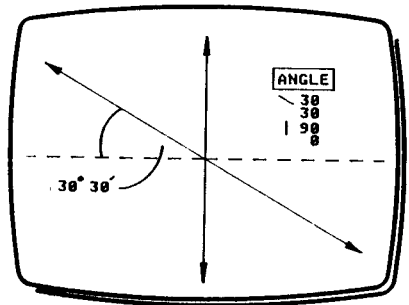

Fig 5

SECTION TWO

Change degrees of the X axis

- 1 Press and hold R, move XY to the X degrees flag immediately beneath the ANGLE legend, then release R.
- 2 Keeping the flag lit, press and hold L, then rotate Z to alter the slope about the horizontal from 45 degrees (fully clockwise) through 45 degrees (fully counter clockwise). Set the angle to 30 degrees, then release L.
- 3 The cursor returns to the locked axes, which are now at 30 and 90 degrees as in Fig 4.
- 4 Now draw a few more lines.

Now change minutes of the X axis,

- 1 Press and hold R, move XY to the X minutes flag, then release R.
- 2 Keeping the flag lit, press and hold L, then rotate Z to fine tune the slope from 0 to 59, set the angle to 30 minutes, then release L.
- 3 The locked axes are now at 30 1/2 degrees and 90 degrees (Fig 5).

The Y axis lock acts on a similar way, with a range 45 to 45 degrees about the vertical - try changing it for practice.

2.10.2 COARSE ANGLE LOCKS

The vernier lock you have just tried is used whenever your drawing or construction requires degrees-and-minutes precision. The second angle group down on the menu provides a coarse lock for less critical applications.

- 1 Switch off the vernier angle lock by moving XY to the ANGLE flag and pressing L once.
- 2 Set the angles of the coarse lock to X = 20 degrees and Y = 70 degrees (Fig 1).
- 3 Switch on the Coarse ANGLE flag. The cursor is now locked (Fig 2).
- 4 Try drawing with the coarse angle lock.
- 5 Now switch back to the vernier lock. The coarse lock is automatically switched off when the vernier lock is re-engaged.

SECTION TWO

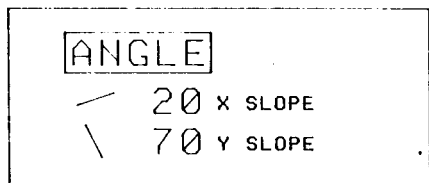

Fig 1

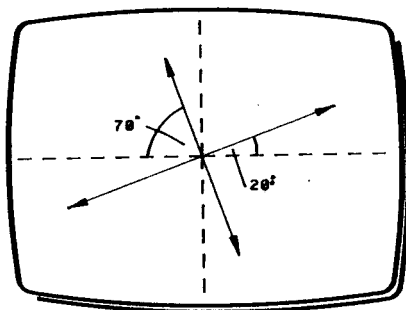

Fig 2

2.10.3 FOUR AXIS LOCK

Because you can alternate between coarse and vernier locks at anytime, there are effectively four presettable lock axes - two in degrees and minutes and two in degrees only.

2.10.4 ORTHOGONAL LOCKS (ORTH)

This lock works just like the coarse or vernier angle locks, with one difference - it is not adjustable. ORTH provides convenient one-shot selection of 0 and 90 degree lock axes, and is routinely used for outlining rectangular structures.

2.10.5 NORMAL TANGENT LOCKS (N-TAN)

This function automatically senses the slope of the last line drawn, then sets an orthogonal axis lock at the end of the line.

With this lock engaged, you can draw either a smooth continuation of the previous line, or a line normal to it (i.e. at right angles).

N-TAN is especially useful for smoothly blending curves into straight lines, (compare this with the TAN ARC, which works the other way, i.e. TAN ARC blends a straight line or arc into an arc).

SECTION TWO

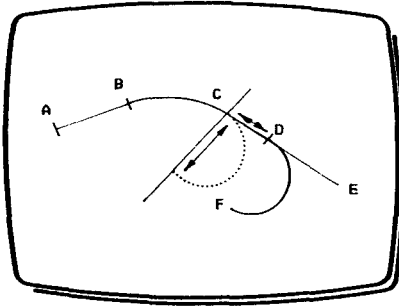
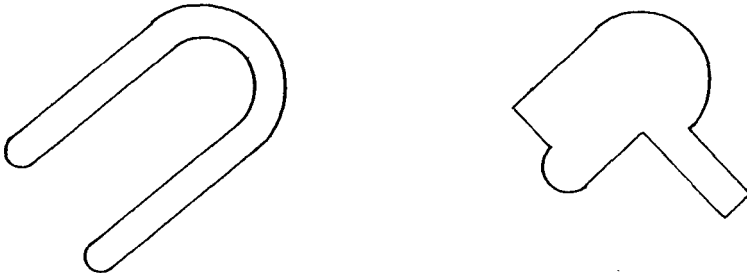

Fig 1

- 1 Clear the screen using WIPE from Menu 1.
- 2 Draw a short straight line, (AB) in Fig 1, at any angle.
- 3 Select TAN ARC from the palette.
- 4 Draw an arc, (BC) in Fig 1, blending with the line. Now select LINE from the palette.
- 5 Select Menu 2, then select N-TAN. Notice how the cursor now moves along the tangent to the arc, (giving a straight line), or at right angle to tangent, (giving a perfect semicircle).
- 6 Press and release T to draw the straight line (CD) in Fig 1.
- 7 The N-TAN lock now operates from its new origin, i.e. the end of the line you just drew, allowing you to draw a straight line continuation (DE), or the semicircle (DF), in Fig 1.

N-TAN is a very powerful function, much used in more advanced drawing. Try constructing the examples below.



SECTION TWO

2.11 TUTORIAL 11

This Tutorial introduces another series of functions to create and dimension grids to assist in drawing. The following topics are covered.

Locked Grids

Grid display

Grid Size

Using a Grid

Changing the Grid Spacing

Changing the Grid Position

Rotating the Grid using N-TAN

Rotating the Grid to an Unknown Angle

Setting a Skewed Grid with X and Y

2.11.1 LOCKED GRIDS

A variety of grids can be displayed on the screen as aids to precision drafting, just as you would use a transparent ruled overlay or graph paper. The grid appears as a matrix of 'lock points' on the Work Page.

When a grid is engaged, the cursor can no longer move freely about the screen, instead it jumps from lock point to lock point, and cannot go anywhere else. This makes it very easy to draw with zero error to and from the accurately defined nodes of the grid - something you will appreciate when you make precision drawings, and notice that lines supposed to meet at a point do exactly that!

2.11.2 GRID DISPLAY

The screen display is itself a grid - a fine mesh to be sure, but a grid just the same. If you draw a vertical straight line you will see that it isn't continuous, but instead is a column of individual points, called pixels. On the display there are 320 columns of pixels, and 256 rows. However, 32 of these columns are needed for the system menu, so the active work page is 288 across (the X dimension) by 216 down (the Y dimension).

By convention we number these starting from the top left corner of the screen.

SECTION TWO

Grid divisions

When you draw freehand, the cursor can be moved freely to any pixel on the Work Page. With a grid in place, however, the cursor can move only to those pixels coinciding with lock points of the grid.

Because the grid divisions in the X and Y directions can be set independently, the grid cells can be made square, or rectangle in any proportion. You can choose any value for the X and Y divisions from 4 through 32 pixels.

2.11.3 GRID SIZE

How many divisions can you have across the Work Page?

This depends on the grid value you choose, but it's one less than you might think!

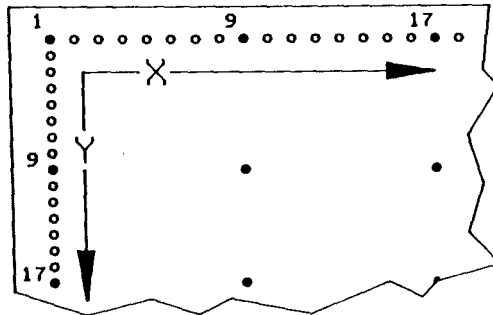

Fig 1 - Lock Points on the 8 pixel grid

For illustration we'll assume an X value of 32 pixels, with the origin (the first lock point) in the top left corner. Counting 32 pixels to the right of the origin we come to second lock point, after 32 more the third, and so on.

However, because the first pixel marks the origin, the second point is actually on the 33rd pixel, and the tenth point would be on the 289th pixel, outside the Work Page boundary.

This means we cannot have more than 9 points, or 8 divisions across the page with the grid value 32, the same math applies down the page - 216 pixels, 6 divisions.

SECTION TWO

2.11.4 USING THE GRID

Because the X and Y axes can be assigned different values, there is a wide choice of orthogonal grids. Additionally, the X and Y axes can be set at different angles, so literally millions of grid possibilities are available to you!

We will explore these variations later, but here we start with an orthogonal 32 pixel grid.

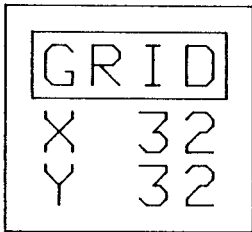

Fig 1

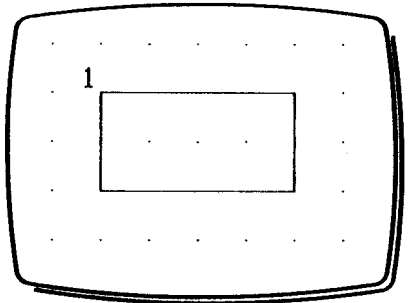

Fig 2

- 1 Clear the screen using WIPE. Notice that the origin cursor is in the centre of the Work Page. Leave it there for the present.
- 2 Select Menu 2.
- 3 Move XY to illuminate the GRID flag and press and release L to switch it on (Fig 1). A locked 32 x 32 grid appears on the work page in register with the grid origin, the origin cursor.
- 4 Move XY and press and release L to position the origin cursor at (1) in Fig 2, and draw a rectangle.
- 5 Continue drawing lines between lock points for practice.
- 6 Press and hold R to unlock the cursor, then move XY to the GRID flag. Switch the GRID flag off by releasing R, then press and release L. The grid disappears, leaving small holes in your drawing where the lock points were.
- 7 Select Menu 1, then select PAGE to replay the drawing without holes.

2.11.5 CHANGING THE GRID SPACING

The X and Y grid values can be altered independently anytime you wish. You can choose any number between 4 and 32, but note that 4, 8, 16 and 32 are preferred values because they allow magnified views to be displayed without requiring the grid origin to be shifted.

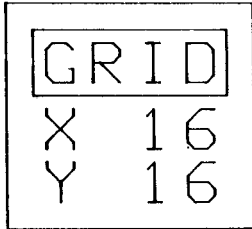

Fig 1

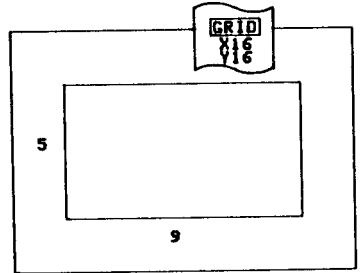

Fig 2

- 1 Clear the screen using WIPE.
- 2 Select Menu 2.
- 3 Move XY to light the X 32 flag. Press and hold L and rotate Z to change the X value to 16, release L and move XY away to confirm the new setting (Fig 1).
- 4 Move XY to light the Y 32 flag. Press and release L, the value will change automatically to 16. If a different number is required, press and hold L, rotate Z to set 16, then release L and move XY away to confirm.
- 5 Move XY to light GRID flag, then press and release L to confirm. A 16 x 16 grid then appears on the Work Page.
- 6 Draw a rectangle 9 x 5 units in size. as in Fig 2.

Now set a smaller grid, allowing you to quarter the rectangle (which you cannot do with the 16 x 16 grid).

- 1 Press and hold R to unlock the cursor, then move XY to light the X 16 flag, and release R. Press and hold L, and rotate Z to display the value 8, then release L.

SECTION TWO

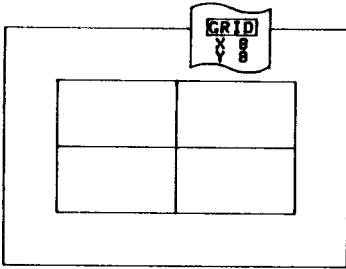

Fig 3

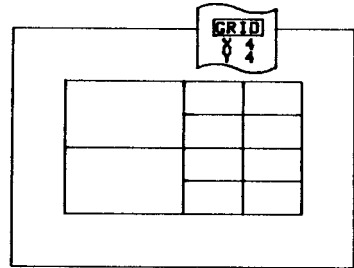

Fig 4

- 2 To set the Y value to 8, move XY to the Y flag, then press and release L. The value should change automatically to 8. If a different value is required, press and hold L, rotate Z, then release L and move XY away to confirm.
- 3 To change the grid, press and hold R, move XY to the GRID flag, release R, then press and release L to cancel previous grid.
- 4 Now, with the GRID flag still flashing, press and release L to switch it on again, the grid then appears at the new 8 x 8 spacing.
- 5 Draw in the centre lines of the rectangle (Fig 3).
- 6 Reset the X and Y values to 4, reset the grid to the new spacing and halve the rectangles again (Fig 4).
- 7 To cancel the grid, press and hold R, move XY to the GRID flag, release R, then press and release L.
- 8 Select Menu 1, then select PAGE to replay the drawing without holes.

Note: Before changing grid size in the above procedure, make sure the origin cursor is at one of the rectangle corners. If you've shifted the origin cursor accidentally, the grid will be shifted to a new origin, probably out of register with the rectangle. If this happens you can re-locate the origin on the rectangle using FIND.

SECTION TWO

2.11.6 CHANGING THE GRID POSITION

You can alter the position of the grid by planting the origin cursor at the point you want the grid to originate from, then switching the GRID flag on. One of the grid's lock points will coincide with the origin.

Two ways of Changing Grid Position

The origin cursor can be planted in one of two ways.

Manually, anywhere on the Work Page.

Using FIND to locate the end of a line.

MANUAL POSITIONING

The example below uses manual shifting of the origin cursor, together with grids of different spacings, to produce ruled lines at any desired position.

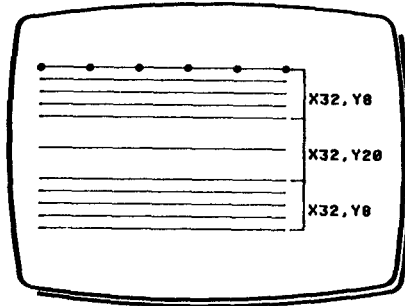

Fig 1

- 1 Clear the screen using WIPE.
- 2 Select Menu 2, set the Y grid value to 8, leaving the X value at 32.
- 3 Switch the GRID flag on.
- 4 Draw five equally spaced lines near the top of the Work Page, as in Fig 1.
- 5 Reset the Y grid value to 20.
- 6 Switch the GRID flag off, then on again. One lock point of the 32 x 20 grid which now appears coincides with the last position of the origin cursor.

SECTION TWO

- 7 Draw a line 20 pixels down from the last line.
- 8 Draw a second line 20 pixels further down.
- 9 Reset Y grid value to 8.
- 10 Switch the GRID flag off , then on again, to re-display the 32 x 8 grid.
- 11 Draw a further four lines 8 pixels apart, to complete the drawing shown in Fig 1.

Note: In this example the X value remains at 32 throughout, but you could change this anytime. You could also try setting a grid to a point not related to a previously drawn line, switch the grid off, plant the origin cursor anywhere you wish, then switch the grid on again.

AUTOMATIC POSITIONING USING FIND

This second technique is very often used to make precise joins to any previously drawn end points. You will find it a most useful procedure to use.

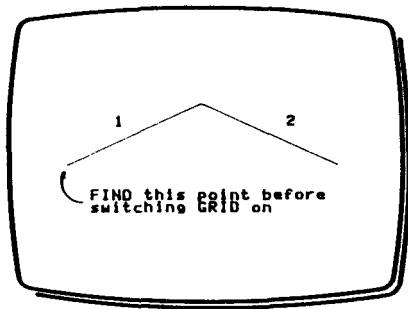

Fig 2

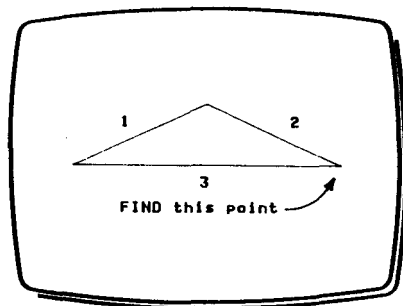

Fig 3

- 1 Clear the screen using WIPE.
- 2 Draw two lines, as (1) and (2) in Fig 2.
- 3 Select FIND from the Menu and press and release L to locate the start of line (1). Then press and release T to plant the origin cursor at this point.
- 4 Select Menu 2.

S E C T I O N T W O

- 5 Switch the GRID flag on. Notice that one of the lock points of the grid now displayed coincides with the end of the line (1).
- 6 Press and hold R, and select Menu 1. Select FIND, release R, then press and release L.
- 7 The FIND cursor now marks the end of line (2). Press and release T to plant the origin cursor.
- 8 Move XY to position the dynamic cursor at the free end of line (1), at a lock point.
- 9 Press and release T to draw line (3) in Fig 2. Notice that all corners of the triangle are perfectly joined.

REMEMBER

'FIND and GRID SHIFT' is an essential routine for precision drafting.

2.11.7 ROTATING THE GRID USING N-TAN

Here we use the N-TAN lock to rotate the grid, and so align it with a previously drawn line.

Note: The lock points on the rotated grid are spaced by an amount equal to the indicated values (e.g. X32 x Y32) only along the axes of the grid, not the horizontal or vertical.

This means that you can use the grid as a scale to measure the length of lines at any angle - a very useful feature with many applications.

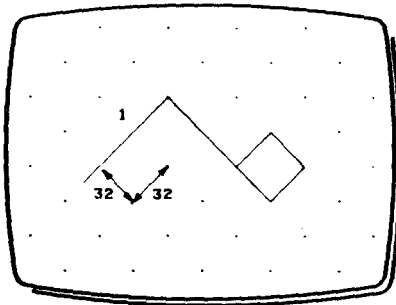

Fig 1

S E C T I O N T W O

- 1 **Clear the screen using WIPE.**
- 2 **Draw a line at random as (1) in Fig 1.**
- 3 **Select Menu 2.**
- 4 **Select N-TAN, the cursor now locks onto two axes. In line with (1) in Fig 1, and at right angles to it.**
- 5 **Switch the GRID flag on. A 32 x 32 grid appears at the angles set by the N-TAN lock. Notice that the cursor is still locked to the angle axes, not the grid lock points.**
- 6 **Switch N-TAN off, the cursor is now locked to the grid.**
- 7 **Draw lines on the GRID, they will all be parallel or at right angles to the original line if the appropriate grid points are used.**

You can use this procedure at any time to set a grid to a line you have just drawn. Provided you re-engage N-TAN before turning the first grid off, you can quickly set another grid at the same angle but with different spacing.

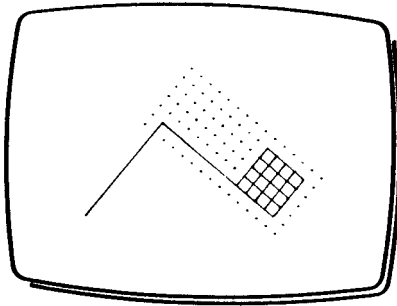

Fig 2

- 1 **Switch N-TAN on again.**
- 2 **Switch the GRID flag off and reset the X and Y values to 8, then switch the GRID flag on again. An 8 x 8 grid is now displayed at same angle as the former 32 x 32 grid.**
- 3 **Switch N-TAN off to lock the cursor to the grid.**
- 4 **Now draw several lines using the new grid as in Fig 2.**
- 5 **Switch the GRID off, but do not clear the screen.**

SECTION TWO

You have now 'lost' the grid angle, but you can recover it anytime using the ZOOM and FIND procedure in the next exercise.

2.11.8 ROTATING THE GRID TO AN UNKNOWN ANGLE

You can set an angled grid to any previously drawn line, using ZOOM and FIND to fix the angle. We will use the drawing you have on the screen from the previous exercise.

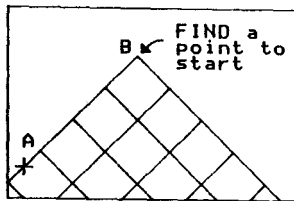

ZOOM and FIND

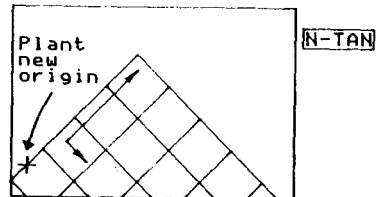

Plant origin and switch on N-TAN

Fig 1

Fig 2

- 1 Select ZOOM, then enlarge a portion of a selected line, (AB) in Fig 1, to include an end-point.
- 2 Exit from ZOOM.
- 3 Select FIND, and locate the selected end-point of the line, then press and release T to plant the origin.
- 4 Move XY to move the dynamic cursor back along the selected line as far as it will go, thus superimposing the cursor line on the drawn line. This condition is indicated by the two lines cancelling out, leaving no line.
- 5 Press and release L to re-plant the origin, fixing the angle of the line (Fig 2).
- 6 Select Menu 2, then switch N-TAN on.
- 7 Select Menu 1, then PAGE, to replay the drawing at the original size.
- 8 Select FIND, then choose a point to be the origin of the grid.
- 9 Press and release T to fix the origin at that point.

SECTION TWO

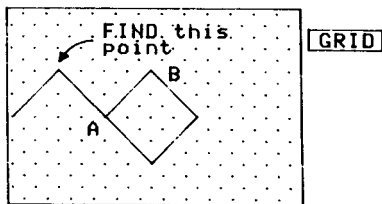

FIND a point to be the grid origin, then switch GRID on

Fig 3

- 10 Select Menu 2, then switch the GRID flag on. The 8 X 8 grid is now aligned with AB in Fig 3.
- 11 Switch N-TAN off to lock the cursor to the grid.

2.11.9 SETTING A SKEWED GRID WITH X AND Y

You've seen how to rotate an orthogonal grid to a chosen angle using the N-TAN lock. Now, using the other angle locks, you can skew the grid, i.e. set the X and Y axes to specific angles of your choice.

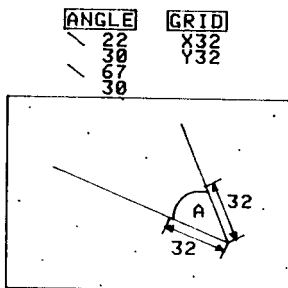

Fig 1

S E C T I O N T W O

- 1 **Clear the screen with WIPE.**
- 2 **Select Menu 2.**
- 3 **Set the X ANGLE vernier lock to 22 degrees, 30 minutes and then the Y angle to 67 degrees, 30 minutes. Then switch the vernier ANGLE flag on.**
- 4 **Switch the GRID flag on.**
- 5 **Switch the vernier ANGLE flag off.**
- 6 **Draw two lines as shown in Fig 1 (angle A is 45 degrees).**

Note: As before only those divisions along the axes you defined are equal to the indicated values, $X = 32$ and $Y = 32$.

SECTION TWO

2.12 TUTORIAL 12

Tutorial twelve continues with methods and techniques of using grids.

Isometric Grids

Preset Grids

Registration Marks using Preset Grid

Drawing Schematics using Preset Grid

Copying on to a Preset Grid

Zooming with a Preset Grid

Blending Arcs with a Locked Grid

2.12.1 ISOMETRIC GRIDS

You can generate perfect isometric drawings using a skewed grid set to $X = 30$ and $Y = 90$ degrees, at any spacing of your choice.

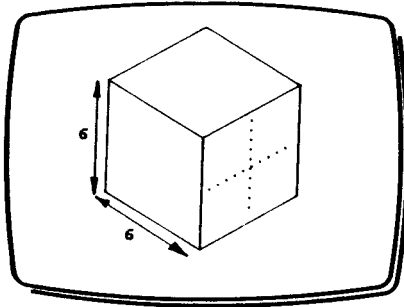

Fig 1

- 1 Clear the screen using WIPE.
- 2 Select Menu 2.
- 3 Leave the Y Coarse Angle on the default setting of 90 degrees. Set the X Coarse Angle to 30 degrees.
- 4 Set both X and Y grid spacings to 12.
- 5 Switch the ANGLE flag on.

SECTION TWO

- 6 Switch the **GRID** flag on.
- 7 Switch the **ANGLE** flag off.

You now have an isometric grid. Notice that true measurements can be made along both of the 30 degree axes and the vertical axis.

For practice with the isometric grid, try this drawing exercise.

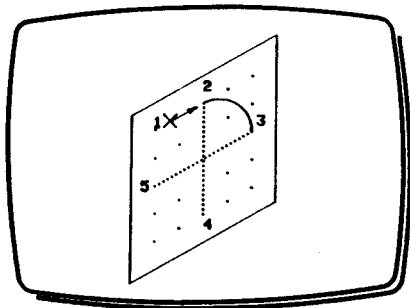

Fig 2

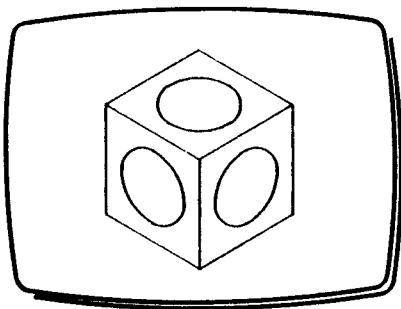

Fig 3

- 1 Draw the cube shown with 6 units per side as in Fig 1.
- 2 Select dotted line type 1 from the palette.
- 3 Draw a cross centred on the right face of the cube, the arms of the cross must all be equal. Use 2 or 4 units.
- 4 Select continuous line.
- 5 Move **XY** to position the dynamic cursor at (1) in Fig 2, then press and release **L** to plant the origin there.
- 6 Move **XY** to position the dynamic cursor at (2) in Fig 2, then press and release **L** to re-plant the origin. This sets the direction for the arc which follows.
- 7 Select **TAN ARC** from the palette.
- 8 Position the dynamic cursor at (3) in Fig 2. Then press and release **T** to draw the arc.
- 9 Repeat this at (4), (5) and (2) in Fig 2 to complete the ellipse.
- 10 Draw ellipses on the other visible faces of the cube, Fig 3.

SECTION TWO

- 11 Remove the dotted construction lines using ERASE, cancel the lock then select PAGE to replay the drawing.

The method described here draws an approximation of the ellipse, which you'll find adequate for all practical purpose. The system is also capable of generating mathematically perfect ellipses by 'squeezing circles'.

2.12.2 PRESET GRIDS

In addition to the grids with variable X and Y spacings, there are two preset 'convenience' grids on Menu 2 designated '8 X 8' and '8 X 6'.

Both of these grids automatically originate at the centre of the screen no matter where the origin cursor happens to be when the grid is selected.

This feature can be used to find the centre of the screen. It also provides a register grid which always appears in the same position on the Work Page.

The spacings of the two preset grids are chosen for two reasons, first, they are very convenient for general drawing assignments, and second, they divide exactly on to the dimensions of the Work Page. The preset grids are fixed at 0 and 90 degrees, and cannot be skewed or rotated.

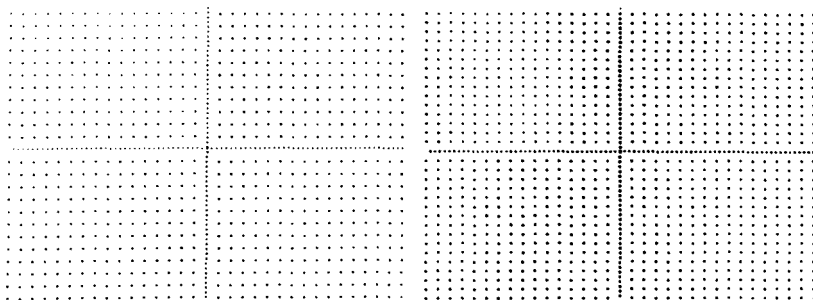

Preset 8X8 grid

Preset 8X6 grid

When either of the preset grids is displayed, the column of lock points on the extreme right is hidden by the menu, and the row along the bottom is hidden by the palette.

Although they are not displayed, these lock points are effective, and can be used in the normal way.

S E C T I O N T W O

2.12.3 REGISTRATION MARKS USING PRESET GRID

Preset grids are frequently used to generate registration lines and points for drawing symbols, or furniture units, etc., to a common datum position. A very useful registration point is the centre of the Work Page, which you can mark as follows.

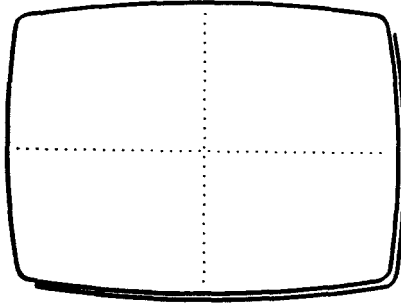

Fig 1

- 1 **Clear the screen using WIPE.**
- 2 **Select Menu 2.**
- 3 **Select 8 X 6, a grid with dotted cross-hairs will appear.**
- 4 **Select a dotted line type from the palette.**
- 5 **Position the dynamic cursor at top centre of the screen.**
- 6 **Press and release L to plant the origin cursor there.**
- 7 **Position the dynamic cursor at bottom centre of the screen.**
- 8 **Press and release T to draw a vertical line.**
- 9 **Repeat the above sequence to draw a horizontal centre line.**
- 10 **Reselect 8 X 6, then press and release L. The grid disappears, leaving the centre lines as you drew them.**
- 11 **For future use, FILE the centre lines in an empty library box.**

SECTION TWO

2.12.4 DRAWING SCHEMATICS USING PRESET GRID

Here we will use the 8 X 6 grid as a finder for the centre of the screen, then we set a larger grid at the same origin.

On the larger grid we will draw a figure which we will use as a dummy symbol to illustrate the principles of drawing schematics.

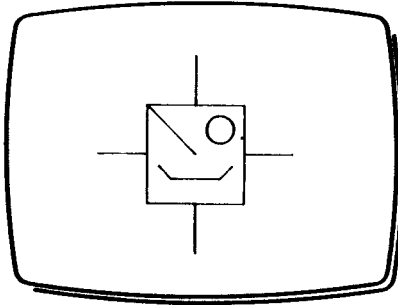

Fig 1

- 1 Clear the screen using WIPE.
- 2 Select Menu 2.
- 3 Select 8 X 6. A grid with crossed centre lines will appear.
- 4 Switch the GRID flag on. A 32 X 32 grid will now appear at the same centre origin.
- 5 Draw a square as shown in Fig 1, centred on the screen, 4 units each side.
- 6 Re-select 8 X 6.
- 7 Draw the 'dummy symbol' as shown in Fig 1.
- 8 Add vertical and horizontal 'connecting wires' from each side, extending to the limits of the grid.
- 9 Select Menu 1, then select FILE.
- 10 FILE the drawing in an empty library box.
- 11 Skip the label request.

SECTION TWO

You can assemble copies of the dummy symbol into a schematic on the 8 X 6 grid, using COPY and ZOOM functions, which act in a special way on this particular grid. To see just how easily a schematic can be assembled, try the next exercise.

2.12.5 COPYING ON TO A PRESET GRID

When using COPY on a preset grid, the scale of the copy cursor can only be altered in quantized steps. This ensures perfect registration and consistent size of symbols.

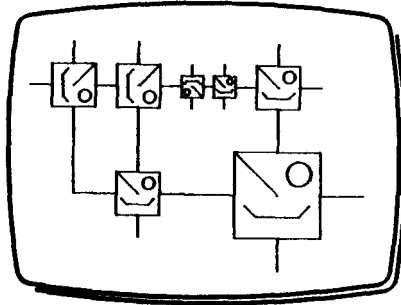

Fig 1

- 1 Clear the screen using WIPE.
- 2 Select Menu 2, then select 8 X 6.
- 3 Select Menu 1.
- 4 Select COPY, then acquire the shape you just filed.
- 5 When the Work Page returns, rotate Z to adjust the size of the cursor frame. You'll see that it jumps from one size to the next in fixed steps (watch the SCL value), instead of the usual smooth progression.
- 6 Now try to move XY to move the cursor frame about the Work Page, notice that the centre of the frame always homes on to a lock point.
- 7 Press and release T to plant different size copies of the symbol at various positions on the grid. Notice how the 'connecting wires' align easily.
- 8 Exit from COPY.

SECTION TWO

QUANTISED COPY RATIOS

You have seen how the COPY cursor frame has only a limited number of settings when a grid is in effect. These settings define the ratio of the library unit's original size, and its size as copied onto the screen. The four ratios available are 1:1, 1:2, 1:4, and 1:8.

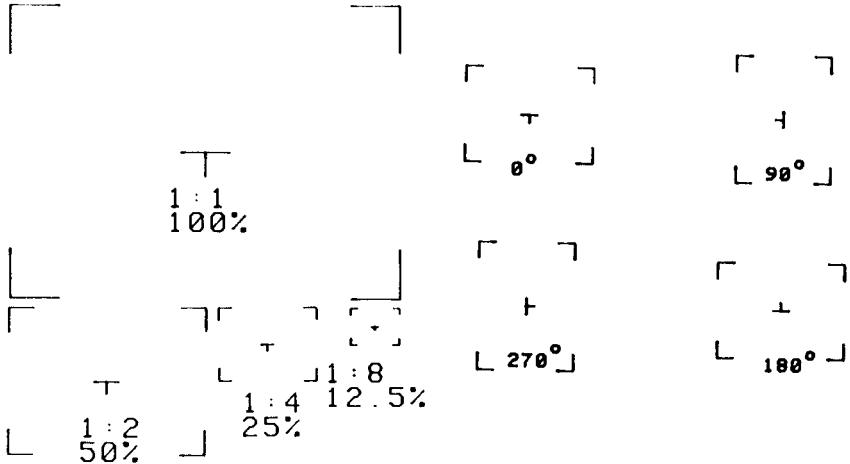

Four sizes

Four rotations

Here are the other COPY functions with the preset grid.

ROT The COPY cursor frame can be rotated through only four fixed settings when used with the preset grid 0, 90, 180 and 270 degrees. To rotate the cursor frame, press and hold L and rotate Z.

STR This is not available with the preset grid.

FLIP This operates in the usual way. To activate FLIP, press and hold R then select X or Y using the centre of the cursor frame.

2.12.6 ZOOMING WITH A PRESET GRID

As with COPY, the size of the ZOOM cursor (and therefore the magnifications available) is limited to four quantized settings, i.e. 1:1, 1:2, 1:4, and 1:8. You can, of course, zoom repeatedly for higher magnifications, 1:16, 1:32, etc.

This is helpful in two ways. First, it ensures perfect registration of the drawing on the grid, and second, it gives a 'nested' structure of locked grids within the preset grid on the base page, and so allows you to draw to precisely determined intermediate points.

SECTION TWO

You could try zooming on the schematic you drew in the previous exercise, but we suggest you do another drawing, this time using a dummy symbol with more than one connecting line on each side. This will show how useful it can be to ZOOM repeatedly to display successively finer grids.

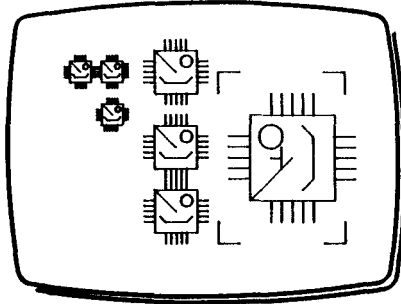

Fig 1

- 1 Clear the screen using WIPE and selecting the 8 X 6 grid, draw a symbol like the previous one but with 5 connecting lines at each side. Draw the lines to the edge of the grid, with 2 unit spacing between lines.
- 2 FILE the completed symbol and clear the screen with WIPE, then reselect the 8 X 6 grid.
- 3 Plant different sizes of the symbol at various position as shown in Fig 1 (those at top left are at 12.5%).

Now we'll ZOOM on the smaller symbols.

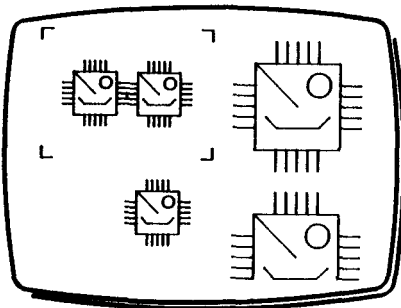

Fig 2

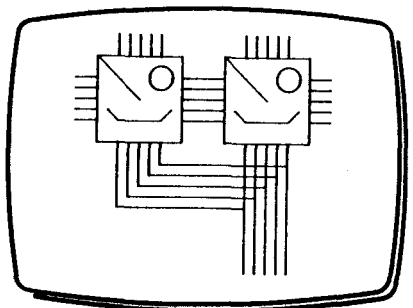

Fig 3

SECTION TWO

- 1 Press and hold R, then select ZOOM.
- 2 Rotate Z to adjust the zoom cursor frame. Just like the COPY cursor, it jumps from one size to the next (with a preset grid, the sizes available are the same for both ZOOM and COPY cursor frames).
- 3 Frame an area containing two or more of the smaller symbols, and press and release T to enlarge it (Fig 2).
- 4 Some of the connecting lines will be on lock points, some will not be, try ZOOM again to display a smaller scale with lock points on all the connecting lines. You may have to do this several times.
- 5 Exit ZOOM by pressing and releasing R and L together.
- 6 Using the grid lock points, make connections between symbols (Fig 3).
- 7 Press and hold R, then select PAGE to display the complete drawing, including the lines you just added.

2.12.7 TANGENT ARCS WITH A LOCKED GRID

A locked grid can be used to generate precise, repeatable arcs and fillets. Note that the following technique applies to any orthogonal axis (square) grid, either preset or variable.

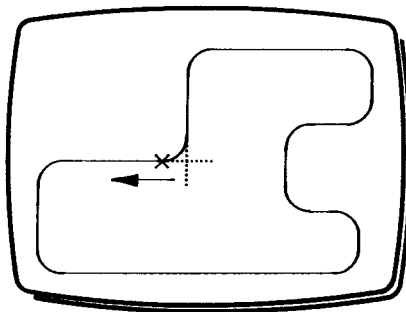

Fig 1

- 1 Clear the screen using WIPE.
- 2 Select Menu 2, then select 8 X 8.
- 3 Press and hold R, and select TAN ARC from the palette.

SECTION TWO

- 4 Move XY to position the dynamic cursor on the lock point, 1 unit to the left of the origin cursor.
- 5 Press and release L to re-position the origin cursor, so defining the arc's direction.
- 6 Move XY to position the dynamic cursor 5 units to the left. Notice that the 'arc' is a straight line, this is because the lock points are perfectly aligned.
- 7 Press and release T to draw the line.
- 8 Move XY to position the dynamic cursor 1 unit down and 1 unit to the left. This forms a perfect 90 degrees corner radius.
- 9 Press and release T to draw the arc.
- 10 Move the dynamic cursor down 5 units, and press and release T to draw another straight line.
- 11 Continue drawing arcs and lines to complete the shape as shown in Fig 1.

2.12.8 COMPASS ARCS WITH A LOCKED GRID

When a compass arc is used with a locked grid the 'free end' of the radius, which moves with XY, automatically attaches itself to the nearest lock point.

Once the radius of the arc has been set, move XY causes the radius marker to step round so that it is always aiming at the lock point nearest in line.

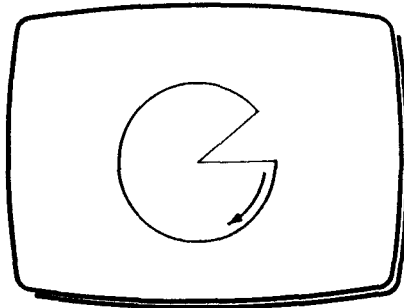

Fig 1

- 1 Clear the screen using WIPE.

S E C T I O N T W O

- 2 **Select Menu 2, then select 8 X 8.**
- 3 **Press and hold R, and select Compass Arc from the palette.**
- 4 **Move XY to position the radius 10 units to the right of centre, then press and release L to fix the radius.**
- 5 **Move XY to move the dynamic cursor clockwise through 315 degrees = $270 + 45$.**
At this point the radius lies along a diagonal row of dots, but the free end is not coincident with a lock point (the distance between points on the diagonal is approximately 1.4 units, which doesn't divide neatly into 10).
- 6 **Press and release T to draw the arc.**
- 7 **Select straight lines.**
- 8 **Draw a line back to the centre, and then to the start of the arc.**

2.13 TUTORIAL 13

This tutorial covers various additional information and techniques which were not included in the basic and precision tutorials.

How the screen images relate to physical drawings

The Library Disk system

Archive Disks

Buffer Disks

Drawing to points defined by intersections

Drawing radial lines

Symmetry in drawing

2.13.1 HOW SCREEN IMAGES RELATE TO PHYSICAL DRAWINGS

When you draw a line with the system, the start and end points of the line are remembered by the computer as co-ordinates, i.e. horizontal and vertical distance from the top left corner of the Work Page.

The Work Page is potentially of enormous size, and you can access any part of it using ZOOM. However, the screen view of the Work Page, no matter what the zoom level, is limited to a fixed number of points, or pixels. This is known as the resolution of the screen.

The screen image always appears at this resolution (which accounts for irregularities in the display), but the resolution of your drawing on the Work Page, as it resides in the computer's memory, is practically unlimited.

Although the screen view has limited resolution, ZOOM increases the co-ordinate resolution, allowing any level of detail to be added.

How much resolution do you need! The system allows you to draw with very high resolution, but experience will show you how far to ZOOM to produce drawings of the desired accuracy.

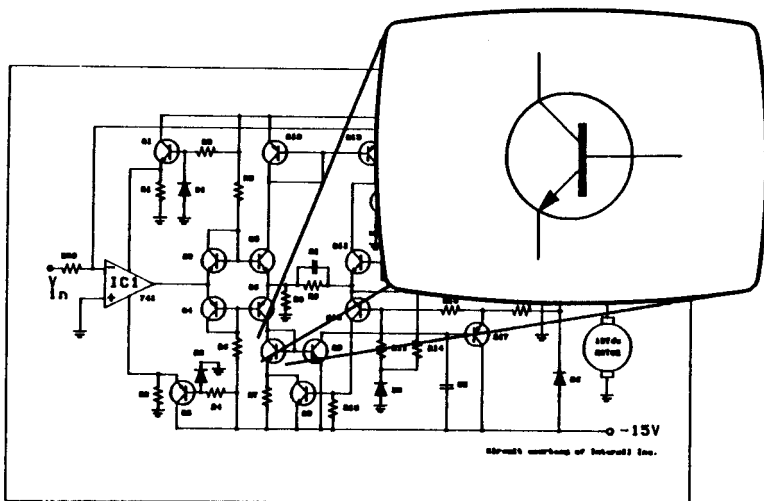

The screen is just a window on the Work Page!

2.13.2 THE LIBRARY DISK SYSTEM

How your drawing is stored

One of the system's most powerful features is its library system for data storage and retrieval.

The key to the library, both for you and the computer, is the Library Index. This gives the user a visual catalog of the library contents, and it also provides an elegant means for the computer to identify any element simply by its location on the page. Remember that to FILE a drawing on the disk, you need only point to the chosen index box then press a button.

The drawing you create on the screen is handled by the computer as a set of instructions based on coordinate points rather than as a shape, or mosaic of pixels. This set of instructions is used by the computer both to re-generate the drawing on the screen and also to effect COPY transformations such as position, scale, rotation, etc.

When you FILE a drawing, the set of instructions relating to that drawing is identified by the computer by its location code in the library, not by its visual appearance. This code is generated automatically by the computer when the library unit is filed.

SECTION TWO

This is not the same as the 'personal' label, such as a dimension or drawing number, which you may assign to a library unit via the keyboard. The personal label appears on the index page as a visual reminder only, and has no meaning to the computer.

The code contains three elements,

- 1 **Library volume number (1 through 254).**
- 2 **Index page identifier (A, B, or C).**
- 3 **Box location number (0 through 15).**

The coding system allows the computer to recognize over 12,000 unique library locations, provided each of the library disks is assigned a unique volume number.

CAPACITY OF THE LIBRARY DISK

In the system, drawings are stored in a highly compressed form. Exactly how many drawings you can store on a single disk depends on the complexity of the subject, i.e. the number of lines or functions used. Thus, a single library disk can store entries for approximately 12,000 straight lines of any length, or a smaller number of curve and text entries.

Although unlikely, this limit could be reached by only one or two drawings, if they contained an enormous number of detail entries. In this case the disk would be full but there would be many empty boxes on the index pages.

Typically, however, most of the index boxes will be used before the disk is filled if you use the disk in an appropriate way - large boxes for large drawings, small boxes for small drawings etc.

USING LIBRARY DISKS

As you use the the system, you will very quickly build up in Libraries a large number of drawings at various stages of completion, as well as other symbols, sketches, grids and blocks of text. An organized approach from the start will save you a lot a time, and also help avoid the grief of accidental erasure.

The library system can be used in the same way as the physical plan file found in conventional design office. But more than that, the library disk is a pictorial catalog (a bill of materials, if you like) of all the component parts or stages leading to a finished drawing. A library disk can in fact be the single source for all the information pertaining to a particular project.

S E C T I O N T W O

Although all library disks are organized in a similar way, they fall into three distinct categories,

- 1 **Library disks, volumes 1 through 220 (for your own source material).**
- 2 **Library disks, volumes 221 through 253 (reserved for pre-drawn source material).**
- 3 **Archive disks, volume 254 (a standard volume number for disks used to store finished work).**

FORMATTING YOUR OWN LIBRARY DISKS

'Format' means the arrangement of the empty index pages on the disk. Before a standard off-the-shelf 5 1/4 inch floppy disk can be used as a library disk, it must first be formatted, and this is provided for on the Systems Menu and covered in detail in Section 3 of this manual.

Before starting a proper drawing session, make sure you have enough formatted User library disks.

Choosing the number of index boxes

You should tailor the index pages to suit your application, i.e. large boxes 4 to the page, for large drawings; small boxes, 16 to the page for small symbols and letters. It's a good idea to have at least one 16 box page on each library disk.

CHOOSING THE VOLUME NUMBER

Your numbering system for Library disks is very personal! Here are some factors to consider,

- 1 The numbers available, i.e. recognized by the computer, for User Library disks range from 1 through 220.
- 2 There is no limit to the number of sets, each of 220 disks, so long as two volumes with the same number from different sets are not used in the one drawing session. (The computer cannot distinguish one set from another, i.e. it cannot differentiate between two library units coded Volume 5, Index A, Location 6.)
- 3 If there is no need to catalog, or structure the stored material, you can use any numbering system you like, provided you bear in the mind the above.

SECTION TWO

- 4 If you know in advance the extent of your pictorial data base, you can preallocate volume numbers for future work, e.g. Volumes 1 through 10 for electrical symbols, 11 through 20 subassemblies, 21 through 25 for standard text blocks, etc.

PRE DRAWN LIBRARY DISKS

Volume numbers 221 to 253 are reserved for pre-drawn Library Disks and therefore should not be used for the users own libraries.

2.13.3 ARCHIVE DISKS

FORMATTING YOUR OWN ARCHIVE LIBRARY DISKS

User library disks are intended both for active source material and finished work. The Archive disk is different, in that it is intended mainly as a store for a completed drawing, perhaps together with related amended versions, which you wish to preserve, but will not use as part of another drawing.

All archive disks have the same volume number 254, automatically assigned by the computer. Hence, you should not use more than one archive disk in a single drawing session.

Note: All indexes on the Archive Disk are limited to 4 boxes only.

USING THE ARCHIVE DISK

Drawings can be filed onto an archive disk in two ways.

- 1 Direct from the screen. When drawing is completed on the screen, replace the user library disk in the current Library drive with the archive disk. Then FILE the drawing in the normal way, and replace library disk.
- 2 From another library disk. If the completed drawing has already been filed on a user library disk, transfer it to screen using LOAD FROM LIBRARY on the UTILS menu, then proceed as above.

Note: For editing purposes, you can recover a drawing from the archive disk using LOAD FROM LIBRARY. Amend it, and then return it to the archive disk. You can either overwrite the old drawing, or place the amended version in a new box.

SECTION TWO

2.13.4 BUFFER DISKS

Buffer Disks are formatted by selecting the option from the System Menu and following the prompts given. As with any disk, it should be stored properly when not in actual use. Do not leave it in the drive for long periods when the system is not being used!

Note: You should replace the Buffer Disk periodically.

2.13.5 DRAWING TO POINTS DEFINED BY INTERSECTIONS

In traditional drafting practice intersections of lines are often used as datum points for the development of drawings. Similar techniques can be applied with this system.

The following exercise illustrates the basic idea using the standard geometrical construction for an equilateral triangle.

- 1 Clear the screen using WIPE.
- 2 Set a 32 x 32 grid by switching the GRID flag on.
- 3 Draw the baseline (AC), 5 units long as in Fig 1, (an odd number is used to show how the grid can be re-planted using FIND).
- 4 Select Compass Arc. Make the radius of the arc coincident with (AC) and press and release L. Then move XY to describe the arc (CQ), and press and release T to confirm (Fig 2).

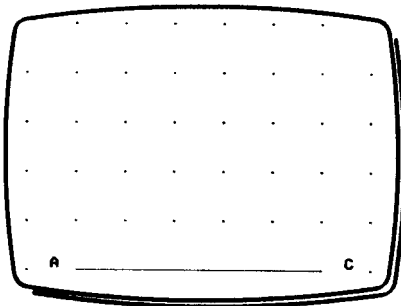

Fig 1

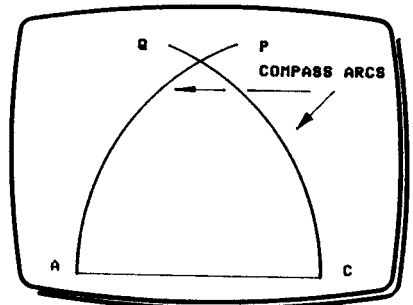

Fig 2

- 5 Select straight line, then place the origin at (A).
- 6 Select Compass Arc, then draw the arc (AP) in Fig 2.

SECTION TWO

- 7 Select straight line, then switch the GRID flag off.

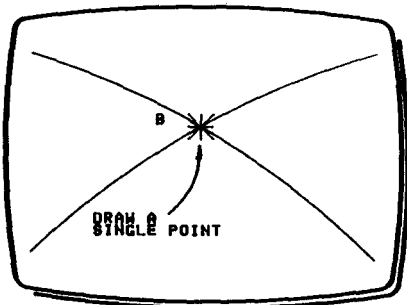

Fig 3

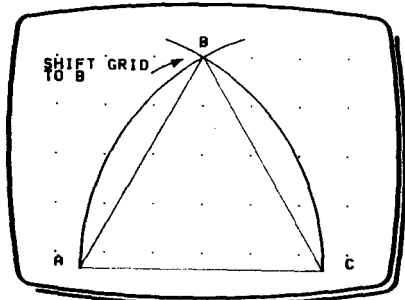

Fig 4

- 8 Select ZOOM, then enlarge the intersection of the two arcs as far as you can go in one step (this means shrinking the ZOOM cursor frame to about 1/4 inch wide on the screen).
- 9 Exit ZOOM, then position the dynamic cursor at the intersection of the arcs.
- 10 Press and release L to plant the origin cursor there. Then, without moving XY, press and release T to draw a single point at the intersection as in Fig 3 (you can't see it on the screen, but watch for the change in the memory count at bottom right).
- 11 Select PAGE to re-display the whole drawing.
- 12 Select FIND, find the single point you drew at the intersection, then press and release T to fix the origin cursor there.
- 13 Switch the GRID flag on, and it appears sourced to the new point.
- 14 Select FIND, and plant the origin cursor at (A) in Fig 4.
- 15 Position the dynamic cursor at the arc intersection (now a lock point), then draw line (AB) in Fig 4.
- 16 Select FIND, then repeat for line (BC).
- 17 Switch the GRID flag off.
- 18 ERASE the two arcs and the intersect point to eliminate them from the process.
- 19 Use PAGE to redraw the equilateral triangle without gaps.

SECTION TWO

2.13.6 DRAWING RADIAL LINES

Many two-dimensional drawings (wheel spokes, pipe flanges, etc.) are based on a structure of radial lines having a specific angle between them.

This example draws a construction outline with 7 equally spaced radials, which can be filed in the library, and then used as often as you wish. The angle between the radials is $360/7$ degrees, which approximates to 51 degrees, 26 minutes (See Fig 1).

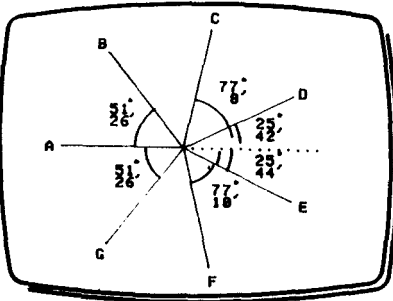

Fig 1

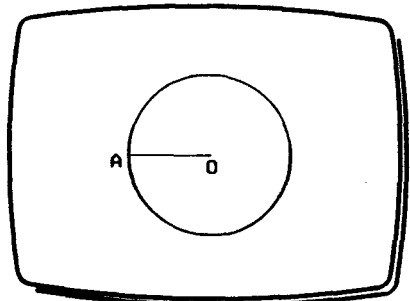

Fig 2

- 1 Clear the screen using WIPE.
- 2 Select the 8 x 8 grid (this is used to centre the construction).
- 3 Draw a circle of radius 10 units, centred on the grid (Fig 2).
- 4 Draw the radial (OA) in Fig 2.
- 5 Switch the GRID flag off.
- 6 Set the Y vernier angle to 51 degrees 26 minutes, then switch the ANGLE flag on.
- 7 Draw the radial (OB) as in Fig 3, then switch off ANGLE.
- 8 Select FIND, then locate the centre.
- 9 Set the Y vernier angle to 77 degrees, 8 minutes, then switch the ANGLE flag on.
- 10 Draw the radial (OC) as in Fig 4, then switch off ANGLE.

SECTION TWO

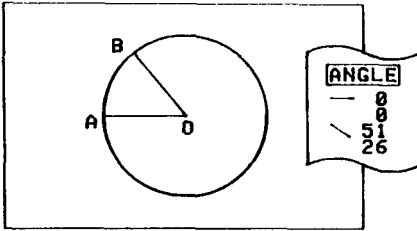

Fig 3

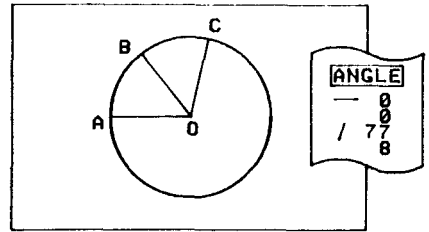

Fig 4

- 11 **Select FIND, then locate the centre.**
- 12 **Set the X vernier angle to 25 degrees 42 minutes, then switch the ANGLE flag on.**
- 13 **Draw the radial (OD) as in Fig 5, then switch off ANGLE.**
- 14 **Repeat for (OE), (OF) and (OG). Use X vernier for (OE), and Y vernier for (OF), (OG).**

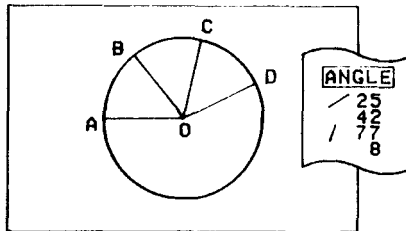

Fig 5

- 15 **ERASE the circle if you wish.**
- 16 **FILE the drawing in the library.**

The same basic technique can be used to produce radial constructions with any required angular spacing.

SECTION TWO

2.13.7 SYMMETRY IN DRAWING

Symmetrical structures can be drawn very quickly by reproducing a single cell in different orientations.

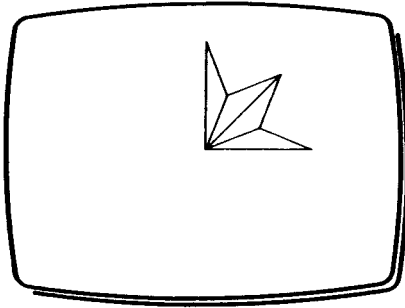

Fig 1

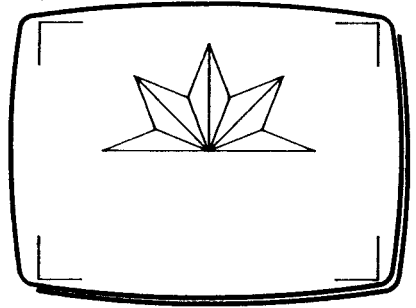

Fig 2

- 1 Clear the screen using WIPE.
- 2 Select the 8 x 8 grid.
- 3 Draw the shape shown in Fig 1.
- 4 FILE the shape in the library.
- 5 COPY the shape from the library.
- 6 Before planting the shape, press and hold R and select X FLIP.
- 7 Move XY to centre the cursor frame, then press and release T to fill the top left quadrant (Fig 2).
- 8 Press and hold R, then select Y FLIP (leave the X FLIP on).
- 9 Move XY to centre the cursor frame, then press and release T to fill the bottom left quadrant (Fig 3).
- 10 Press and hold R, then switch X FLIP off, leaving Y FLIP on.
- 11 Move XY to centre the cursor frame, then press and release T to complete the symmetrical figure (Fig 4).

SECTION TWO

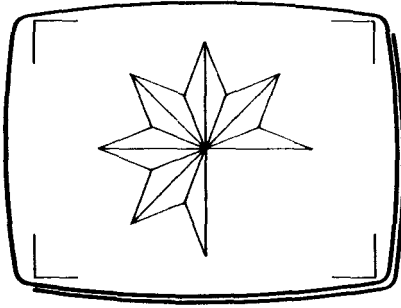

Fig 3

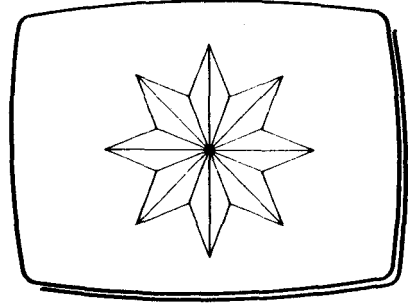

Fig 4

- 12 FILE the complete shape.
- 13 COPY the complete shape, then plant it centre screen at various scales (Fig 5).
- 14 Try painting the drawing, if you wish.

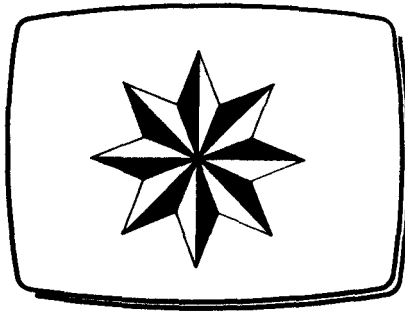

Fig 5

SECTION THREE

3.0 INTRODUCTION

Section 3 of the manual provides the means for users familiar with the system to refer to information directly by topic or function. It is assumed that readers of this section have completed the introductory tutorials.

Contents The reference section is organised into sub sections each covering a specific topic or function. Where a topic covers several functions of importance, they are indicated by subject within sub section.

Sub sections In general, each sub section is broken down into a brief function description followed by details of selection, operation and exit. These elements are repeated if there are several functions described.

Notes Additional or special points to note are indicated in the text by 'Note:'. 'Caution!' is used in the text to indicate a note of special importance.

Terms and Abbreviations Used A list of terms and abbreviations used in this section follow this introduction.

TERMS AND ABBREVIATIONS USED

Bitstik Controller

XY	Refers to left/right/up/down movement of the joystick control
Z	Refers to rotation of the knob in the centre of the joystick
T	Refers to the top button (coloured red)
L	Refers to the left button (coloured white)
R	Refers to the right button (also coloured white)
L and R	Refers to left and right button together
L and T	Refers to left and top button together

Origin Cursor Refers to the origin cursor, the 'x' shaped cursor

Dynamic Cursor Refers to the dynamic cursor, the '+' shaped cursor

SECTION THREE

3.1 SYSTEM MENU

This section describes how to start the system and prepare the disks required. If the system is being used for the first time, ensure copies of the SYSTEM MASTER disk supplied are made **BEFORE** continuing. Refer to the Disk System User Guide for details on making copies of disks.

Also, a number of LIBRARY and ARCHIVE disks should be formatted to retain any drawings created with the system. See Section 3.2 which describes their function and creation. Ensure a minimum of one Library and one Archive disk is prepared before running the Graphics Program itself.

To load the System proceed as follows:

- 1 **Insert the System Master Disk into Disk Drive 0 and close the flap. Hold down the SHIFT key, press and hold down the BREAK key; then release the BREAK key.**
- 2 **The disk drive will run for a few seconds with the 'in use' light illuminated. A title page will then be displayed, with the System Menu listing the available options.**
- 3 **Select the required option by entering the number indicated via the keyboard, and follow the prompts given. The options available are listed below.**

SYSTEM MENU OPTIONS The System Menu options are

- 1 Run the Main Graphics program (see below)
- 2 Format Library Disks (Sect 3.2.1)
- 3 Format Archive Disks (Sect 3.2.2)
- 4 Format Buffer Disks (Sect 3.2.3)
- 5 Change Palette (Sect 3.3)
- 6 Restore Palette (Sect 3.3)
- 7 Compact Library Disk (Sect 3.4)
- 8 Restore Library Disk (Sect 3.5)
- 9 Exit from the system to BASIC

RUN GRAPHICS PROGRAM

When the Graphics Program is selected, a message is displayed indicating the program is loading. When loaded, a prompt is given to insert a Library Disk in Drive 0 and the Buffer Disk in Drive 1. After loading the appropriate disks, press RETURN key to proceed.

SECTION THREE

3.2 PREPARING AND FORMATTING DATA DISKS

The SYSTEM MASTER DISK supplied with the system contains the programs which operate the system, and is not used to store any data created by the user.

The system uses three types of data disks which must be prepared according to their use, **before** storing data on them. They are Library and Archive disks, which are used to store complete or component drawings, and a Buffer disk which is used as temporary storage during the compilation of a drawing.

LIBRARY DISKS Up to 253 Library Disks can be allocated by the user, numbered from 1 to 253. Of these, 24 numbers (221-253) are reserved for pre-drawn libraries, and these numbers should not be used for the users own libraries. Each Library Disk has three pictorial indexes labelled A, B, and C. In each index entry, a scaled down image of the drawing stored is shown. To allow for the complexity of different stored drawings, the maximum number of entries in each index may be specified by the user, either 16 or 4.

ARCHIVE DISKS The Archive Disk is a special kind of Library Disk they can be used **only** for storage of completed drawings. This gives the user the ability to create a library of finished work without utilising normal library disks.

BUFFER DISKS A Buffer Disk is required for temporary storage whenever the graphics program is used. For system use only one is necessary, however each user may choose to have their own buffer disk if preferred.

Caution! Data disks must be 'formatted' before they can be used, as described below. It is advisable to make a supply of pre formatted data disks of different types in case a disk becomes full in the middle of a drawing session.

3.2.1 LIBRARY DISKS

To format a Library Disk, proceed as follows:

- 1 Select option 2 on the System Menu.
- 2 Insert a new disk in Drive 1, and close the flap.
- 3 Select the surface to be formatted, top surface (1) or bottom surface (3).
- 4 Enter the 3 digit Volume Number you wish to allocate to this Library Disk and press RETURN key.
- 5 Enter the format for Library Index A (16 or 4 slots).
- 6 Repeat for Library Indexes B and C and then press RETURN key.

SECTION THREE

- 7 If you want a complete format for a brand new disk, i.e. general track format plus Library disk format, press 'Y'. If the disk has already been used, press 'N' to format for Library use.
- 8 The disk drive runs while formatting takes place.
- 9 When complete, the System Menu is displayed and another Library Disk may be formatted if required.

Note: Remember to label the formatted Library Disk with the Volume Number allocated.

3.2.2 ARCHIVE DISKS

To format an Archive Disk, proceed as follows:

- 1 Select option 3 on the System Menu.
- 2 Insert a new disk in Drive 1, and close the flap.
- 3 Select the surface to format, top surface (1) or bottom surface (3), and press RETURN key.
- 4 If you want a complete format for a brand new disk, i.e. general track format plus Archive disk format, press 'Y'. If the disk has already been used, press 'N' to format for Archive use.
- 5 The disk drive runs while formatting takes place.
- 6 When complete, the System Menu is displayed and another Archive Disk may be formatted if required.

Note: The system allocates Volume Number 254 to all Archive Disks.

3.2.3 BUFFER DISKS

To format Buffer Disks proceed as follows:

- 1 Select option 4 on the System Menu.
- 2 Insert a new disk in Drive 1, and close the flap.
- 3 When ready, press RETURN key.
- 4 If you want a complete format for a brand new disk, i.e. general track format plus Buffer disk format, press 'Y'. If the disk has already been used, press 'N' to format for Buffer use.
- 5 The disk drive will run while formatting takes place.
- 6 When complete the System Menu is displayed.

SECTION THREE

3.3 CHANGE AND RESTORE PALETTE

The four default colour options are as follows:

BACKGROUND	BLACK
TEXT	WHITE
COLOUR 3	RED
COLOUR 4	YELLOW

You can alter the System Palette from the default selection above, to establish the Background and three Foreground colours, from a selection of 16.

These comprise 8 'pure' colours and a further 8 'flashing' colours, all available for colours 3 and 4. However, the Background and text colours must be chosen from one of the 8 'pure' colours.

CHANGE THE DEFAULT PALETTE

To change the default palette proceed as follows:

- 1 Select option 5 on the System Menu.
- 2 A screen is displayed listing the 16 colour options.
- 3 Enter a number (1-8) for the required Background colour.
- 4 Enter a number (1-8) for the required Text colour. This may not be the same as the Background colour chosen.
- 5 Enter two numbers (1-16) for colours 3 and 4. These may not be the same as the Background colour chosen.
- 6 When completed the System Menu is displayed.

Note: The System Master disk should not have a write protect tab on it when changing the Palette, as the new selection is written back to the disk. The new palette is retained until changed or restored to the original default values.

RESTORE THE DEFAULT PALETTE

To restore the default palette proceed as follows:

- 1 Select option 6 on the System Menu and the default values are restored.
- 2 The System Menu is redisplayed when restoration is complete.

3.4 COMPACT LIBRARY DISK

This option optimises the capacity of a used Library Disk by reorganising the data more efficiently. It should be used periodically, and particularly when a Library Disk has been used extensively.

To compact a Library Disk proceed as follows:

- 1 **Select Option 7 on the System Menu.**
- 2 **Insert the disk to be compacted in Drive 1, and close the flap.**
- 3 **Select the surface to be compacted, enter '1' for the top surface, '3' for the bottom surface.**
- 4 **When ready press RETURN key.**
- 5 **The System Menu is displayed when the reorganisation is completed.**

3.5 RECOVER LIBRARY DISK

This option should be used if the data organisation on a Library Disk has been disrupted; for example, by the accidental removal of the disk during a FILE process. The system will try to re-construct the data organisation by examining the data left on the disk.

The recovery operation may or may not be successful. It depends on the exact circumstances under which the data was affected.

To attempt recovery, proceed as follows:

- 1 **Select Option 8 on the System Menu.**
- 2 **Insert the disk to be recovered in Drive 1, and close the flap.**
- 3 **Select the surface to be recovered, enter '1' for the top surface, '3' for the bottom surface.**
- 4 **When ready press RETURN key.**
- 5 **The System Menu is displayed when recovery is completed.**

SECTION THREE

3.10 MAIN FUNCTIONS (Menu 1)

FUNCTION Menu 1 provides the main system functions. These are grouped according to their overall uses, as follows:

DRAW, PAINT, TRACE and TEXT are the origination functions.

FILE and COPY are the library access functions.

ERASE, FIND, MOVE, DUPL and EXCH are the editing and manipulation functions.

ZOOM, PAN and PAGE are the viewing functions.

UTILS generates its own menu of utility functions.

WIPE is a utility to clear the screen, and reset the system.

EXIT To access the Precision Controls (Menu 2) select **MENU**. Menu 2 provides additional manipulation of the primary functions.

3.11 DRAW

FUNCTION The **DRAW** function, which is used in conjunction with the Draw Palette, provides the basic drawing operations. Lines, points, arcs and circles can all be drawn in different colours and with different line types (continuous, dotted, etc). Nibs, of definable pen strokes, can also be used.

SELECTION The **DRAW** function is the 'default' state, That is, when the system is loaded and Menu 1 displayed, this function is automatically selected. Similarly, after exiting other functions, **DRAW** will again become active. Selection of different data and line types is by **XY** movement into the Drawing Palette.

3.11.1 LINES AND POINTS

FUNCTION Just as **DRAW** is the default function, so **LINES** is the default data type on the Draw Palette.

OPERATION To draw a line, first position the Dynamic Cursor at the desired point of origin using the **XY** Control. Then press **L**, which causes the Origin Cursor to jump to this selected position. Now move the Dynamic Cursor to the point at which the line is to end. Press **T** and the line will be plotted in the colour and line type specified on the Draw Palette.

S E C T I O N T H R E E

Note: The Origin Cursor automatically updates to the new position of the Dynamic Cursor. To continue drawing from a new point, move the Dynamic Cursor again, before updating the position of the Origin Cursor by pressing L.

To plot a single point, position the Dynamic Cursor at the required location, update the Origin Cursor by pressing L and plot the point by pressing T.

EXIT To select another data type move the Dynamic Cursor to the required option and the indicator will jump to that choice. Now move the cursor away vertically.

3.11.2 TANGENT ARCS

FUNCTION Arcs can be drawn in two different ways: either from a point on the circumference (Tangent Arc) or by defining the centre (Compass Arc). The tangent arc can be used for producing fillets.

SELECTION Select the Arc type from the palette.

OPERATION On selection, a 'rubber-banded' arc is displayed, blending from the previous end-point. You can set the arc by moving the XY Control to the required position. Press T to plot the arc.

If required, you can draw another arc by following the procedure above. If the arc is almost flat, it will default to a straight line. Similarly, if no direction has been given for this arc, a straight line will be drawn.

Note: An arc can be started in 'free space' (not connected to a previous data point) by updating the Origin Cursor twice along the required arc direction.

EXIT To exit, select another data type with the Dynamic Cursor.

3.11.3 COMPASS ARC

FUNCTION Arcs can be drawn in two different ways: either from a point on the circumference (Tangent Arc) or by defining the centre (Compass Arc). The Compass arc can be used like a 'digital compass'.

SELECTION Select the Arc type from the palette.

S E C T I O N T H R E E

OPERATION On selection, the Origin and Dynamic Cursors are replaced by a dotted radius line emanating from the Origin Cursor, with a dotted circle indicating the described arc.

The radius line can be rotated about the origin by circular movement of the XY Control to establish the start position, and the radius can also be adjusted by using the XY Control (to stretch the radius line). When the required radius and starting position for the arc has been set, press L to establish.

You can then move the XY Control to subtend an arc of the required angle. The direction of 'sense' of the arc can be changed by pressing L. When the required arc has been set, press T to draw it.

Note: If necessary, you can exit from the function by holding down R to redisplay the Dynamic Cursor and making a new palette selection.

Note: You can use the Angle Locks (Sect 3.31) to establish a precise start and end angle.

EXIT To exit, hold down R and select another data type with the Dynamic Cursor. Release R when the new selection has been made.

3.11.4 CIRCLES

FUNCTION Complete circles may be drawn in a single step with this facility, without using arcs.

SELECTION Select Circles from the Draw Palette.

OPERATION The Dynamic Cursor is replaced by the Circle Cursor. Its centre is moved using the XY Control while the diameter is varied by rotating the Z Control. To draw a circle, move the centre of the Circle Cursor to the required position, set the diameter and deposit the circle by pressing T. The drawn circle will not become visible until the Circle Cursor is moved away.

EXIT To exit, select another data type with the cursor.

SECTION THREE

3.11.5 NIBS

FUNCTION In this mode the normal Origin and Dynamic Cursors are replaced by two Nib Cursors. The Dynamic Nib Cursor is an extendable line. At the right hand end of the Dynamic cursor is a small diamond shaped marker, indicating the 'active' part of the cursor for menu and palette selection. Drawing between Origin and Dynamic cursors in this mode produces 'block' drawing between the two cursor positions.

SELECTION Select Nibs from the Draw Palette.

OPERATION The Dynamic Nib Cursor is a single line whose length is adjusted by rotating the Z Control. Cursor angle is adjusted by holding down R whilst rotating the Z control. Release R when the desired angle is reached.

The Nib Cursors work in a similar way to the Origin and Dynamic Cursors, the Origin Nib can be updated to the Dynamic Nib's position by pressing L. This now defines the start position, length and angle of the nib stroke. The Dynamic Nib is then moved to the required position (adjusting length and angle if desired). To fill in the area between the two cursors, press T. The nib stroke is drawn in the colour and line type selected on the palette.

By selecting different line types the spacing across the width of the stroke can be varied. The spacing along the length of stroke (Nib Type) can also be adjusted by moving the XY Control to the Nib Type Indicator on the palette, and holding down L. Rotate the Z control to adjust the block to the right of the indicator from solid (the default state) to a maximum spacing of 5 points. Release L to set the length spacing.

A variety of nib textures can be achieved using combinations of line and nib types, from a solid area of colour to a field of dots.

EXIT To exit Nibs select another data type with the 'active' cursor.

3.12 PAINT

FUNCTION The PAINT function enables you to colour-fill any completely enclosed area using the special 16-colour Paint Palette.

SELECTION Move the Dynamic Cursor to the PAINT legend on Menu 1 and press L. The legend illuminates when selected and the Paint Palette replaces the Draw Palette.

SECTION THREE

OPERATION Select the required colour from the palette with the Dynamic Cursor. Move the cursor into the area to be painted and press T. The enclosed area will be filled with the selected colour.

Caution!: An attempt to fill any area not fully enclosed will cause a leak of colour through the gap.

If black has been selected, the PAINT function will erase the entire shape, including anything connected to it by a line.

Note: In ZOOM, areas might be opened up causing leakage of colour to occur. Similarly, after using ERASE (Sect 3.17) or erasing a grid (Sect 3.32) gaps may be caused in existing entries; if this happens use PAGE to regenerate the drawing intact.

If you PAINT a shape under ZOOM, ensure that it is applied at the same ZOOM level. Otherwise it is possible that because the entries are not at the same level, the paint entry will overflow and fill the screen.

EXIT To exit the PAINT function, apply the Dynamic Cursor to the DRAW legend and press L. The PAINT legend will switch off and the Draw Palette will replace the Paint Palette.

3.13 TRACE

FUNCTION The TRACE function enables freehand drawing in 'stream' mode using the controller. In this mode a continuous freehand line is drawn following the movement of the XY Control.

SELECTION Move the Dynamic Cursor to the TRACE legend and press L. The legend illuminates when selected and the cursor changes to a small dot.

OPERATION To use this facility, move the Dynamic Cursor to the required start position. Hold down T. A continuous line will be generated as the XY Control is moved.

Note: Stream uses a lot of memory and should be employed sparingly. The system will beep when 1000 bytes of continuous stream has been entered, and will stop accepting input. To continue, release T and restart from the end point.

EXIT To exit, release T and reselect DRAW.

S E C T I O N T H R E E

3.14 TEXT

FUNCTION This function enables you to incorporate text during the compilation of a drawing.

SELECTION Move the Dynamic Cursor to the TEXT legend and press L. The legend illuminates when selected and the screen display changes to text mode.

OPERATION Enter the required text using the keyboard. To obtain upper case characters use CAPS LOCK or SHIFT keys. Remember to terminate each line of text with RETURN key. When you have entered the desired line or block of text, press L and R simultaneously. You will find that the Text Cursor is now displayed, configured to the text entered, at normal scale and un-rotated.

The scale of the text can be adjusted by rotating the Z control through the following range: x4, x2, x1, x1/2, x1/4. Rotation of the text can be adjusted by holding down L and rotating the Z Control through following steps: 0 deg, 90 deg, 180 deg, 270 deg.

When the position, scale and rotation have been set, press T to enter the text on the Work Page.

To exercise further manipulations over text and characters, any character or string can be entered via FILE as a Library Unit, which can be subsequently adjusted using Copy Palette functions.

Note: If text is subsequently viewed under ZOOM, any text greater than 8 times original scale will not be displayed. Similarly, any text will be displayed as dotted lines if it is too small to be legible.

Text responds to the colour specified on the palette, but the line type is fixed as solid.

When used on a grid or angle lock, the text cursor's 'lock point' is its left-hand corner.

If you attempt to plant text partially outside the Work Page, the system will beep and ignore the command.

EXIT Exit from TEXT occurs when the text has been deposited on the Work Page, or L and R are pressed.

SECTION THREE

3.15 FILE

FUNCTION The FILE function enables you to store the Work Page as a Library Unit on a Library or Archive Disk, for later use.

SELECTION Move the Dynamic Cursor to the FILE legend on Menu 1 and press L. The legend illuminates when selected.

OPERATION The Work Page is replaced by the current Library Index, and the Copy Cursor becomes active. If another index is required press R for the next index or L for the previous one.

The frame cursor can be moved around the Library Index to select a slot for filing the unit. Press T to deposit the unit, to store it for subsequent use. An existing Library Unit can be overwritten by a new unit if it is no longer required, and is then permanently erased from the Library Disk.

Having deposited the unit in the library, a prompt is presented allowing you to label the filed unit. The size of the label is dependent on the index format:

16 slot index - 10 characters can be entered

4 slot index - 20 characters can be entered

The label does not form part of the data, and is for reference use only. If you do not want to add a label, just press L and R simultaneously to exit.

Caution! If you want to FILE onto different Library or Archive Disks, simply change the disk (ensuring that you close the drive flap), before you select FILE.

You can produce Library Units with up to 16 levels of 'nesting' i.e., the inclusion of further Library Units, which include further Library Units and so on, up to 16 levels. You should therefore be careful not to overwrite a Library Unit that has been used elsewhere (for instance, in the compilation of another 'composite' unit).

EXIT The FILE function is exited after labelling, or if L and R are pressed.

3.16 COPY

FUNCTION COPY enables you to retrieve a previously stored Library Unit from a Library Disk to include in a drawing.

SELECTION Move the Dynamic Cursor to the COPY legend and press L. The legend illuminates when selected.

SECTION THREE

OPERATION The Work Page is replaced by the current Library Index and the Copy Cursor becomes active. If another Library Index is required, press R for the next or L for the previous one.

When an unit has been selected, the Copy Palette replaces the current palette. This presents the options available with COPY, MOVE and DUPL to set the parameters for:

SCALE, ROTATION and STRETCH
X-FLIP and Y-FLIP (the two mirroring functions)
Override of the stored colour and line type of the Library Unit to be deposited.

These options can be used in any combination.

The Copy Cursor can be moved around the Index to select the required Library Unit. Press T to pick up the unit. The index is automatically replaced by the Work Page and the Copy Palette selected. The unit can then be placed at any location on the Work Page using the XY Control and deposited by pressing T.

The Library Unit can be repeated in as many instances as wished, by pressing T when the position has been set.

The unit can be manipulated in SCALE, ROTATION and STRETCH prior to depositing. SCALE is adjusted by rotating the Z Control, ROTATION is adjusted by holding down L while rotating the Z Control, and STRETCH is adjusted by holding down R while rotating the Z Control.

Note: If you want to copy a Library Unit from another disk, change the Library Disk **before** you select COPY. However, you cannot copy from an Archive Disk.

For use of COPY with GRID and ANGLE LOCKS, see COPY AND ZOOM WITH LOCKS (Sect 3.33).

EXIT To exit the COPY function, press L and R after copying a unit, or when an index is being displayed.

3.16.1 SCALE, ROTATION and STRETCH

When using COPY you can lock the three Copy Cursor parameters.

Set the parameter using the Z Control (plus L for Rotation and R for Stretch), as previously described.

Select the parameter to be locked by moving the cursor to the SCL, ROT or STR legend (an arrowhead marker will indicate the locked option).

SECTION THREE

Any combination of parameter overrides is allowable.

SCALE is adjustable as a percentage of full size between 0.5 and 100 in increments of 0.5, with 100 representing full page scale.

ROTATION is adjustable from 0 to 355 in increments of 5 degrees, with a default of 0.

STRETCH is adjustable in the range 15 to 100 in increments of 0.5, with a default of 50. This represents a scale from full X-Stretch through normal to full Y-Stretch.

Having pre-set these values, they will continue to define the Copy Cursor until switched off or altered. To switch off, move the cursor to the legend, reselect and move away, and the marker will switch off.

3.16.2 X-FLIP and Y-FLIP

FUNCTION The X-Flip and Y-Flip options enables you to deposit the mirror-image of a Library Unit in the X and/or Y axes. The 'T' marker at the centre of the Copy Cursor indicates the two axes.

SELECTION Select X or Y-Flip from the Copy Palette by moving the cursor down to the required option until the arrowhead marker jumps to the legend.

OPERATION Move the cursor away vertically, ensuring that the indicator remains 'on'. You can then deposit the Library Unit as described above.

Note: You can set both X and Y-Flip. This is equivalent to a 180 deg rotation.

EXIT To switch off the Flip option, re-select the option with the cursor then move it away vertically, and the marker will switch off.

3.16.3 COLOUR and LINE TYPE

FUNCTION This option allows you to override the colour and/or line type settings of all the data in a Library Unit, prior to placing it on the Work Page.

SELECTION Move the cursor to the colour or line type blocks on the palette. An arrowhead marker will indicate the selection.

SECTION THREE

OPERATION Hold down L and rotate the Z Control to adjust the line type or colour. As the control is rotated, four line types or four colours are displayed in sequence. When the required selection is displayed, release L and move the cursor away vertically, ensuring that the indicator remains 'on'. You can then deposit the Library Unit as described above.

To switch off the override options, reselect with the cursor and move it away vertically, then the marker will switch off.

3.17 ERASE

FUNCTION The ERASE function enables you to erase the last entry made to a drawing or to step back through the previous sequence of entries to erase any particular entries that are not required.

SELECTION Move the Dynamic Cursor to the ERASE legend and press L. The legend illuminates when selected.

OPERATION The following cursors are used to denote the different entries:

LINES	Two Erase Cursors (diamond-shaped), for start and end points.
ARCS	Three Erase Cursors, for centre, start and end points.
CIRCLES	Three Erase Cursors, for centre and two points on the circumference.
NIBS	Four Erase Cursors at the corners of the nib stroke.
PAINT	Single Erase Cursor at original colour fill point.
TEXT	Four Erase Cursors at the corners of the text block.
COPY	Copy Cursor framing the Library Unit.

To erase the last entry, press T. The entry will be **permanently erased** from memory.

If the last entry was a PAINT, the colour area will be erased from memory, **but will remain on the screen** until the Work Page is redrawn with PAGE or ZOOM.

S E C T I O N T H R E E

To erase earlier entries you can step back through the sequence until the required entry is reached. To step back, hold down L and the Erase Cursors will successively define each preceding entry. Release L to freeze the cursors and the entry is erased by pressing T. Similarly, to step forward, hold down R, releasing when the required entry is indicated and again erase by pressing T. The step back or forward will speed up the longer L or R is held down.

CONTINUOUS ERASE

Continuous ERASE can be achieved by holding down both L and T for a 'reverse erase', or with R and T for a 'forward erase'. When you reach the start of the sequence, you will 'wrap around' to the end of the sequence, and vice versa.

Note: If all entries have been erased in this manner, the ERASE function will be automatically exited.

When using ZOOM (Sect 3.22), the erase points for an entry may not be on screen and therefore the cursors will not be displayed. In this case use PAN (Sect 3.23) to move the view across to include the points, or apply an 'inverse zoom'.

You should be aware that the ERASE function paints out the entries with black. When this causes an underlying entry to be partially erased, the drawing can be restored with PAGE, ZOOM or PAN.

As Library Units are treated by the system as a single module, ERASE only erases the whole module. To erase part of a Library Unit, use LOAD FROM LIBRARY on the UTILS menu (Sect 3.25), to regenerate the Library Unit as a Work Page. ERASE can then be used to delete entries within the Library Unit. Then re-file the edited Library Unit and later use EXCH to exchange the amended version for the original.

LOAD FROM WORK PAGE (Sect 3.25) provides a similar facility for Library Units used as components or sub-assemblies within composite drawings. However, the two LOAD routines WIPE the Work Page, so ensure that the Work Page is filed first to preserve it in its original form.

EXIT Exit ERASE by pressing both L and R simultaneously. The ERASE legend will switch off and the Erase Cursors will be replaced by the Origin Cursor at the last selected entry.

3.18 **FIND**

FUNCTION The FIND function enables you to determine the precise co-ordinates of the end points of entries. It can be used to make a precise new entry at a chosen point, or to set up an ARC or GRID.

SECTION THREE

SELECTION Move the Dynamic Cursor to the FIND legend and press L. The legend illuminates when selected.

OPERATION The Origin and Dynamic Cursors are replaced by the Find Cursor, which sequentially indicates the start or end point of lines; the start, end and centre of arcs, the centre and circumference of circles, and the four corners of nib and text entries.

The FIND function operates in a similar way to ERASE. You can step back through entries by holding down L or step forward by holding down R. Release when the required location is reached. As with ERASE, when you step back or forward to the start or end of the sequence, you will 'wrap around'.

If you want to FIND more than one point, use a GRID (Sect 3.32) to establish a point array sourced from the Origin Cursor. You can then use FIND to obtain the other end point and can plot back to the grid-locked point.

EXIT To exit FIND, press L and R simultaneously. The Origin Cursor will then be established at the 'found' point.

3.19 MOVE

FUNCTION The MOVE function enables you to move Library Units which have been previously deposited on the Work Page with the COPY function.

SELECTION Move the Dynamic Cursor to the MOVE legend and press L. The legend illuminates when selected.

OPERATION The Dynamic Cursor is replaced by the Copy Cursor, which frames the last Library Unit placed on the Work Page, and the Copy Palette replaces the current palette; providing controls for placing the Library Unit.

Step backwards or forwards through the sequence of previously deposited Library Units using L and R, as described for ERASE. To move the framed Library Unit, press T. The Copy Cursor enclosing the selected Library Unit will freeze and a new active cursor is displayed. Move the cursor to the new position, altering Scale, Rotation and Stretch, if required. You can lock parameters on the Copy Palette as described under COPY.

To deposit the Library Unit, press T. The entry will be erased from its current position and regenerated at the new position. If it is not correctly positioned, you can move again.

EXIT Exit MOVE by pressing L and R simultaneously.

S E C T I O N T H R E E

3.20 DUPL (DUPLICATE)

FUNCTION The DUPL function enables you to pick up a previously deposited Library Unit directly from the Work Page and to deposit further copies on the same page.

SELECTION Move the Dynamic Cursor to the DUPL legend and press L. The legend illuminates when selected.

OPERATION The Dynamic Cursor is replaced by the Copy Cursor, which will frame the last Library Unit deposited on the Work Page. The Copy Palette replaces the current palette. To select an earlier Library Unit you can step backwards or forwards through the sequence of previously deposited units using L and R. To duplicate the framed Library Unit, press T. The Copy Cursor enclosing the selected unit will freeze and a new active cursor is displayed.

Note: You can also use the Copy Palette options when using DUPL. These options enable you to set and lock Scale, Rotation, Stretch X- and Y-Flip and Colour and Line Type overrides.

EXIT Exit the DUPL function by pressing both L and R simultaneously.

3.21 EXCH (EXCHANGE)

FUNCTION The EXCH function enables you to identify a previously deposited Library Unit on the Work Page and to replace it with another unit from the library at the same Scale, Rotation and Stretch. They cannot be altered during the EXCH operation.

SELECTION Move the Dynamic Cursor to the EXCH legend and press L. The legend illuminates when selected.

OPERATION On selection, the current Library Index is presented. Choose the Library Unit you want to substitute for the Library Unit (or Units) on the Work Page. Press T to select. The Work Page is then displayed with the Copy Cursor framing the last deposited Library Unit.

To identify an earlier Library Unit you can step backwards or forwards through the sequence of previously deposited units using L and R, as described for ERASE. When you have identified the Library Unit you want to replace, press T. The unit will be erased and replaced by the new Library Unit. If required, you can continue to step backwards or forwards to select another Library Unit for replacement.

SECTION THREE

EXIT Exit the EXCH function by pressing both L and R simultaneously.

3.22 ZOOM

FUNCTION The ZOOM function enables you to select an area on the Work Page and either expand it to full screen size or to contract the full screen into a defined area ('inverse zoom').

SELECTION Move the Dynamic Cursor to the ZOOM legend and press L. The legend illuminates when selected. The Origin and Dynamic Cursors are replaced by the Zoom Cursors.

OPERATION Move the Zoom Cursor to the area of the Work Page to be expanded. Set the zoom 'window' by rotating the Z Control. Press T and the area defined by the Zoom Cursor will be enlarged. If you rotate the Z Control further, the corners of the cursor will invert, indicating an inverse zoom. When positioned over the selected area and T pressed, the current view will be redisplayed in the framed area.

The display can be terminated at any stage by pressing the keyboard space bar.

Note: You can successively apply the ZOOM function to the Work Page without any degradation of the picture structure. However, once you reach the extent of data resolution, you cannot apply any further zooms. Similarly, you cannot apply an 'inverse zoom' beyond full base page, if you attempt this there will be an audible warning.

If used with a GRID (Sect 3.32) with a default 8X6 or 8X8 spacing, the Zoom Cursor will be quantised in scale (in x2 increments). On all grids, the origin of the Zoom Cursor is locked to the grid.

EXIT Exit the ZOOM function by pressing L and R simultaneously.

3.23 PAN

FUNCTION The PAN function enables you to move horizontally, vertically, or diagonally from a view generated by the ZOOM function.

SELECTION Move the Dynamic Cursor to the PAN legend and press L. The legend illuminates when selected.

S E C T I O N T H R E E

OPERATION The Origin and Dynamic Cursors are replaced by the Zoom Cursor, which is fixed at full-page size.

Move the cursor horizontally or vertically to include the off-screen area you wish to be displayed. When set, press T to display the defined area. As with ZOOM, you can terminate the display at any stage by pressing the keyboard space bar.

Note: PAN can only be used on a zoomed view and not from the base page. An audible warning will be given if this is attempted.

For further control, PAN can be employed in conjunction with a Grid Lock (Sect 3.32).

EXIT Exit the PAN function by pressing L and R simultaneously.

3.24 PAGE

FUNCTION The PAGE function redraws the Work Page. It is used after changes, erasures or for redrawing after using ZOOM.

SELECTION Move the Dynamic Cursor to the PAGE legend and press L. The legend illuminates when selected.

OPERATION On selection, the Work Page is redrawn at its original scale (base page).

EXIT Exit PAGE is automatic when the Work Page has been regenerated. Alternatively, PAGE can be terminated at any stage by pressing the keyboard space bar.

3.25 UTILS (UTILITIES)

FUNCTION This option provides several additional utility functions as follows:

Load enables you to retrieve or isolate Library Units to perform further drawing or editing.

Zoom Store provides temporary storage of zoom views.

Screen Images provides facilities for the storage, retrieval and printing of screen display images.

Select Drive allows you to change the logical disk drive for the Library Disk.

Exit enables you to return to the System Menu, which also resets the system.

SECTION THREE

SELECTION On selection, the Utilities Menu is displayed. Move the Menu selection bar up and down using the XY Control. Park the bar over the option required and press L to make the selection. To return to Menu 1, press both L and R simultaneously.

Each of these five utilities is described in detail in the following pages.

3.25.1 LOAD

The two LOAD options, LOAD FROM LIBRARY and LOAD FROM WORK PAGE, allow you to treat Library Units as collections of individual entries (as they were first compiled), rather than as a single module, (for which the COPY function is used).

Once loaded, therefore, the system reverts to the DRAW function and you can then continue working on the unit as a normal drawing (including erasing parts of the drawing).

Caution! These functions WIPE the Work Page before accessing the Library Index. Be sure to FILE the Work Page first if you want to save it.

LOAD FROM LIBRARY

This function enables you to load a Library Unit from a Library Index for editing or amendment.

Note: If you have 'backed up' a drawing you are working on, use this function to retrieve the drawing for continued work.

On selection, the current Library Index is displayed and the required Library Unit selected using the Copy Cursor. Press T to load the unit. Step back or forward using L or R to display the other Library Indexes.

The selected unit is brought from the Library and deposited automatically on the new Work Page at full screen resolution. You can then amend the unit as required, saving the new version with the FILE function.

LOAD FROM WORK PAGE

This function enables you to isolate and load a Library Unit from the Work Page, for editing or amendment.

On selection, the Work Page is redisplayed with the Copy Cursor framing the last Library Unit deposited. You can step back through the sequence of entries by pressing L or step forward by pressing R.

S E C T I O N T H R E E

When the required unit has been identified, press T. The Work Page is then erased (via WIPE) and replaced by the selected unit. You can then amend the Library Unit as required, saving the new version on the Library Index via FILE. Use SWAP to replace the new version for the old.

If the selected Library Unit contains lower levels of 'nested' Library Units you can repeat the above process to identify and extract a lower level unit for editing.

For a fuller review of composite Library Unit editing, see Editing (Sect 3.43).

3.25.2 ZOOM STORES

This function enables you to temporarily save, and subsequently view two Zoom Views. It provides an alternative to the PAGE function by redrawing the Work Page at the stored Zoom View, rather than at the base view:

You can select SAVE or LOAD using the STORE 1 or STORE 2 mode.

When SAVE is used, the current Zoom View is stored in the designated store and will be available for subsequent viewing with the LOAD option. When LOAD is used, the Work Page is temporarily replaced by the Zoom View from the selected store.

Note: Changes made to the Work Page are automatically incorporated into any stored zoom views affected by the changes.

3.25.3 SCREEN IMAGES

These utility options deal with the display, storage, and retrieval of screen images i.e. the screen display at one moment during the drawing process.

FULLSIZE

This function enables you to view the Work Page without the Menu palette overlays. On selection, both the Menu and palette are erased and the Work Page expanded to full screen size.

To store the Screen Image, you can directly enter the SAVE function by pressing T (see below).

EXIT Exit the function by pressing L and R simultaneously. Menu 1 and the Draw Palette will be redisplayed and the Work Page regenerated at base scale.

SECTION THREE

SAVE

This function enables you to store a Screen Image on a normal formatted disk for future use.

On selection of the option you are requested to enter a name (maximum 7 characters) for the image for subsequent reference, e.g. PICTURE, followed by RETURN key.

The advantage of using SAVE IMAGE is that more complex screen drawings can be generated than the available user memory can accommodate, plus the reloading of the image may be faster than the replay of a complex page. Thus, a complex background for a drawing sequence can be created, saved as an image, and then loaded very quickly when required.

Caution! Since the SAVE IMAGE function simply stores the entire screen contents rather than the drawing structure, it uses a great deal of storage space and should therefore be used with care.

Note: Unwanted images can be deleted from the disk using the CATALOG function.

Images can also be used as tracing overlays, since they do not form part of the Work Page data.

LOAD

LOAD enables you to retrieve a Screen Image from the disk for viewing and output using PRINT if desired.

On selection, you are requested to enter the name of the required image (previously reviewing the image names via CATALOG if necessary). Press RETURN key and the selected image will be displayed on the Work Page.

PRINT

PRINT enables you to output the screen image to a compatible matrix printer. Use LOAD to bring in the required image.

On selection, the screen is cleared and the image is printed.

CATALOG

CATALOG enables you to review the list of images stored on a disk and, if wished, delete any images on the disk.

On selection, the Image Catalog is displayed. To delete an image, press T and enter the name of the image to be deleted.

When deletion is completed, the utilities menu is re-displayed.

S E C T I O N T H R E E

3.25.4 SELECT DRIVE

Select Drive allows you to assign another logical drive for the Library i.e. the drive the system will use for COPY, FILE or image storage.

The logical drives are designated as follows:

PHYSICAL DRIVE	LOGICAL DRIVE
0	Top = 0 (Default Library) Bottom = 2 (Secondary Library)
1	Top = 1 (Buffer) Bottom = 3 (Unused)

From the table above, it is apparent that both sides of the Library disk can be formatted as separate Library drives. Thus, this gives two Library drives that can be available for library storage without changing disks.

When selected, the current Library Drive is displayed.

Press L to change the Drive, and the system will check that the selected drive has been formatted correctly, and then display the new drive.

3.25.5 EXIT

The EXIT function allows you to exit the Main Graphics program and return to the Systems Menu. On selection, follow the disk change prompt given and reload the System Master disk.

3.26 WIPE

FUNCTION The WIPE function clears the Work Page and 'resets' the system.

SELECTION Move the Dynamic Cursor to the WIPE legend on Menu 1 and press L and T.

OPERATION WIPE clears the memory of the sequence of entries added since starting and resets the memory counter.

Caution!: This command also resets the system default conditions and clears all buffer areas, including the buffer disk.

EXIT Exit from WIPE is automatic.

S E C T I O N T H R E E

3.30 PRECISION CONTROLS (Menu 2)

FUNCTION Menu 2 presents the Precision Control functions. They are the Angle and Grid Locks which can act like a set square, ruler, or variable graph paper to aid in the composition of a drawing.

- When an Angle Lock is set, the cursors can only move along the defined angle path.
- When a Grid Lock is set, cursor movement is restricted to the defined grid points.

Angle Locks and Grid Locks can be used separately or in combination.

EXIT To access the Main Functions (Menu 1) select MENU.

3.31 ANGLE LOCKS

FUNCTION The top sequence of functions on Menu 2 present the Angle Lock controls. They are grouped into four blocks.

Block 1 enables the two Angle Locks (X and Y) to be set in degrees and minutes.

Block 2 enables two Angle Locks (X and Y) in degrees only.

Block 3 is a default Orthogonal Lock (0-90 Deg).

Block 4 is a default Normal Tangent Lock (0-90 Deg) relative to a line or arc.

Two definable Angle Lock pairs are provided to enable switching conveniently from one to another, e.g. from an isometric lock to another non orthogonal lock and back to the isometric.

The lock will move to the Origin Cursor position as it is updated via T or L.

Note: LOCK OVERRIDE Once an Angle Lock is set, the cursor is locked onto that angle path. Thus the menu is not accessible to switch off the lock or make another selection. To free this restriction when a lock is set, hold down R. The lock will move to the Origin Cursor.

3.31.1 ASSIGNABLE ANGLE LOCKS

OPERATION First position the Origin Cursor at the location from which the Angle Lock should emanate. Move the Dynamic Cursor to either the X or Y angle markers. The marker will flash when selected.

S E C T I O N T H R E E

Hold down L and the marker will stop flashing. Adjust the value by rotating the Z Control. When the required angle is set, release L to establish the setting.

The X angle can be adjusted in the range 45-0-45 degrees, and the Y angle in the range 45-90-45 degrees.

If further accuracy is required, the minutes indicator beneath the appropriate angle indicator may also be set. Follow the procedure given above for setting degrees. Minutes can be adjusted in the range 0-59 minutes.

Having set the angle, move the Dynamic Cursor to the ANGLE legend. The legend will flash when selected. Press L and withdraw the cursor. The legend will stop flashing, but remains illuminated while the lock is on. The cursor is now restricted in its movement to the specified angles. Override the lock by holding down R.

To switch off the lock, release the cursor by holding down R and moving the cursor to ANGLE. When the legend flashes, press L and move the cursor.

3.31.2 SECOND ANGLE LOCK

Since there are two blocks of programmable Angle Locks, you can set up a second pair to be used in conjunction with the main Angle Locks.

Note: The second block can only be set in degrees.

The procedure for setting the lock is precisely as described above for the main Angle Locks.

Only one pair of Angle Locks can be on at one time. When a second lock is selected, the first will automatically switch off.

3.31.3 DEFAULT ANGLE LOCKS

OPERATION There are two default Angle locks, ORTHO (Orthogonal) and a N-TAN (Normal-Tangent).

To select either default, move the cursor to the legend, press L and move the cursor away.

To de-select, follow the same procedure (under R button override procedure).

ORTHO is a default 0-90 deg Angle Lock, which is the default value for both the programmable values.

N-TAN generates a lock tangential to the previous vector entered (i.e. line or arc), plus the normal to the tangent (i.e. 90 deg).

S E C T I O N T H R E E

3.31.4 COPY WITH ANGLE LOCKS

For the use of COPY with Angle Locks, see COPY AND ZOOM WITH LOCKS (Sect 3.33).

3.32 GRID LOCKS

FUNCTION The middle group of functions on Menu 2 present the Grid Lock Controls. The first block enables the user to define a grid, with both the X and Y (horizontal and vertical) spacings individually adjustable between 4 and 32 screen points ('pixels'). Angle Lock can be used to determine the orientation of the grid.

Beneath the programmable grid block are two default grid settings which generate an 8 X 8 and an 8 X 6 grid, respectively. These default grids have been provided since they are frequently used. The 8 X 6 grid is in the same proportion as the Work Page and Library Index slots, for convenient use of the COPY function.

LOCK OVERRIDE As with the Angle Locks, use R to free a Grid Lock to make new selections, or to switch off the lock.

3.32.1 ASSIGNABLE GRID LOCKS

OPERATION First position the Origin Cursor at the position from which the grid should be sourced. The default grids are both automatically sourced from the Work Page centre.

Move the Dynamic Cursor to the X or Y spacing indicator. The indicator will flash when selected. Hold down the L and the indicator will stop flashing. Adjust the value by rotating the Z Control. When the required grid spacing is set, release L. Adjust the second grid axis by the same procedure, if required.

Having set the grid spacing, move the Dynamic Cursor to the GRID legend. The legend will flash when selected. Press L and withdraw the cursor. The legend will stop flashing, but will remain illuminated while the lock is on. The grid will be generated and the cursor becomes restricted in its movement to the defined grid locations.

The lock can be overridden at any time by holding down R. When R is released, the cursor will lock onto the nearest grid point.

Note: Re-source the grid from a new origin by switching off Grid Lock, re-positioning the Origin Cursor, and switching the lock back on again.

EXIT To switch off the Grid Lock and erase the grid, move the Dynamic Cursor (under R button override) to the GRID legend and press L. When the cursor is withdrawn the grid will be erased and the cursor freed.

SECTION THREE

3.32.2 NON-ORTHOGONAL GRIDS

The above procedures all relate to orthogonal (0-90 deg) grids. In many instances, however, you may wish to work with non-orthogonal grids (e.g. isometric).

This can be achieved by following this procedure:

- Set the required Angle Lock values, and switch on ANGLE to establish the lock.
- Under R button override, set the required grid spacings and switch on GRID to establish the Grid Lock.
- Again under R button override, switch off ANGLE to free the Angle Lock. Angle Locks always take precedence over grids.

Note: You may find it more convenient to set the required grid spacing, without switching on GRID, before you set the Angle Lock. This will avoid the necessity for setting grid spacings under R button override.

3.32.3 DEFAULT GRID LOCKS

OPERATION There are two default Grid Locks, 8 X 8 and 8 X 6. To select either default, move the cursor to the legend, press L and move the cursor away. To switch off, follow the same procedure (under R button override).

8 X 8 generates an 8 X 8 Grid with cross-hairs indicating screen centre, sourced from the Work Page centre.

8 X 6 generates an 8 X 6 Grid with cross-hairs indicating screen centre, sourced from the Work Page centre.

Note: These grids are particularly useful for producing schematic diagrams. The 8 X 6 grids enables production of schematic symbols at full Work Page size. When retrieved from the library, these symbols can be deposited on a default grid and simply connected to the other symbols.

3.33 COPY AND ZOOM WITH LOCKS

The origin of the Copy and Zoom Cursors is always locked to grid points. Further, the scale of the Zoom Cursors is locked when using the default grids. This enables zooming up on a fixed proportion of the Work Page. The process can be repeated as many times as necessary to construct complex symbol based drawings at high resolution. The scale of the Copy Cursor is similarly locked when using a default grid.

S E C T I O N T H R E E

3.33.1 ORTHOGONAL GRIDS

When used with COPY the Copy Cursor will be locked to the grid settings. Rotation is enabled in 90 deg steps. Scale can be adjusted in fixed grid increments (i.e. the Copy Cursor enclosing 2 x 2, 4 x 4, etc, grid blocks).

The Copy Cursor and Zoom Cursor are only restricted in scale settings when using the default grid spacings (8 X 6 and 8 X 8).

3.33.2 NON-ORTHOGONAL GRIDS

A non-orthogonal grid can be used to provide high resolution angular displacement when using COPY.

Before de-selecting the Angle Lock (after having set up the non-orthogonal grid), hold down L and rotate the Z Control to step through the four possible high-resolution angle settings.

Having selected the required setting, switch off the Angle Lock using the R button override. The Copy Cursor will be set to the assigned angle. Then fix the Copy Cursor origin to the required grid point (which is generally the grid source point).

S E C T I O N T H R E E

3.40 SYSTEM INFORMATION

This section briefly presents some aspects of the internal design of the system to enable you to make the best use of the facilities provided.

The following topics are covered

- Data Clipping
- File Structure
- Editing
- Record Lengths

3.41 DATA CLIPPING

It may prove useful to understand the mechanisms in the system which decide what part of the graphic data is displayed for any given view.

The term 'clipping' means that the system examines the data it has to display at any one time, and 'clips' off material that would not be meaningful.

There are four clipping routines used. They are scalar, zoom view, library unit, and individual data entry clipping. Optimise on display speed by bearing these in mind when compiling your drawings.

SCALAR CLIPPING

The purpose of this routine is to avoid delays which might occur when attempting to replay any graphics too small to be useful at the current zoom view. Four main parameters are involved.

- Any text below 0.7 ASCII standard scale (default text scale) will be abbreviated to a field of dots. Any text larger than 8 times standard will also not be displayed.
- Any circle with a radius of less than 1 screen point will not be calculated and will be displayed as a dot.
- Any Library Unit copied so that its base page view would be smaller than 4 x 3 screen points will not be replayed.
- Any collection of data drawn under a zoom view such that the entire zoom view is less than 4 x 3 screen points at the current screen view, will not be replayed.

SECTION THREE

ZOOM VIEW CLIPPING

When you add data to the system it is always with respect to a given zoom view. If the original zoom view does not overlap with the current view, none of the data associated with the original view is valid at the current view and is therefore ignored.

Note: This is a very fast clip. Consequently, replay of zoom views of large drawings and schematics is enhanced if the data is compiled under several local zoom views, rather than being added to your base page view at small scale.

LIBRARY UNIT CLIPPING

As with zoom view clipping, if a given Library unit has an origin and scale which ensures that it cannot comprise part of the current zoom view, it is not replayed.

DATA WINDOWING

All data may intersect with the screen boundaries. The system calculates these intersect points and displays the valid part of the data. Replay delays can be caused by zooming intensively on the edge of a nib field, a large text block or a small part of a large block of stream.

3.42 FILE STRUCTURE

The system allows Library Units as part of the definition of other Library Entries, up to 16 levels deep. This is a very powerful structure which allows edit of library items globally (every instance of a given Library Entry) or locally (a single instance).

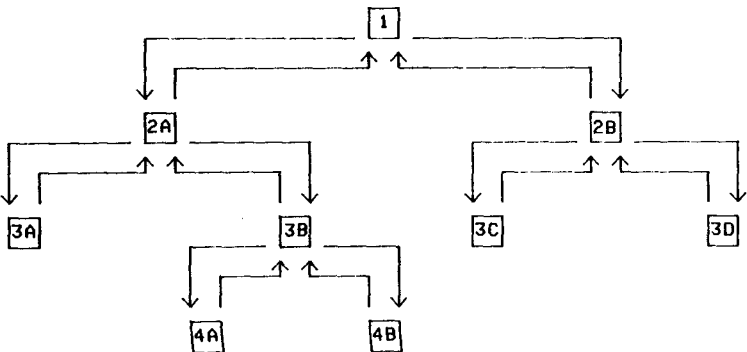

S E C T I O N T H R E E

To take advantage of these options it is useful to understand the structure of a 'nested' entry. A typical file structure is shown here.

The system will process the file from the top down and from left to right. Thus, in this example the replay sequence would be 1, 2A, 3A, 2A, 3B, 4A, 3B, 4B, 3B, 2A, 1, 2B, 3C, 2B, 3D, 2B, 1.

COMPILING LARGE FILES

When generating a large drawing which will exceed the computer memory space it is useful to note the following procedure.

On reaching the limit of useable space (indicated by the Memory Counter located at the bottom of Menu 1) FILE the drawing. WIPE the system and then COPY it back using the default grids to get it full scale screen centre. The system substitutes a pointer indicating where the data is for the data itself, freeing the on-line memory for more drawing.

Note: The early part of the drawing can now only be edited as a single unit, unless you use the LOAD routines and work on it exclusively, saving the module back into the same slot on the library.

If the process must be repeated, use ERASE to eliminate the original Library Unit already filed, then FILE only the new data added. Thus the drawing is composed of two 'equal' parts rather than one being nested within the other. After a WIPE, COPY back both components if there is a need to view them as an aid to continuing drawing.

Each Library Unit can then be considered as an overlay plane, to be added or erased at will.

This technique enables extremely large files to be constructed (up to disk capacity).

If you develop parts of the drawing separately as components (at as large a scale as possible), and only COPY them on to your finished work page as the final operation, you will achieve faster replay of zoomed views via the process of clipping.

3.43 EDITING

Every Library Unit has a unique definition based on the volume, index and slot number of the library pigeonhole.

When a library unit is updated (LOAD - edit - FILE), every instance of that component is automatically updated on any drawing on that particular Library Disk.

SECTION THREE

To update a drawing with an edited component without affecting any other drawing first generate a new version of the component (LOAD- edit - FILE in a new slot) and then use EXCH command to exchange the old component for the new edited version.

To uniquely edit an element of a component that is deep within its nested definition it is necessary to have access to all successive levels of the definition on the same Library Disk. The procedure required is detailed below.

- Load from your Work Page the complex component whose nested sub-assembly you wish to edit and file it on to a library.
- Then as often as required LOAD FROM LIBRARY, LOAD FROM WORK PAGE, and re-FILE until a LOAD FROM PAGE isolates the required level. Edit this and FILE.
- Then use EXCH to replace the old version with the new from the bottom of the nested definition upwards, re-filing as during the process. Finally, EXCH the old complex component for the new FILED version.

For example, to accomplish a unique edit of component 4B in the example file structure in Section 3.42.

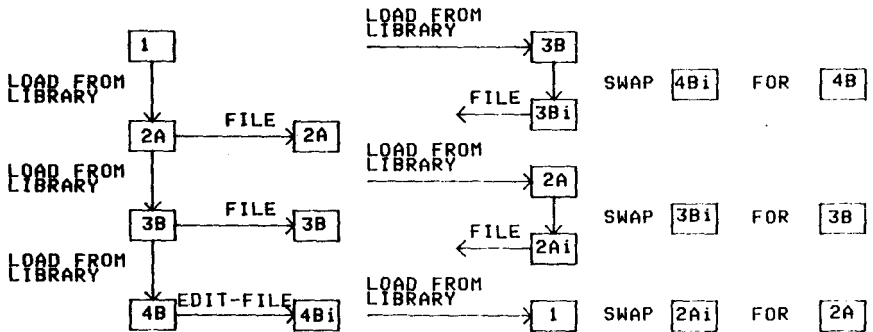

Note: It is useful to keep those components which may require editing on the same Library Disk as the finished drawing. These can then be edited directly via LOAD (from Library) and FILE (in the same box) which, as explained, automatically updates any successive nested definition with the new version.

SECTION THREE

3.44 RECORD LENGTHS

When compiling your drawings, each entry uses the following amount of memory, in bytes:

LINES	18
ARCS	26
CIRCLES	14
NIBS	34
PAINT	7
STREAM	$4 + (4*N)$ (where N = number of stream points)
TEXT	$10 + N$ (where N = number of characters)
COPY	24

S E C T I O N T H R E E

3.50 **ERROR MESSAGES**

This section gives potential error messages; describes what condition causes the error, and what recovery procedure to use.

If an error occurs, it will be displayed at the bottom of the screen. For non serious errors, press any key to return to the system.

In addition, the operating system will issue an error message if a disk-related error occurs. Refer to the BBC Microcomputer documentation for explanation, if this type of error occurs. To recover press RETURN key, or if a serious error, reload the Systems Master.

3.50.1 **ILLEGAL FILE**

CAUSE This condition occurs when an attempt is made to FILE a Work Page over an existing Library Unit which is contained within the page being filed.

ACTION Press RETURN key to continue, and select another slot in which to FILE the Library Unit.

3.50.2 **SERIOUS SYSTEM ERROR**

CAUSE This condition is signalled if serious data corruption, or apparent corruption, occurs during a drawing session. For example, by changing a Buffer Disk in the middle of a drawing session.

ACTION Press RETURN key to continue. If the system can recover, proceed as before. Otherwise it will be necessary to reload the System Master.

3.50.3 **LIBRARY DISK FULL**

CAUSE This condition occurs if there is no further space for catalog entries on the current Library Disk.

ACTION Press RETURN key to continue, then use another Library Disk as storage to save the drawing.

3.50.4 **NOT LIBRARY DISK**

CAUSE This condition occurs when an attempt is made to FILE, COPY, or LOAD from, or to a non-library disk.

ACTION Press RETURN key to continue. Replace the disk with the required library disk.

S E C T I O N T H R E E

3.50.5 PICTURE TOO COMPLEX

CAUSE This condition occurs when attempting a replay which would cause the maximum allowed depth of 'nesting' of components to be exceeded.

ACTION Press RETURN key to continue.

3.50.6 DIRECTORY WRITE ERROR

CAUSE This condition occurs if the system data directory has been corrupted during processing.

ACTION Press RETURN key to continue. Exit to the System Menu and select 'RECOVER LIBRARY DISK' (Option 8).

3.50.7 NO ROOM ON DISK

CAUSE This condition occurs when there is no more space on the disk.

ACTION Press RETURN key to continue. Replace the disk with a new formatted disk.

I N D E X

0-90 degree locks	95	default grid locks	159
8 X 6	111,159	default palette	135
8 X 8	111,159	deleting an image	86
A		directory error	167
analogue input	2	disk drive usage	14
angle locks	89,92,139, 156	DNFS	1
angled nib	46	draw	15,137
animation	33	draw palette	9
archive disk	3,134	drive 0	14
arcs	36,39,41, 42,165	drive 2	14
arcs and lines	39	dupl	149
arcs in free space	138	duplicate	19,73,149
assign angle locks	156	duplicating units	73
assign grid locks	158	dynamic cursor	9
automatic grids	103	E	
B		editing drawings	163
backup	19	ellipses	28
BASIC	1	enter label	20
box location	122	erase	16,146
buffer disk	3,134	erase colour	33
C		erase cursor	146
cancelling a lock	90	erase library units	24
catalog images	86,154	error messages	166
change palette	132,135	escape from palette	13
changing grid	102	escaping from lock	90
changing library	14	exch	149
choosing index boxes	123	exchange	19,74,149, 164
circles	26,139,165	exchange units	75,80
clipping data	161	F	
coarse angle locks	94	fast pan	60
colour leakage	33,141	file	19,20,143
colour of text	142	file structure	162
compact library disk	132,136	filing drawings	19
compass arc	41,118,138	filing library units	81
concentric arcs	42	find	34,104,147
continuous erase	147	finding a point	34
controller	1,8	format archive disk	124,132
controller commands	8	format buffer disk	132
copy	18,21,143, 165	format data disks	133
copy cursor	21,148	format library disk	123,133
copy palette	149	freehand drawing	51
copy with angle lock	158	freehand with lock	91
creating large files	163	fullsize	153
D		G	
data clipping	161	graphics rom	2
de-zooming	64	grid display	97
default angle locks	157	grid divisions	98
		grid locks	89,158
		grid size	98
		grid spacing	100
		grid unknown angle	106

I N D E X

I		N	
illegal file	166	n-tan	95,157
index a	122	nested library units	143
index b	122	nib	140,165
index c	122	nib cursor	44,140
installation	1	nib drawing	44
intersection points	125	nib selection	44
introductory library	3	nib spacing	47
inverse zoom	150	no room on disk	167
isometric grids	109	non orthogonal grids	159,160
		normal tangent locks	95
L		O	
L	8	operating system	1
L and R	8	origin cursor	9
L and T	8	ortho	157
label	20,143	orthogonal grids	160
large files	163	overpainting	33
library copy ratios	115		
library disk full	166	P	
library disk storage	122	page	17,151
library disk system	121	paint	32,140,165
library disks	18,123,133	paint with printer	33
library index	18,121	palette	12
library line type	69,145	pan	58,150
library number	123	photography	88
library recursion	83	picture too complex	167
library unit clip	162	pixels	97
library unit colour	68,145	plotter	2
library units	61	points	137
line colour	29	precision drafting	89,156
line type	31	predrawn libraries	124
lines	137,165	preset grids	111
load	151	print image	154
load from library	76,152,163	printer	2
load from work page	77,152,163	printing an image	87
loading an image	86,154		
lock override	156,158		
locked grids	97		
locks	89		
		R	
M		R	8
manual grid position	102	radial lines	127
memory counter	11	recover library disk	136
menu 1	9,10	registration grids	112
menu 2	10,156	removing the menu	87
modify library units	76	removing the palette	87
modify page units	77	restore library disk	132
move	71,148	restore palette	132,135
moving units around	72	reverse zoom	64,150
multi unit exchange	81	reversing arcs	43
		rot	144
		rotating a grid	104
		rotation	22,144
		run graphics program	132

I N D E X

S		W	
save	154	windowing data	162
save image	154	wipe	17,155
saving an image	85	work page	9,19,151
scalar clipping	161		
scale	22,144		
schematic layout	113	X	
scl	22,144	x dimension	97
screen images	120,151	x-flip	67,145
screen resolution	120	XY	8
second angle lock	157		
security	10	Y	
select drive	151,155	y dimension	97
select library	151	y-flip	67,145
serious system error	166		
single unit exchange	80	Z	
skewed grids	107	Z	8
starting the system	4	zoom	57,61,150
str	22,144	zoom cursor	159
straight arcs	38	zoom store	64,151,153
stream mode	141,165	zoom store load	66
stretch	22,144	zoom view clipping	162
suppressing a lock	90	zoom window	150
symmetry	129	zoom with a grid	115
system components	1	zoom with locks	159
system error	166		
system master disk	3		
system menu	5		
system reset	155		
 T			
T	8		
tan arc	95		
tangent arcs	36,138,117		
text	51,55,142, 165		
text display	53		
text from keyboard	51		
text from library	55		
text with grid	142		
trace	50,141		
tracing	50		
 U			
using all the screen	87		
utilities	151		
utils	66,76,85, 151		
 V			
vernier locks	92		
video recording	88		



Acorn Computers Limited, Fulbourn Road, Cherry Hinton, Cambridge CB1 4JN